



Product Catalogue

2022-23 Edition

- Labels
- Signage
- Name Badges
- Home & Office Accessories & Tools

Why Avery Labels?

Our labels, your world.

Avery has a range of labels for your every need. Unique features and the best quality ensure your label works every time.

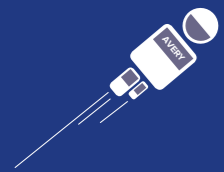

Sure Feed®

Prevents jamming in the printer when printing so your labels should fly through the printer. Stick with Avery – the premium self-adhesive label manufacturer.



Quick Peel

Effortlessly peel labels from the backing sheets, making it easier with less wastage, less time required.



Free Templates

Enables you to create professional labels and cards from your home and office, quickly and easily to make you stand out.

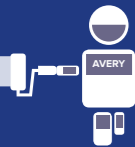

Trueblock

Blocks and covers everything underneath so you can reuse and recycle packaging materials with ease.



Stay Stuck

Avery superior quality adhesive means when you stick an Avery label you can be certain it stays stuck.



Different Shapes and Sizes

With our vast range of labels sizes, shapes, materials and pack quantities there is no job too big or too small to accomplish.



Introduction to Avery Materials	2
Label Size Guide	6
Labels	12
Address Labels	13
Shipping & Parcel Labels	16
Eco Friendly Labels	19
High Visibility Labels	21
Clear Labels	22
Filing Labels	23
Round Labels	25
Square Labels	25
Rectangle Labels	26
Oval Labels	27
Wrap-Around Labels	28
Arch Labels	28
CD Labels	28
Scallop Labels	28
Coloured Labels	29
Dispenser Labels	30
Dot Matrix	34
Roll Address Labels	34
Thermal Roll Labels	34
Small Pack Labels	35
Our Best Sellers	37
Avery General Use Labels	38
Heavy Duty Labels	39
Heavy Duty Labels	40
Security Labels	44
Cable Markers	44
Self-Laminating Labels	45
Warehouse Labels	46
Antimicrobial Film	47
Home Organisation	49
Organisation & Storage Labels	50
Adhesive Pocket	53
Magnets	53
Clothing Labels	54
T-Shirt Transfers & Printable Fabric Sheets	54
Kids School Name Labels	55
Education	56
Lateral Filing	59
Files & Wallets	61
File Racks	67
Filing Labels	68
Colour Coding Labels	68
Starter Kits & Packages	74
Cabinet Packages	76
Filing & Dividers	78
Manilla Files	79
Files with Fasteners	81
Fasteners	83
Print and Apply Dividers	85
Pre-Printed Dividers	87
Manilla Board Dividers	90
Conferencing	91
Fabric Name Badge Labels	92
Name Badge Cards	92
Event Cards	93
Business Cards	95
Presentation	98
Tags	104
Food Rotation Labels	109
Day Labels	110
Dispenser	111
Allergy Labels	111
Avery Terminology	112
Our Commitment to Sustainability	116



Matt White Paper with Sure Feed®

Made from special coated matt white woodfree printing paper with a smooth, microporous surface structure and our patented Sure Feed technology for a more reliable feed through your printer.

LASER/INKJET COMPATIBLE



Trueblock®

Featuring a unique opaque silver backing that completely covers up existing labels or previous information on parcels or boxes. Trueblock® Labels are unaffected by temperature variations -40°C to +149°C.

LASER/INKJET COMPATIBLE



Removable

Made from woodfree machine finished paper, Removable Labels are unaffected by temperature variations -10°C to +70°C. The general purpose removable adhesive adheres securely to any smooth surface and can be easily removed when needed, making them ideal for temporary identification.

LASER/INKJET COMPATIBLE



Matt

Made from special coated matt white woodfree printing paper with a smooth, microporous surface structure. Matt Labels are unaffected by temperature variations from -20°C to +80°C and are made with permanent acrylic based adhesive which permits use to glass, plastic and paper surfaces.

LASER/INKJET COMPATIBLE



Gloss

Made from special coated gloss finished paper, Gloss Labels are unaffected by temperature variations -20°C to +100°C. The permanent adhesive on these labels permits use on glass, metal, plastic and paper surfaces.

LASER/INKJET COMPATIBLE



Crystal Clear

Made from a gloss transparent PET film with toner receptive top coating, making these labels dirt and tear-resistant. Crystal Clear Labels are unaffected by temperature variations from -20°C to +80°C and the permanent adhesive permits use on glass, plastic, metal and paper.

LASER COMPATIBLE

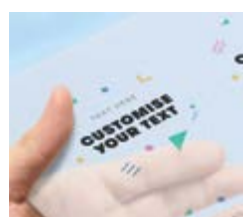

Frosted Clear

Made from Clear PET Film, these Frosted Clear labels are unaffected by temperature variations -53°C to +93°C. Ideal for adding elegance to dark coloured and patterned envelopes especially for use at corporate events and for wedding invitations.

INKJET COMPATIBLE

The above images are for demonstration purposes only. Not all materials listed above are available in a round label. Please refer to the catalogue or contact our friendly customer service team to confirm.

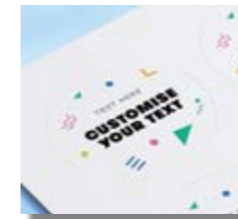

Eco Friendly

Made from white uncoated paper from 100% recycled fibres so you can be sure you are doing your bit to help the environment. Enviro Labels are unaffected by temperature variations -20°C to +100°C and are made with water soluble adhesive.

LASER COMPATIBLE

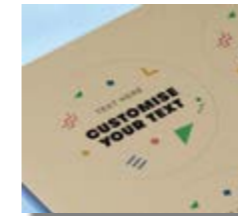

Kraft Brown

Made from light brown uncoated matt paper. Kraft Brown Labels are unaffected by temperature variations -40°C to 150°C and the permanent adhesive permits use on glass, plastic and paper.

LASER/INKJET COMPATIBLE

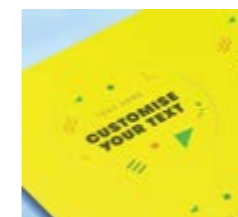

Fluro

Made from fluorescent coated woodfree paper available in orange, yellow, pink and green. Fluro labels are unaffected by temperature variations -20°C - +80°C. The permanent acrylic based adhesive and bright colours are ideal for inventory labels, warning labels, eye-catching advertising and promotional labels.

LASER COMPATIBLE

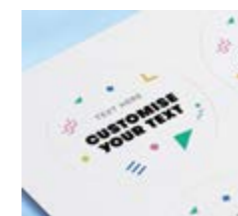

Fabric

Made from white acetate satin fabric with high opacity and lustrous finish. Fabric labels are unaffected by temperature variations -40°C - +90°C. The permanent acrylic based adhesive stays adhered throughout movement and removes cleanly on a variety of materials including textiles, mattresses, shoes and carpets.

LASER COMPATIBLE

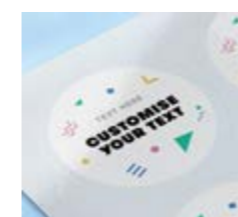

Self-Laminating

Made from polyester material featuring excellent tear strength, heat resistance, dimensional stability and chemical resistance. Self-Laminating Labels are unaffected by temperature variations from -40°C to 150°C and the permanent adhesive permits use on plastics, bare/coated/painted metals and outdoor industrial applications.

LASER/INKJET COMPATIBLE

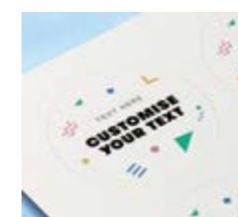

Textured Linen

Made from white uncoated matt paper with a textured finish similar to linen material. Textured Linen labels are unaffected by temperature variations -53°C - +93°C. The permanent adhesive permits use to glass, plastic and paper surfaces.

LASER/INKJET COMPATIBLE

The above images are for demonstration purposes only. Not all materials listed above are available in a round label. Please refer to the catalogue or contact our friendly customer service team to confirm.

HEAVY DUTY MATERIALS

Avery Heavy Duty labels are engineered to withstand harsh environments that a standard paper label can't endure.



White Heavy Duty

LASER/INKJET COMPATIBLE

Made from polyester material they are oil, dirt and water resistant and tear-proof. White Heavy Duty Labels are unaffected by temperature variations from -20°C to +80°C and the permanent adhesive permits use to metal, plastic, painted surfaces, polycarbonate and glass.



NoPeel™

LASER COMPATIBLE

Made from acrylic they are oil, dirt and water resistant and tear-proof. NoPeel™ Labels are unaffected by temperature variations -40°C to +100°C and the permanent adhesion permits use to laptops, tablets, mobiles, computers, computer screens and office equipment. These tamper-evident security labels are permanent and are designed not to peel off. If an attempt has been made to remove the label, the material flakes and disintegrates, making removal virtually impossible and tampering immediately obvious.



Heavy Duty Removable

LASER COMPATIBLE

Made from polyester material they are oil, dirt and weather resistant as well as tear-proof. These Removable Labels are unaffected by temperature variations -20°C to +80°C and are ideal for creating temporary labelling of equipment, facilities and storage supplies, stock take and organising workshops.



TripleBond™

LASER COMPATIBLE

Made from polyester material they are oil, dirt and water resistant and tear-proof. TripleBond™ Labels are unaffected by temperature variations from -40°C to +100°C and the permanent adhesion permits use to metal and plastic even if the surface is difficult e.g. hot, cold or rough.



Silver Heavy Duty

LASER COMPATIBLE

Made from polyester material they are oil, dirt and water resistant and tear-proof. Silver Heavy Duty Labels are unaffected by temperature variations from -40°C to +150°C and the permanent adhesive permits use to metal, plastic, painted surfaces, polycarbonate and glass.



Ultra-Resistant Outdoor

LASER COMPATIBLE

Made from a polyethylene film with a strong adhesion they are resistant to UV, weather, saltwater and chemicals. Ultra-Resistant Outdoor Labels are unaffected by temperature variations -40°C to +150°C and the strong adhesion permits use to metal, plastic, painted surfaces, polycarbonate and glass.

HOW ARE HEAVY DUTY LABELS DIFFERENT?

Avery understands there is a significant difference in adhesion strength and material requirements when labelling.

The construction of an Avery Heavy Duty label ensures the labels adhere to a variety of substrates such as metal, wood (pallets), glass and plastic. They have an extra layer of plastic film for increased strength and durability.

These labels are engineered to withstand the range of conditions and hazards found in harsh environments such as warehousing and logistics, manufacturing, laboratories and construction sites.

These labels can be used for everything from safety signage to chemical labels, asset management and inventory control.

PAPER

FACESTOCK

Copy / print paper

ADHESIVE

General purpose

LINER

Calendered craft paper

HEAVY DUTY

HEAVY DUTY LINER

Robust machine finished paper / high-speed print capable

ADHESIVE

High peel strength / exceptional facestock anchorage / suitable for harsh environments

FACESTOCK

Engineered plastic Film / chemical resistant / heat resistant / high tear strength / suitable for harsh environments

TOPCOAT

High abrasion resistance / high print quality / broad printer compatibility

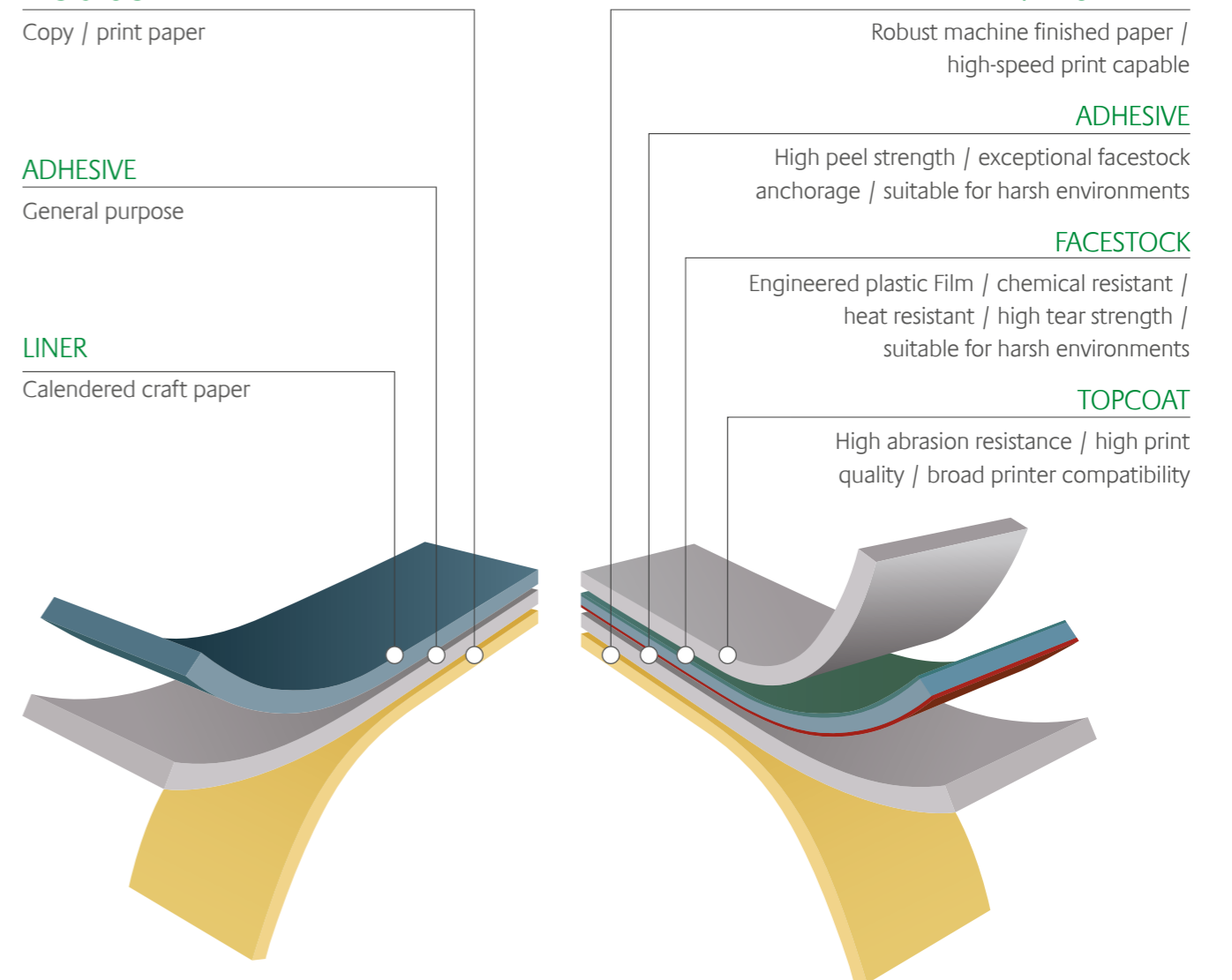

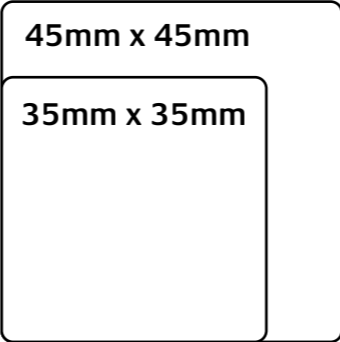
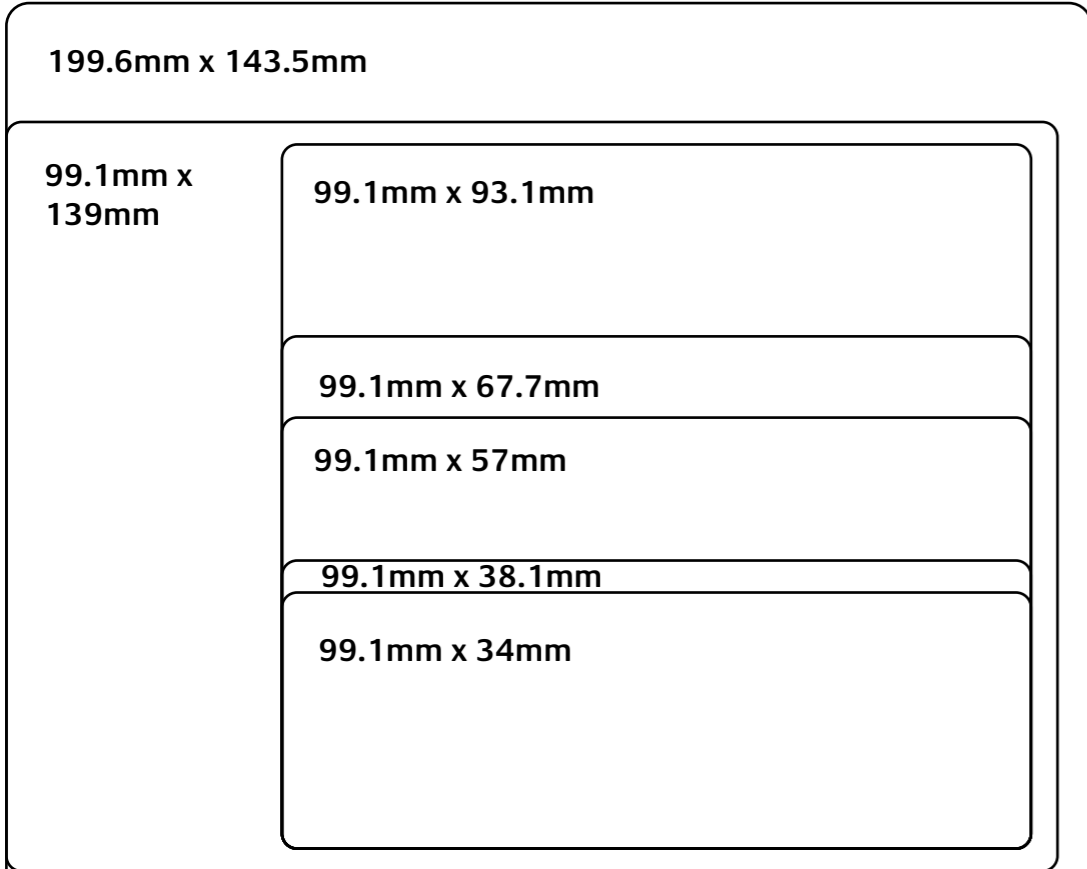

2 large size:
197.6mm x 289.1mm
208mm x 295mm
not shown.

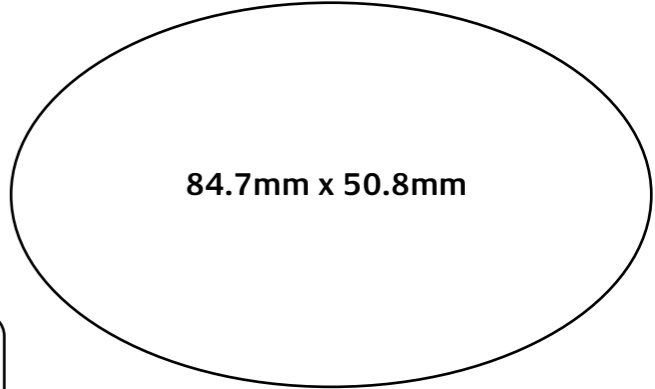
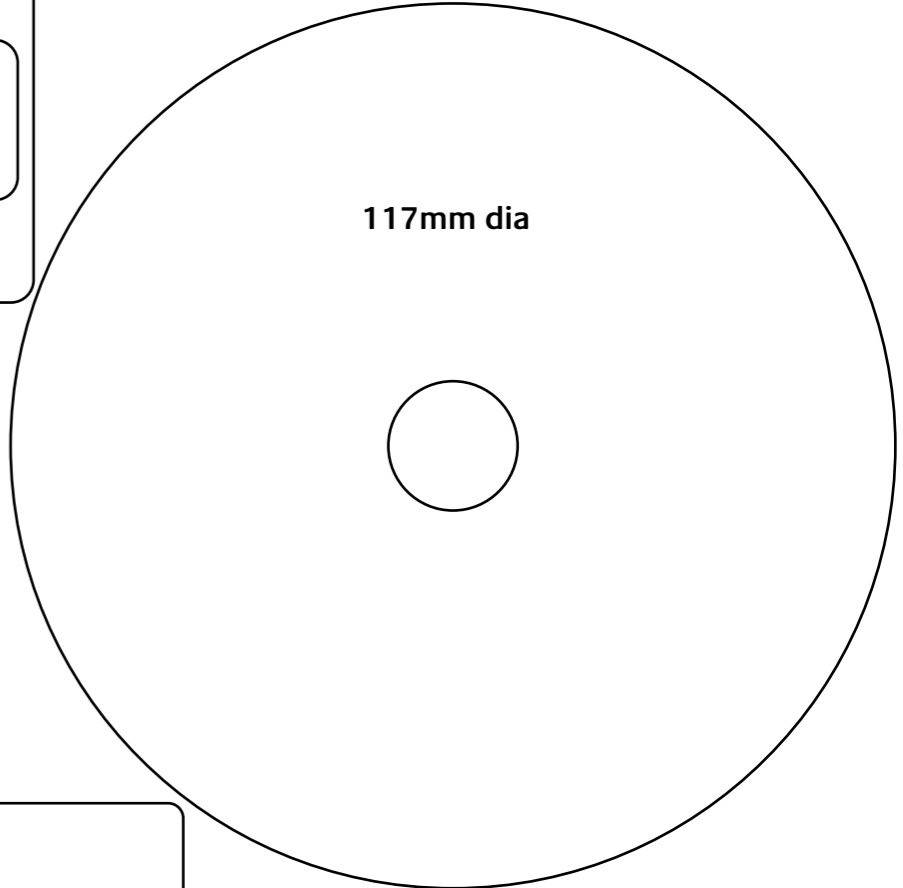
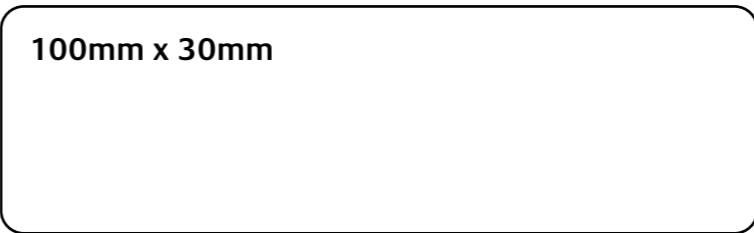
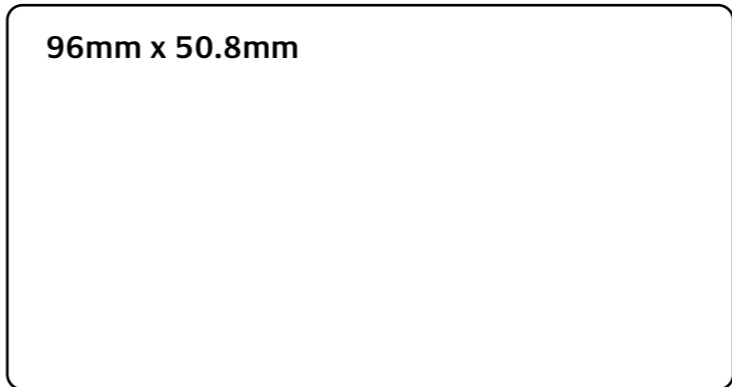
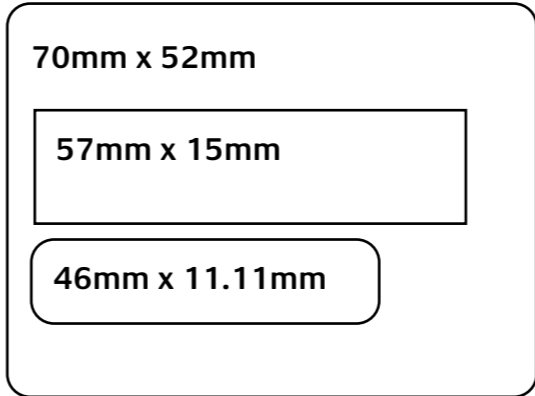
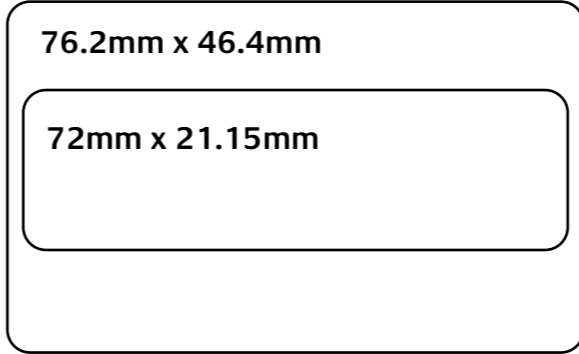
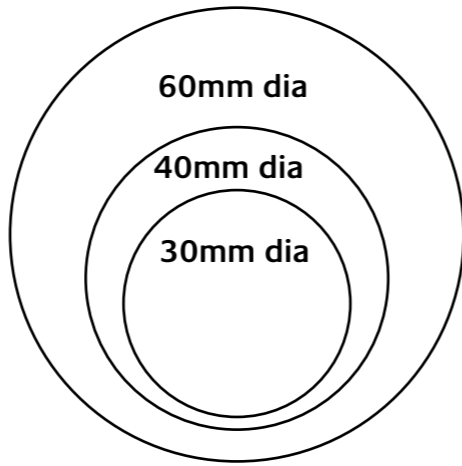
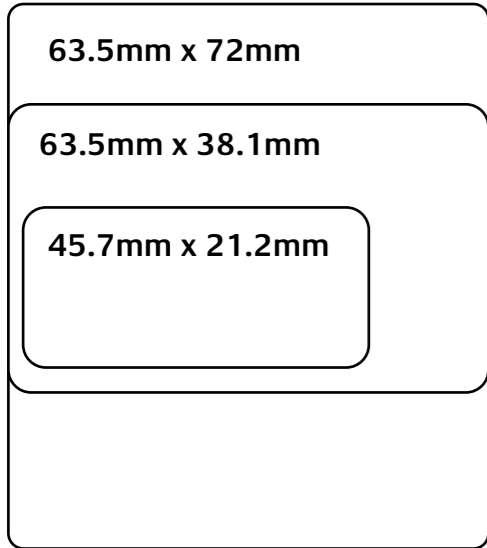
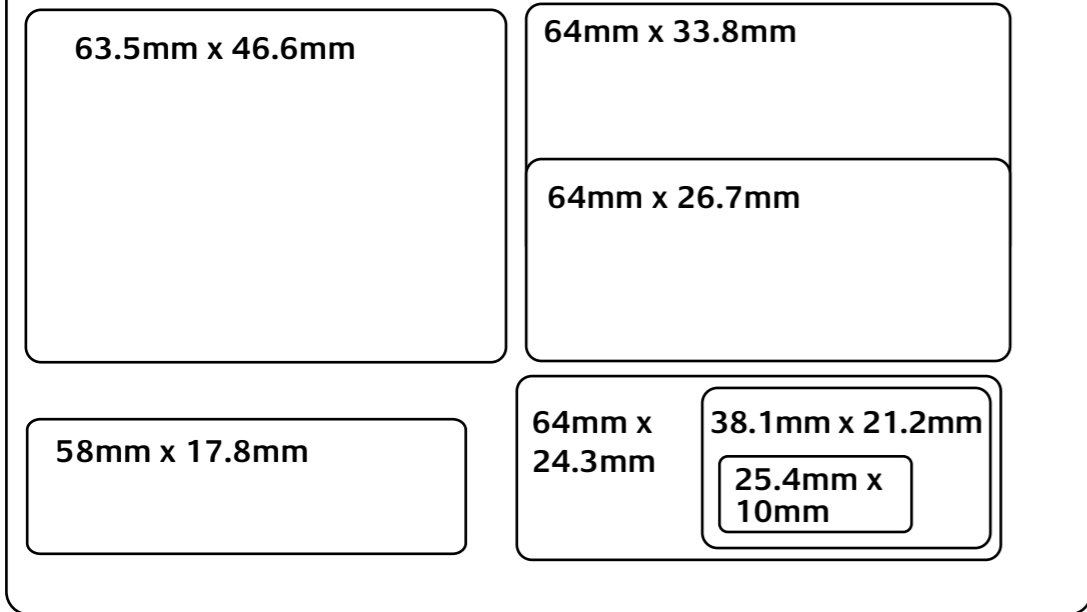

200.7mm x 93.1mm

200mm x 60mm

196mm x 51mm

99.1mm x 42.3mm

80mm x 35mm

45.7mm x 25.4mm

182mm x 130mm

62mm x 89mm

62mm x 42mm

96mm x 51mm

94mm x 32mm

63.5mm x 33.9mm

63.5mm x 24mm

64mm x 30.5mm

63.5mm x 29.6mm

210mm x 148mm

105mm x 148mm

190mm
x
16mm

200mm x 44.5mm

89mm x 120.7mm

57.2mm x 77mm

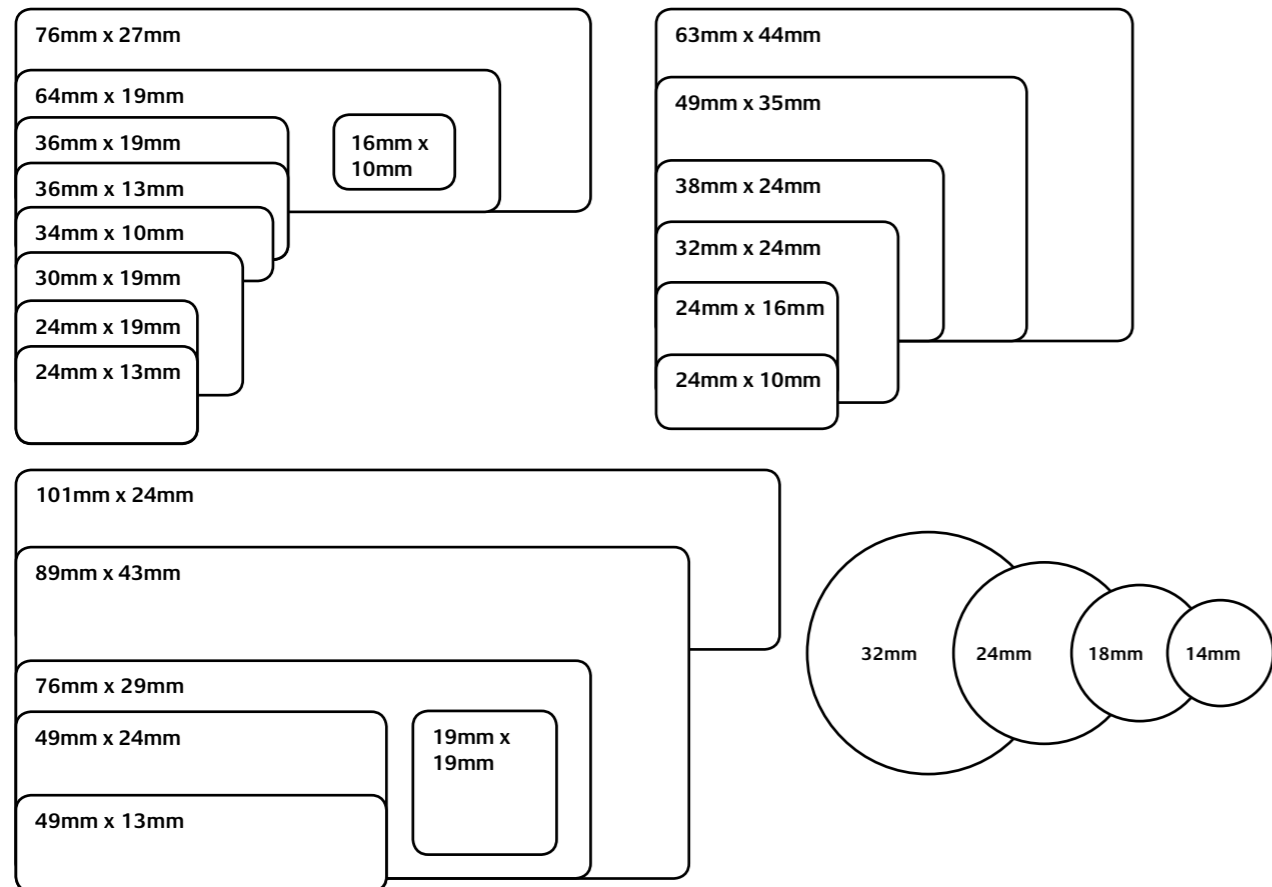

Sticker Size Guide

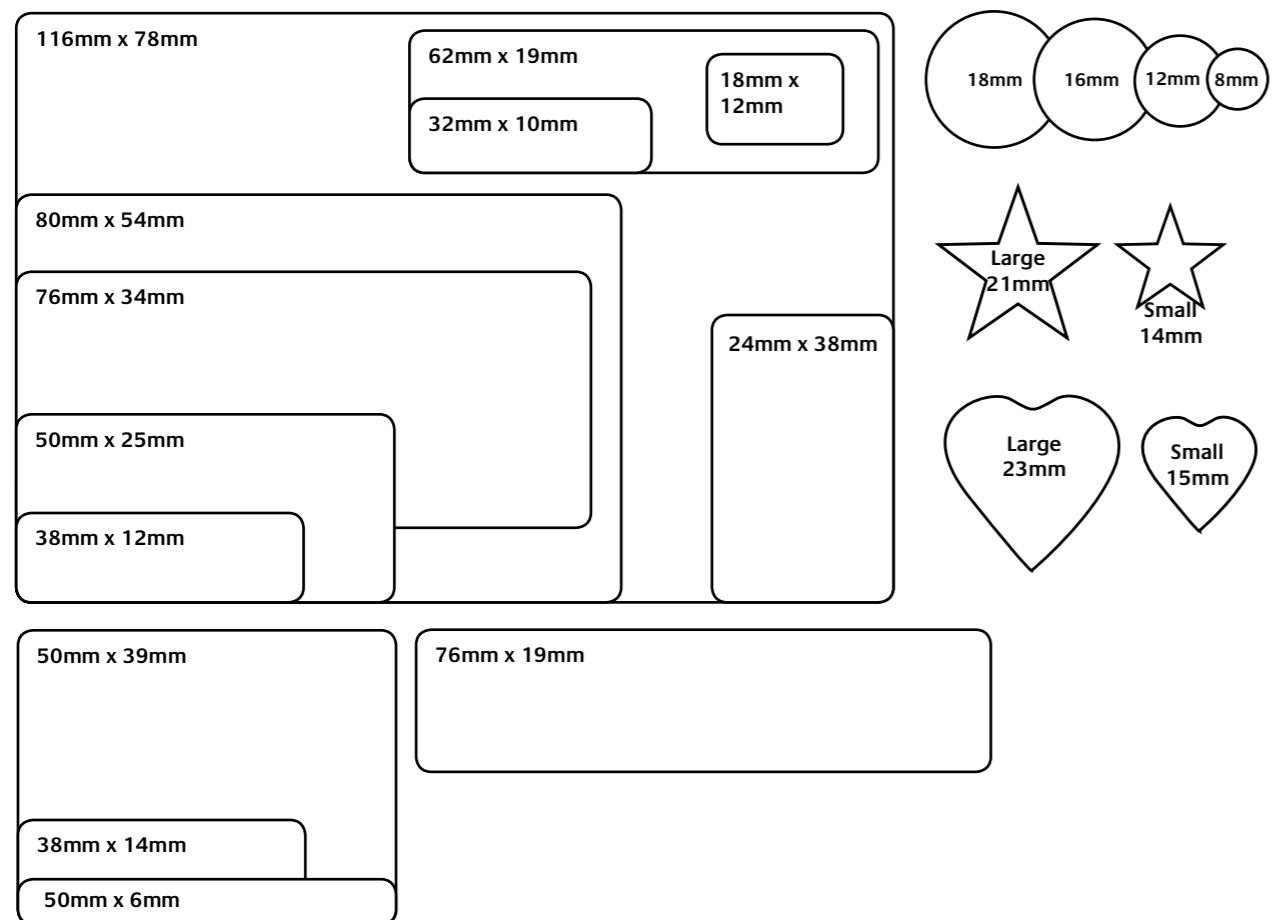

DESIGN. PRINT. GO!®

Create & print your own professional labels in minutes:

averyproducts.com.au/print

- Choose from hundreds of free fully customisable templates or upload your own artwork
- Importing your contacts or data is a breeze with our powerful mail merge functions
- Save your projects online or on your own computer



Labels

Whether you need to send mail out fast or organise your office, we've got the right label for you!

Our comprehensive label range will help save you time at work and at home. With FREE template software available at Avery Design & Print you can design and print your labels with ease.

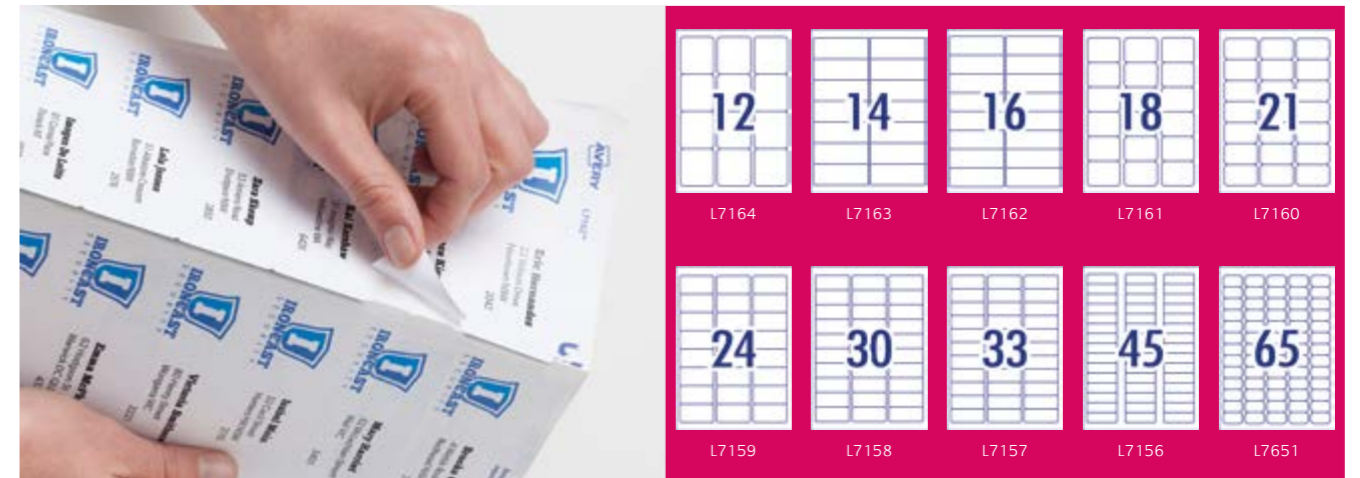

Address Labels with Sure Feed® Laser

- Address labels are designed for use anywhere you frequently print your own mailing labels
- Labels feature Sure Feed®, which helps to minimise waste and inefficiency during printing by ensuring a reliable feed and accurate print alignment
- Labels feature Quick Peel® to ensure quick and easy detachment from the backing sheet for efficient application
- Superior adhesive withstands the high heat of laser printers
- Customise your labels with our free and easy-to-use template software: Avery Design and Print – available at averyproducts.com.au/print
- FSC® certified labels made with paper from well-managed forests and other controlled sources

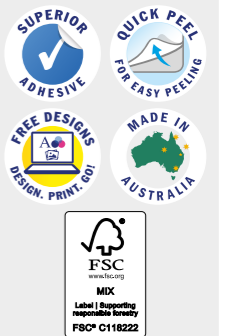

Code	Software Code	Colour	Size	Labels per Sheet	Sheets per Pack	Labels per Pack
Small Packs						
952003	L7163	White	99.1 x 38.1mm	14	20	280
952002	L7162	White	99.1 x 34mm	16	20	320
952001	L7161	White	63.5 x 46.6mm	18	20	360
952000	L7160	White	63.5 x 38.1mm	21	20	420
959012	L7651	White	38.1 x 21.2mm	65	25	1625
Medium Packs						
959110	L7163	White	99.1 x 38.1mm	14	40	560
959111	L7162	White	99.1 x 34mm	16	40	640
959113	L7159	White	64 x 33.8mm	24	40	960
959115	L7651	White	38.1 x 21.2mm	65	40	2600
Large Packs						
959005	L7164	White	63.5 x 72mm	12	100	1200
959004	L7163	White	99.1 x 38.1mm	14	100	1400
959003	L7162	White	99.1 x 34mm	16	100	1600
959002	L7161	White	63.5 x 46.6mm	18	100	1800
959001	L7160	White	63.5 x 38.1mm	21	100	2100
959029	L7159	White	64 x 33.8mm	24	100	2400
959062	L7158	White	64 x 26.7mm	30	100	3000
959060	L7157	White	64 x 24.3mm	33	100	3300
959061	L7156	White	58 x 17.8mm	45	100	4500
959071	L7651	White	38.1 x 21.2mm	65	100	6500



Address Labels with Sure Feed® Laser / Inkjet

- Address labels are designed for use anywhere you frequently print your own mailing labels
- Labels feature Sure Feed®, which helps to minimise waste and inefficiency during printing by ensuring a reliable feed and accurate print alignment
- Labels feature Quick Peel® to ensure quick and easy detachment from the backing sheet for efficient application
- Inkjet label paper is optimised for a smudge free professional finish
- Customise your labels with our free and easy-to-use template software; Avery Design and Print – available at averyproducts.com.au/print
- FSC® certified labels made with paper from well-managed forests and other controlled sources



Code	Software Code	Colour	Size	Labels per Sheet	Sheets per Pack	Labels per Pack
959417	L7163	White	99.1 x 38.1mm	14	10	140
959418	L7159	White	64 x 33.8mm	24	10	240
959419	L7651	White	38.1 x 21.2mm	65	10	650



Address Labels with Sure Feed® Inkjet

- Address labels are designed for use anywhere you frequently print your own mailing labels
- Labels feature Sure Feed®, which helps to minimise waste and inefficiency during printing by ensuring a reliable feed and accurate print alignment
- Labels feature Quick Peel® to ensure quick and easy detachment from the backing sheet for efficient application
- The inkjet label material is optimised for a smudge free professional finish
- Strong superior adhesive
- Customise your labels with our free and easy-to-use template software; Avery Design and Print – available at averyproducts.com.au/print
- FSC® certified labels made with paper from well-managed forests and other controlled sources



Code	Software Code	Colour	Size	Labels per Sheet	Sheets per Pack	Labels per Pack
Small Packs						
936078	J8163	White	99.1 x 38.1mm	14	25	350
936079	J8162	White	99.1 x 34mm	16	25	400
936082	J8160	White	63.5 x 38.1mm	21	25	525
936104	J8159	White	64 x 33.8mm	24	25	600
936109	J8157	White	64 x 24.3mm	33	25	825
936084	J8651	White	38.1 x 21.2mm	65	25	1625
Large Packs						
936116	J8164	White	63.5 x 72mm	12	50	600
936094	J8163	White	99.1 x 38.1mm	14	50	700
936098	J8162	White	99.1 x 34mm	16	50	800
936096	J8161	White	63.5 x 46.6mm	18	50	900
936097	J8160	White	63.5 x 38.1mm	21	50	1050
936107	J8159	White	64 x 33.8mm	24	50	1200
936106	J8158	White	64 x 26.7mm	30	50	1500
936108	J8157	White	64 x 24.3mm	33	50	1650
936111	J8156	White	58 x 17.8mm	45	50	2250
936099	J8651	White	38.1 x 21.2mm	65	50	3250

Did you know?

Return address labels not only prevent mail from getting lost in the post, it's also another way of reinforcing that the item is from a professional and trusted outlet which helps to encourage recipients to act.

Adding your logo to an address label gives confidence that the package is from a trusted source. Adding icons and images, bold colours and handwritten fonts all proved successful in our label experiments.



Address Labels with Smooth Feed Laser

- Smooth Feed Sheet Edges are suited for high speed printers
- Jam-Free reliability for trouble free printing on Laser printers, saving time and minimising wastage
- Customise your labels with our free and easy-to-use template software; Avery Design and Print – available at averyproducts.com.au/print
- Special adhesive withstands the high heat of laser printers
- FSC® certified labels made with paper from well-managed forests and other controlled sources



Code	Software Code	Colour	Size	Labels per Sheet	Sheets per Pack	Labels per Pack
959304	L7163	White	99.1 x 38.1mm	14	100	1400
959329	L7159	White	64 x 33.8mm	24	100	2400
959360	L7157	White	64 x 24.3mm	33	100	3300
959371	L7651	White	38.1 x 21.2mm	65	100	6500
Bulk Packs						
959089	L7163	White	99.1 x 38.1mm	14	250	3500
959090	L7160	White	63.5 x 38.1mm	21	250	5250

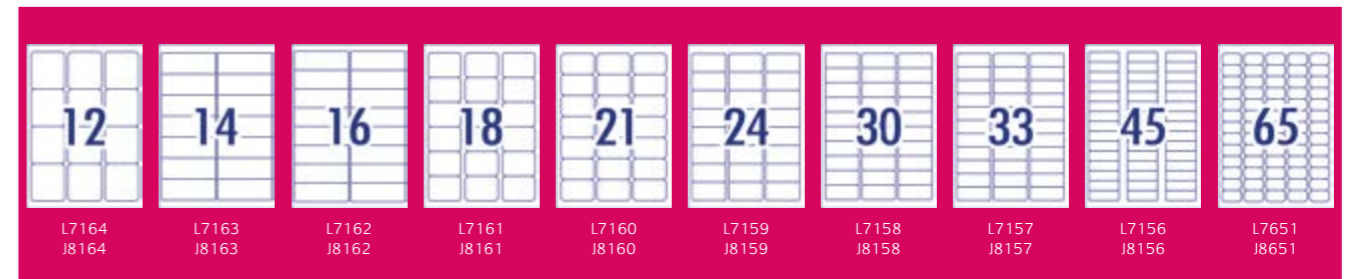

Did you know? It pays to place the label in the centre of your item and to place the most important information in the centre of the label. Be careful not to crowd this area of the label with too much information.



Avery helps make office and workplace organising activities professional and easy.

Look for our new Sure Feed Technology on our Address Labels range for a reliable printer feed every time.



Shipping Labels with Trueblock® Laser / Inkjet

- Trueblock® labels feature an opaque silver backing which completely covers up existing labels or previous information on parcels or boxes
- Jam-Free reliability for trouble free printing, saving time and minimising wastage
- Customise your labels with our free and easy-to-use template software; Avery Design and Print – available at averyproducts.com.au/print
- FSC® certified labels made with paper from well-managed forests and other controlled sources



Code	Software Code	Colour	Size	Labels per Sheet	Sheets per Pack	Labels per Pack
Small Packs						
959400	L7167	White	199.6 x 289.1mm	1	10	10
959401	L7168	White	199.6 x 143.5mm	2	10	20
959402	L7169	White	99.1 x 139mm	4	10	40
959403 BEST SELLER	L7165	White	99.1 x 67.7mm	8	10	80
952007	L7167	White	199.6 x 289.1mm	1	20	20
959406*	L7175	White	105x148mm (A6)	1	25	25
952008	L7168	White	199.6 x 143.5mm	2	25	50
Large Packs						
959009	L7167	White	199.6 x 289.1mm	1	100	100
959008 BEST SELLER	L7168	White	199.6 x 143.5mm	2	100	200
959013	L7155	White	200.7 x 93.1mm	3	100	300
959030 BEST SELLER	L7169	White	99.1 x 139mm	4	100	400
959007 BEST SELLER	L7166	White	99.1 x 93.1mm	6	100	600
959006	L7165	White	99.1 x 67.7mm	8	100	800
959031	L7173	White	99.1 x 57mm	10	100	1000
Bulk Packs						
959091	L7167	White	199.6 x 289.1mm	1	250	250
959092	L7168	White	199.6 x 143.5mm	2	250	500
959093	L7169	White	99.1 x 139mm	4	250	1000
959094	L7165	White	99.1 x 67.7mm	8	250	2000

*A6 labels allow you to print one label at a time.



Shipping Labels Inkjet

- Leave a lasting impression with your mailing solutions using Avery Shipping Labels
- They're great for parcels, packages, large boxes, envelopes, mailing tubes, and more
- The inkjet label material is optimised for a smudge free professional finish
- Strong superior adhesive
- Customise your labels with our free and easy-to-use template software; Avery Design and Print – available at averyproducts.com.au/print
- FSC® certified labels made with paper from well-managed forests and other controlled resources



Code	Software Code	Colour	Size	Labels per Sheet	Sheets per Pack	Labels per Pack
Small Packs						
936070	J8167	White	199.6 x 289.1mm	1	25	25
936071	J8168	White	199.6 x 143.5mm	2	25	50
936072	J8169	White	99.1 x 139mm	4	25	100
936074	J8165	White	99.1 x 67.7mm	8	25	200
Large Packs						
936085	J8167	White	199.6 x 289.1mm	1	50	50
936086	J8168	White	199.6 x 143.5mm	2	50	100
936087	J8169	White	99.1 x 139mm	4	50	200
936088	J8166	White	99.1 x 93.1mm	6	50	300
936089	J8165	White	99.1 x 67.7mm	8	50	400

Did you know?

Using emotional imagery or words on labels engages consumers on a primal level and leads to higher interest and greater likelihood of purchase or customer loyalty.

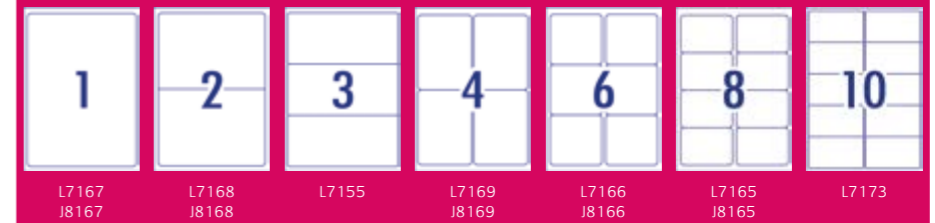



Weatherproof Shipping Labels

Avery WeatherProof Labels make shipping easy. They stand up to tough weather and temperature conditions and resist scuffs, tears and smudges so they remain easy to read.

- Shipping Labels are a stylish way of addressing your packages and parcels
- Durable, water-resistant labels provide strong protection against harsh elements
- Customise your labels with our free and easy-to-use template software; Avery Design and Print – available at averyproducts.com.au/print
- Compatible with laser printers



Code	Software Code	Colour	Size	Labels per Sheet	Sheets per Pack	Labels per Pack
959412	L7072	White	199.6 x 143.5mm	2	10	20
959411	L7071	White	99.1 x 139mm	4	10	40
959413	L7073	White	99.1 x 38.1mm	14	10	140
959409	L7070	White	99.1 x 67.7mm	8	10	80



Kraft Brown Shipping Labels Laser / Inkjet

- Kraft Brown labels blend onto cardboard and completely block out what is underneath, allowing you to re-use old boxes and parcels
- The label paper is made of 100% recycled material, processed chlorine-free and is recyclable
- Customise your labels with our free and easy-to-use template software; Avery Design and Print – available at averyproducts.com.au/print
- Ship more efficiently and reduce your impact on the environment



Code	Software Code	Colour	Size	Labels per Sheet	Sheets per Pack	Labels per Pack
959410	L7185	Kraft Brown	105 x 148mm (A6)	1	20	20
959125	L7168	Kraft Brown	199.6 x 143.5mm	2	20	40

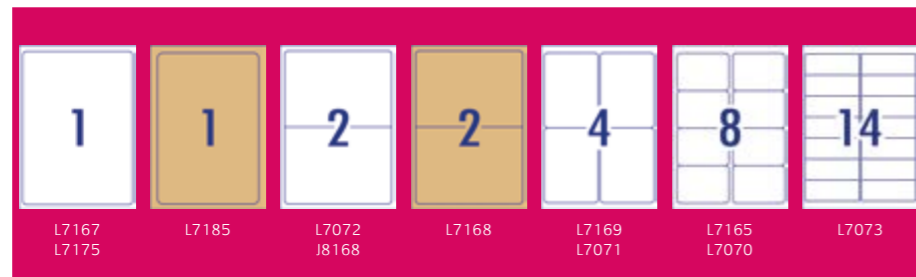

Eco Friendly Labels Laser

- Labels made from environmentally friendly recycled material
- Labels utilise water soluble eco-friendly adhesive
- The packaging and label can be recycled
- FSC® certified labels made with paper from well-managed forests
- Customise your labels with our free and easy-to-use template software; Avery Design and Print – available at averyproducts.com.au/print



Code	Software Code	Colour	Size	Labels per Sheet	Sheets per Pack	Labels per Pack
Small Packs						
959126	L7168EV	White	199.6 x 143.5mm	2	20	40
959118	L7169EV	White	99.1 x 139mm	4	20	80
959127	L7163EV	White	99.1 x 38.1mm	14	20	280
959119	L7162EV	White	99.1 x 34mm	16	20	320
959128	L7159EV	White	64 x 33.8mm	24	20	480
959129	L7651EV	White	38.1 x 21.2mm	65	20	1300
Large Packs						
959120	L7167EV	White	199.6 x 289.1mm	1	100	100
959121	L7163EV	White	99.1 x 38.1mm	14	100	1400
959122	L7159EV	White	64 x 33.8mm	24	100	2400
959123	L7651EV	White	38.1 x 21.2mm	65	100	6500

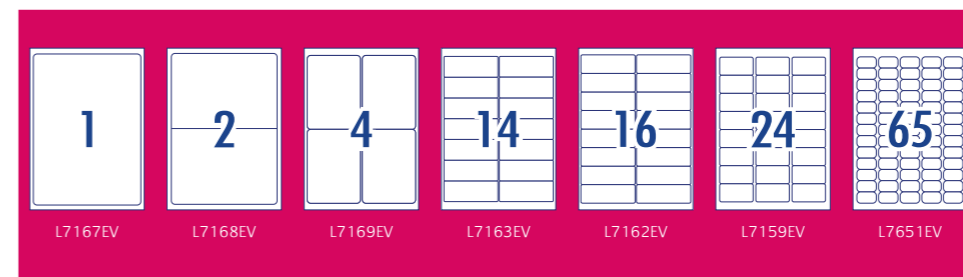



Did you know?

Creating an element of curiosity is an effective way of attracting potential customers to your item, whether that's to encourage a purchase or open a parcel.

Did you know?

Using multiple labels in shipping achieves more of the desired outcomes than just using one. Multiple labels increase brand love by 129% and 116% for parcel content quality.

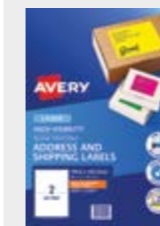

High Visibility Labels Laser

- Fluro coloured Shipping Labels make your parcels and items highly visible and enable instant recognition
- Jam-Free reliability for trouble free printing on Laser printers, saving time and minimising wastage
- Customise your labels with our free and easy-to-use template software; Avery Design and Print – available at averyproducts.com.au/print
- Ideal for marking documents and files that need special attention and for labelling products
- Available in a wide range of colours and sizes to suit your shipping needs
- FSC® certified labels made with paper from well managed forests and other controlled sources

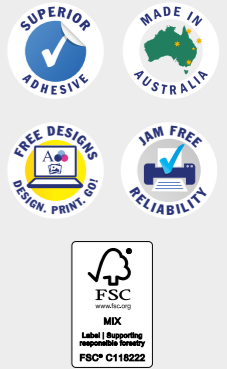

Code	Software Code	Colour	Size	Labels per Sheet	Sheets per Pack	Labels per Pack
959404	L7168FO	Fluro Orange	199.6 x 143.5mm	2	10	20
959405	L7168FY	Fluro Yellow	199.6 x 143.5mm	2	10	20
959408	L7168FG	Fluro Green	199.6 x 143.5mm	2	10	20
35998	L7167FP	Fluro Pink	199.6 x 289.1mm	1	25	25
35999	L7167FY	Fluro Yellow	199.6 x 289.1mm	1	25	25
36100	L7168FY	Fluro Yellow	199.6 x 143.5mm	2	25	50
36102	L7165FY	Fluro Yellow	99.1 x 67.7mm	8	25	200
36103	L7165FO	Fluro Orange	99.1 x 67.7mm	8	25	200
36104	L7165FG	Fluro Green	99.1 x 67.7mm	8	25	200
35937	L7163FG	Fluro Green	99.1 x 38.1mm	14	25	350
35947 BEST SELLER	L7163FY	Fluro Yellow	99.1 x 38.1mm	14	25	350
35957	L7163FP	Fluro Pink	99.1 x 38.1mm	14	25	350
35977	L7163FO	Fluro Orange	99.1 x 38.1mm	14	25	350
35932 BEST SELLER	L7162FG	Fluro Green	99.1 x 34mm	16	25	400
35942 BEST SELLER	L7162FY	Fluro Yellow	99.1 x 34mm	16	25	400
35952	L7162FP	Fluro Pink	99.1 x 34mm	16	25	400
35972	L7162FO	Fluro Orange	99.1 x 34mm	16	25	400



Did you know?

The use of a handwriting font can increase customer considerations by 30% and purchase intentions by 33%.



Crystal Clear Labels Laser

- Clear labels virtually disappear when applied to white and coloured surfaces for a printed on look
- Made from durable material, which is oil, dirt, splash and tear proof
- Customise your labels with our free and easy-to-use template software; Avery Design and Print – available at averyproducts.com.au/print
- Jam-Free reliability for trouble free printing on Laser printers, saving time and minimising wastage
- Ideal for sending elegant parcels, gifts and boxes



Code	Software Code	Colour	Size	Labels per Sheet	Sheets per Pack	Labels per Pack
958064	L7567	100% Transparent	199.6 x 289.1mm	1	10	10
959065	L7567	100% Transparent	199.6 x 289.1mm	1	25	25
959066	L7566	100% Transparent	199.6 x 143.5mm	2	25	50
958062	L7565	100% Transparent	99.1 x 67.7mm	8	10	80
959052	L7565	100% Transparent	99.1 x 67.7mm	8	25	200
958061	L7563	100% Transparent	99.1 x 38.1mm	14	10	140
959051	L7563	100% Transparent	99.1 x 38.1mm	14	25	350
958068	L7562	100% Transparent	99.1 x 34mm	16	10	160
959050	L7562	100% Transparent	99.1 x 34mm	16	25	400
958063	L7560	100% Transparent	63.5 x 38.1mm	21	10	210
959055	L7560	100% Transparent	63.5 x 38.1mm	21	25	525
959022	L7551	100% Transparent	38.1 x 21.2mm	65	25	1625



Frosted Clear Labels Inkjet

- Labels provide a contemporary frosted finish
- Compatible with Inkjet printers and smudge-free for a professional finish
- Customise your labels with our free and easy-to-use template software; Avery Design and Print – available at averyproducts.com.au/print
- Quick Peel® technology allows for quicker and easier detachment of labels from backing sheet
- Ideal for elegant parcels, boxes and gifts with black or dark surfaces



Code	Software Code	Colour	Size	Labels per Sheet	Sheets per Pack	Labels per Pack
936008	J8167	Frosted Clear	199.6 x 289.1mm	1	25	25
936002	J8566	Frosted Clear	199.6 x 143.5mm	2	25	50
936004	J8565	Frosted Clear	99.1 x 67.7mm	8	25	200
• Ideal for dark coloured or patterned envelopes, wedding invitations and corporate events						
958065	J8563	Frosted Clear	99.1 x 38.1mm	14	10	140
936005	J8563	Frosted Clear	99.1 x 38.1mm	14	25	350
958066	J8562	Frosted Clear	99.1 x 34mm	16	10	160
936006	J8562	Frosted Clear	99.1 x 34mm	16	25	400
958067	J8560	Frosted Clear	63.5 x 38.1mm	21	10	210
936007	J8560	Frosted Clear	63.5 x 38.1mm	21	25	525
936009	J8551	Frosted Clear	38.1 x 21.2mm	65	25	1625



Filing Labels Laser / Inkjet

- Trueblock labels feature an opaque silver backing which completely covers up existing labels or existing information on folders
- Labels are compatible with both inkjet and laser printers
- Customise your labels with our free and easy-to-use template software; Avery Design and Print – available at averyproducts.com.au/print
- Ideal for labelling small folders and files in the home or office
- FSC® certified labels made with paper from well managed forests and other controlled sources



Code	Software Code	Colour	Size	Labels per Sheet	Sheets per Pack	Labels per Pack
Lever Arch Label						
959035	L7171	White	200 x 60mm	4	25	100
Spine Label						
959036	L7172	White	100 x 30mm	18	25	450
959058	L7170	White	134 x 11mm	24	25	600

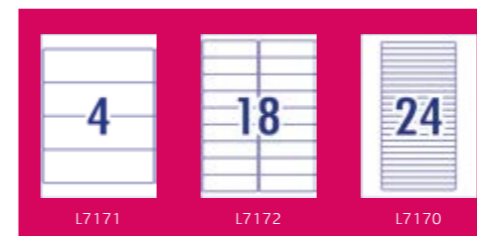

Reinforcement Ring Clear Labels

- Standard size clear vinyl reinforcement rings
- Suitable for both occasional and regular users
- Removable adhesive
- Available in easy to dispense units

Code	Colour	Size	Labels per Roll
934242	Clear	13mm diameter	250
934241	Clear	13mm diameter	500



Reinforcement Ring Donut Design Labels

- Durable, fun donut design reinforcement ring labels
- Suitable to repair and strengthen punched holes or use for crafting projects

Code	Colour	Size	Labels per Roll
5748	Multi Coloured Donut Design	14mm diameter	280



YOU
HAVE THE NEED
WE
HAVE THE LABEL

**CUSTOMISABLE
LABELS IN SMALLER
SHEET PACKS**

6 MATERIALS

- MATT
- GLOSS
- KRAFT BROWN
- CRYSTAL CLEAR
- TEXTURED LINEN
- MATT VINYL

8 SHAPES

**UNLIMITED
VERSATILITY**

- ✓ Available in small packs of up to 25 sheets
- ✓ Print only the amount of labels required from the convenience of your home or office printer
- ✓ Ideal for home, small businesses, organisation, or when you just need a label!
- ✓ Easily customise your labels with our free templates on averyproducts.com.au/print



Code	Software Code	Description	Size	Labels per Sheet	Sheets per Pack	Labels per Pack	Printer Compatibility	Adhesive Type
980001	L7105	Gloss White	60mm diameter	12	10	120	Laser / Inkjet	Permanent
980009	L7104REV	Matt White	60mm diameter	12	10	120	Laser / Inkjet	Removable
980002	L7106	Kraft Brown	60mm diameter	12	15	180	Laser / Inkjet	Permanent
980022	L7114	Crystal Clear	60mm diameter	12	10	120	Laser	Permanent
980081	L7589	Matt Vinyl	60mm diameter	12	10	120	Laser	Permanent
980080	L7588	Matt Vinyl	40mm diameter	24	10	240	Laser	Permanent
980062	L7304	Kraft Brown	40mm diameter	24	15	360	Laser / Inkjet	Permanent
980052	L7147	Gloss White	40mm diameter	24	10	240	Laser / Inkjet	Permanent
910007	L7129	Matt White	40mm diameter	24	8	192	Laser / Inkjet	Removable
959164	L6112C	Crystal Clear	40mm diameter	24	10	240	Laser	Permanent

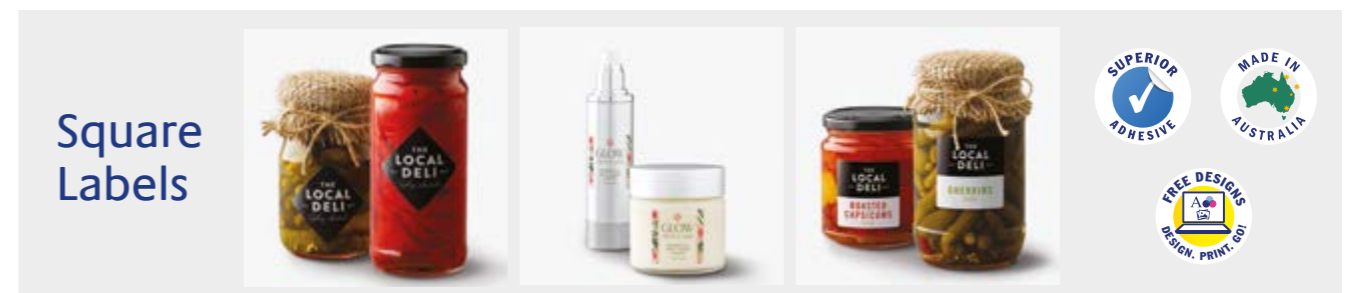

Code	Software Code	Description	Size	Labels per Sheet	Sheets per Pack	Labels per Pack	Printer Compatibility	Adhesive Type
980021	L7126	Crystal Clear	45 x 45mm	20	10	200	Laser	Permanent
980016	L7124	Gloss White	45 x 45mm	20	10	200	Laser / Inkjet	Permanent
980015	L7119	Gloss White	35 x 35mm	35	10	350	Laser / Inkjet	Permanent



Rectangle Labels



Code	Software Code	Description	Size	Labels per Sheet	Sheets per Pack	Labels per Pack	Printer Compatibility	Adhesive Type
959767	L7767	Gloss White*	199.6 x 289.1mm	1	25	25	Laser	Permanent
959770	L7167CL	Matt White*	199.6 x 289.1mm	1	20	20	Laser	Permanent
959150	L7167REV	Matt White	199.6 x 289.1mm	1	25	25	Laser / Inkjet	Removable
959768	L7768	Gloss White*	199.6 x 143.5mm	2	25	50	Laser	Permanent
959769	L7769	Gloss White*	99.1 x 139mm	4	25	100	Laser	Permanent
959151	L7169REV	Matt White	99.1 x 139mm	4	25	100	Laser / Inkjet	Removable
959765	L7765	Gloss White*	99.1 x 67.7mm	8	25	200	Laser	Permanent
959771	L7165CL	Matt White*	99.1 x 67.7mm	8	20	160	Laser	Permanent
959034	L7667	Matt White	133 x 29.6mm	9	25	225	Laser / Inkjet	Permanent
980011	L7108REV	Matt White	62 x 89mm	9	10	90	Laser / Inkjet	Removable
959033	L7666	Matt White	70 x 52mm	10	25	250	Laser / Inkjet	Permanent
980054	L7148	Matt Vinyl	96 x 51 mm	10	10	100	Laser	Permanent
980019	L7113	Crystal Clear	96 x 50.8 mm	10	10	100	Laser	Permanent
959023	L7671	Matt White	76.2 x 46.4mm	12	25	300	Laser / Inkjet	Permanent
980014	L7123	Gloss White	80 x 35mm	14	10	140	Laser / Inkjet	Permanent
959772	L7163CL	Matt White*	99.1 x 38.1mm	14	20	280	Laser	Permanent
959046	L7163REV	Matt White	99.1 x 38.1mm	14	25	350	Laser / Inkjet	Removable
959773	L7162CL	Matt White*	99.1 x 34mm	16	20	320	Laser	Permanent
959024	L7674	Matt White	145 x 17mm	16	25	400	Laser / Inkjet	Permanent
959048	L7162REV	Matt White	99.1 x 34mm	16	25	400	Laser / Inkjet	Removable
980013	L7109	Gloss White	62 x 42mm	18	10	180	Laser / Inkjet	Permanent
980010	L7107REV	Matt White	62 x 42mm	18	10	180	Laser / Inkjet	Removable
980017	L7110	Kraft Brown	62 x 42mm	18	15	270	Laser / Inkjet	Permanent
959774	L7160CL	Matt White*	63.5 x 38.1mm	21	20	420	Laser	Permanent
959032	L7665	Matt White	72 x 21.2mm	24	25	600	Laser / Inkjet	Permanent
959152	L7157REV	Matt White	64 x 24.3mm	33	25	825	Laser / Inkjet	Removable
910009	L7144	Matt White	38.1 x 21.2mm	65	8	520	Laser	Removable
959775	L7651CL	Matt White*	38.1 x 21.2mm	65	20	1300	Laser	Permanent
959049	L7651REV	Matt White	38.1 x 21.2mm	65	25	1625	Laser / Inkjet	Removable
959018	L7656	Matt White	46 x 11.1mm	84	25	2100	Laser / Inkjet	Permanent
959053	L7656	Matt White	46 x 11.1mm	84	25	2100	Laser / Inkjet	Removable

* These products are made from a thicker label material which provides an optimal base to print vibrant coloured labels

Did you know?

Labels that included a product signifier (like a bee on a pot of honey) made products much easier to find and made people look at the product for longer.

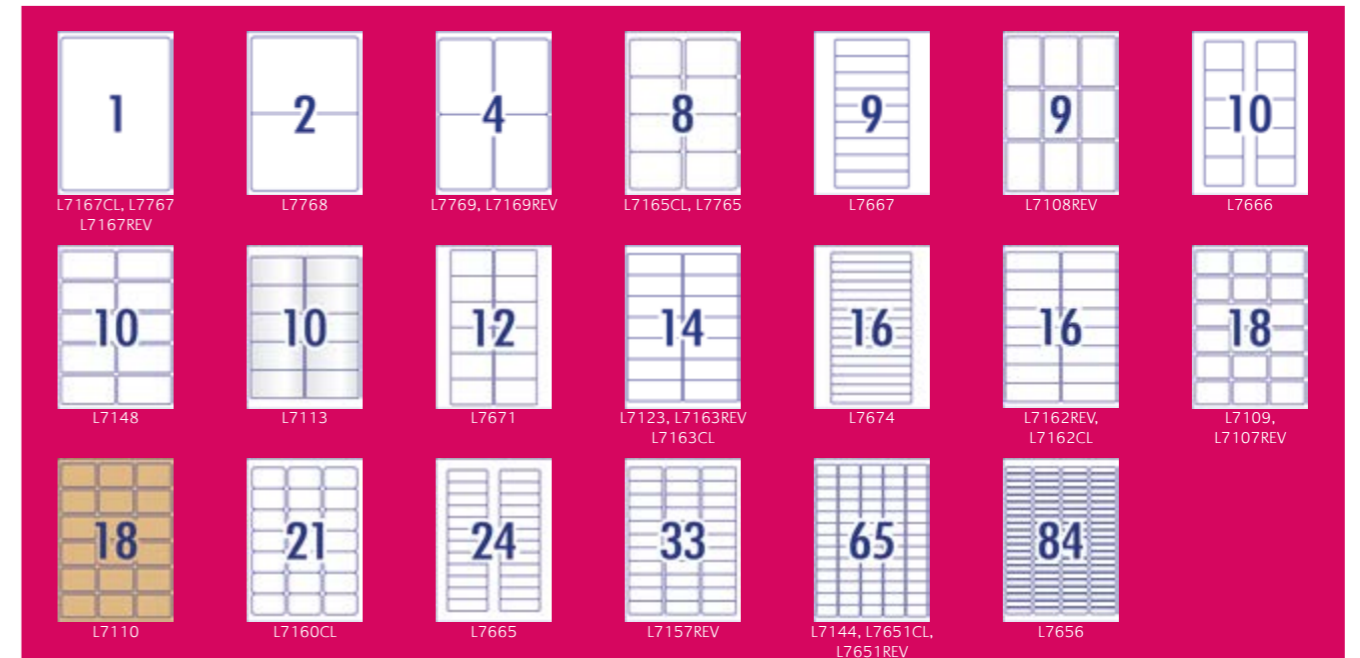

Oval Labels



Code	Software Code	Description	Size	Labels per Sheet	Sheets per Pack	Labels per Pack	Printer Compatibility	Adhesive Type
980012	L7127	Gloss White	84.7 x 50.8mm	8	10	80	Laser / Inkjet	Permanent
980000	L7102	Gloss White	63.5 x 42.3mm	18	10	180	Laser / Inkjet	Permanent
980008	L7101REV	Matt White	63.5 x 42.3mm	18	10	180	Laser / Inkjet	Removable
980018	L7103	Kraft Brown	63.5 x 42.3mm	18	15	270	Laser / Inkjet	Permanent
959165	L6024C	Crystal Clear	63.5 x 42.3mm	18	10	180	Laser	Permanent

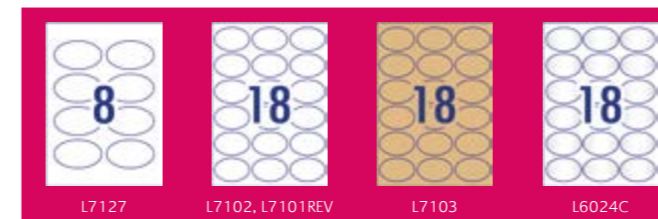

Wrap-Around Labels



Code	Software Code	Description	Size	Labels per Sheet	Sheets per Pack	Labels per Pack	Printer Compatibility	Adhesive Type
980053	L7146	Matt Vinyl	196 x 51mm	5	12	60	Laser	Permanent
980051	L7145	Kraft Brown	190 x 16mm	12	15	180	Laser / Inkjet	Permanent

Arch Labels



Code	Software Code	Description	Size	Labels per Sheet	Sheets per Pack	Labels per Pack	Printer Compatibility	Adhesive Type
982510	L7275	Linen Textured	89 x 120.7mm	4	5	20	Laser / Inkjet	Permanent
980003	L7118	Linen Textured	57.2 x 77mm	9	10	90	Laser / Inkjet	Permanent

CD Labels



Code	Software Code	Description	Size	Labels per Sheet	Sheets per Pack	Labels per Pack	Printer Compatibility	Adhesive Type
960101	L7676	Matt White	117mm	2	25	50	Laser / Inkjet	Permanent

Scallop Labels



Code	Software Code	Description	Size	Labels per Sheet	Sheets per Pack	Labels per Pack	Printer Compatibility	Adhesive Type
982518	L7283	Linen Textured	63mm	12	5	60	Laser / Inkjet	Permanent



A5 Coloured Labels Laser / Inkjet



- Premium pastel coloured labels are ideal for addressing, identification & organisation
- Compatible with Laser and Inkjet printers
- Customise your labels with our free and easy-to-use template software; Avery Design and Print – available at averyproducts.com.au/print
- Convenient A5 sheet pack for home use



Code	Software Code	Colour	Size	Labels per Sheet	Sheets per Pack	Labels per Pack
393000	L7264	Lavender Purple	94 x 32mm	8	10	80
393020	L7264	Mint Green	94 x 32mm	8	10	80
393010	L7264	Sky Blue	94 x 32mm	8	10	80
393200	L7261	Lavender Purple	63.5 x 24mm	16	10	160
393210	L7261	Sky Blue	63.5 x 24mm	16	10	160
393220	L7261	Mint Green	63.5 x 24mm	16	10	160



Did you know?

Choosing colour over black and white wins every time. Select colours that stand out, not only against your own packaging but against that of your competitors too.

White Dispenser Labels

- Multi-purpose identification labels
- Labels come in a handy dispenser pack for ease of use
- Great for often repeated tasks when you require easy access to labels
- Removable adhesive
- Available in a wide range of shapes

Code	Colour	Size	Labels per Roll
937200	White Circle	14mm diameter	1200
937202	White Circle	24mm diameter	550
937293	White Circle	32mm diameter	350
937303	White Rectangular	10 x 16mm	1500
937226	White Rectangular	101 x 24mm	160
937206	White Rectangular	24 x 10mm	1200
937209	White Rectangular	24 x 13mm	900
937305	White Rectangular	24 x 16mm	800
937215	White Rectangular	24 x 19mm	650
937219	White Rectangular	32 x 24mm	420
937304	White Rectangular	34 x 10mm	750
937210	White Rectangular	36 x 13mm	700
937217	White Rectangular	36 x 19mm	450
937220	White Rectangular	38 x 24mm	380
937212	White Rectangular	49 x 13mm	550
937221	White Rectangular	49 x 24mm	325
937222	White Rectangular	49 x 35mm	220
937223	White Rectangular	63 x 44mm	150
937218	White Rectangular	64 x 19mm	280
937224	White Rectangular	76 x 27mm	180
937306	White Rectangular	76 x 29mm	180
937225	White Rectangular	89 x 43mm	100
937289	White Square	19 x 19mm	900



Coloured Circle Dispenser Labels

- Multi-purpose identification labels
- Labels come in a handy dispenser pack for ease of use
- Great for often repeated tasks when you require easy access to labels
- Removable adhesive
- Available in a wide range of colours

Code	Colour	Size	Labels per Roll
937235	Red	14mm diameter	1050
937236	Blue	14mm diameter	1050
937237	Brown	14mm diameter	1050
937238	Green	14mm diameter	1050
937239	Yellow	14mm diameter	1050
937240	Orange	14mm diameter	1050
937241	Pink	14mm diameter	1050
937242	Black	14mm diameter	1050
937264	Purple	14mm diameter	1050
937369	NEW Rose Gold	14mm diameter	500
937274	Silver	14mm diameter	500
937275	Light Blue	14mm diameter	1050
937294	Fluoro Yellow	14mm diameter	700
937296	Fluoro Green	14mm diameter	700
937298	Fluoro Red	14mm diameter	700
937300	Fluoro Orange	14mm diameter	700
937370	NEW Fluoro Pink	14mm diameter	700
937243	Red	24mm diameter	500
937244	Blue	24mm diameter	500
937245	Brown	24mm diameter	500
937246	Green	24mm diameter	500
937247	Yellow	24mm diameter	500
937248	Orange	24mm diameter	500
937249	Pink	24mm diameter	500
937250	Black	24mm diameter	500
937371	NEW Rose Gold	24mm diameter	250
937271	Gold	24mm diameter	250
937272	Silver	24mm diameter	250
937276	Light Blue	24mm diameter	500
937295	Fluoro Yellow	24mm diameter	350
937297	Fluoro Green	24mm diameter	350
937299	Fluoro Red	24mm diameter	350
937301	Fluoro Orange	24mm diameter	350
937372	NEW Fluoro Pink	24mm diameter	350
937280	Kraft Brown	24mm diameter	400
937277	1/2 Blue & White	24mm diameter	300
937279	1/2 Pink & White	24mm diameter	300
937278	1/2 Mint & White	24mm diameter	300
937373	NEW Multi Coloured Rings	24mm diameter	300



Pre-printed Point of Sale Dispenser Labels

- Bright pre-printed point of sale labels for immediate recognition
- Labels come in a handy dispenser pack for ease of use
- Great for often repeated tasks when you require easy access to labels
- Removable adhesive
- Available in a range of pre-printed messages using fluoro colours



Code	Description	Colour		Size	Labels per Roll
937350	1/2 Price	Red & White Text	T	24mm diameter	300
937351	Sales Price	Red & White Text	T	24mm diameter	300
937352	Clearance	Red & White Text	T	24mm diameter	300
937353	Buy 1 Get 1 1/2 Price	Red & White Text	T	24mm diameter	300
937354	Price	Red & White Text	T	26 x 16mm	250
937356	Sale Was / Now	Red & White Text	T	60 x 40mm	100
937357	Clearance Was / Now	Red & White Text	T	60 x 40mm	100
937307	Sold printed Red	Red & White Text	T	19 x 64 mm	250
937309	Sale Was/Now	Red & White Text	T	44 x 63 mm	400
937253	Sold To	Red & White Text	T	64 x 19 mm	125
937355	50% Off	Red & White Text	T	24mm diameter	300
937260	Final Notice	Orange & Black Text	T	64 x 19 mm	125
937317	50% Off	Orange & Black Text	T	24mm diameter	500
937255	Sale Price	Orange & Black Text	T	30 x 24 mm	400

Pre-printed Dispenser Labels

- Bright pre-printed labels for immediate recognition
- Labels come in a handy dispenser pack for ease of use
- Great for often repeated tasks when you require easy access to labels
- Removable adhesive
- Available in a range of pre-printed messages using fluoro colours



Code	Description	Colour		Size	Labels per Roll
937261	Friendly Reminder	Green & Black Text	T	64 x 19 mm	125
937262	Any Reason	Yellow & Black Text	T	64 x 19 mm	125
937251	Urgent	Black & Orange Text	T	64 x 19 mm	125
937252	Fragile	Orange & Black Text	T	64 x 19 mm	125
937259	Urgent Action	Orange & Black Text	T	64 x 19 mm	125

Warehouse Labels

- Permanent adhesive ensures labels adhere to boxes and parcels
- The labels help to reduce the risk of damaged goods by providing a clear visual marking for packages that need to be handled with care
- Convenient dispenser box which easily dispenses labels



Code	Description	Colour		Size	Labels per Roll
932620	Accepted	Fluoro Green	T	75 x 48.8mm	1500
937900	Fragile	Fluoro Orange	T	75 x 130mm	1000*
932621	Quarantine	Fluoro Orange	T	75 x 74.2mm	1000
932623	Rejected	Fluoro Red	T	75 x 74.2mm	1000
932622	Hold	Fluoro Yellow	T	75 x 36.1mm	1000
932614	Mixed Goods	Fluoro Yellow	T	125 x 75mm	750
932602	Fragile	Fluoro Yellow	T	75 x 99.6mm	750
932618	Glass with Care	Fluoro Yellow	T	75 x 99.6mm	750
932615	Handle with Care	Fluoro Yellow	T	75 x 99.6mm	750
932604	Heavy	Fluoro Yellow	T	75 x 99.6mm	750
932619	Invoice Enclosed	Fluoro Yellow	T	75 x 99.6mm	750
932605	This Way Up	Fluoro Yellow	T	75 x 99.6mm	750
932617	Top Load Only	Fluoro Yellow	T	75 x 99.6mm	750
932616	Urgent	Fluoro Yellow	T	75 x 99.6mm	750
932603	Fragile	Fluoro Red	T	75 x 99.6mm	750

*Not packaged in dispenser



937900 – Fragile Fluoro Orange

Warehouse Dispenser State Labels

- These pre-printed State labels provide a clear visual ideal for identification on cartons and pallets
- Permanent adhesive ensures labels adhere to cartons and parcels
- Convenient dispenser box which easily dispenses labels



Code	Software Code	Colour		Size	Labels per Roll
932608	ACT	Printed Red	T	100 x 150.4mm	550
932610	NSW	Printed Blue	T	100 x 150.4mm	550
932612	NT	Printed Black	T	100 x 150.4mm	550
932613	QLD	Fluoro Red	T	100 x 150.4mm	500
932611	SA	Fluoro Orange	T	100 x 150.4mm	500
932606	Tasmania	Fluoro Yellow	T	100 x 150.4mm	500
932607	Victoria	Fluoro Green	T	100 x 150.4mm	500
932609	WA	Fluoro Pink	T	100 x 150.4mm	500



Dot Matrix Labels

- Dot matrix labels in a continuous fanfolds for Large mainframe printers or invoice processing
- 1 label wide

Code	Colour	Size	Across	Labels per Pack
939126	White	152 x 74mm	1 Wide	2000
939120	White	89 x 24mm	1 Wide	2500
939122	White	102 x 36mm	1 Wide	2500
939100	White	89 x 24mm	1 Wide	10000
939109	White	102 x 36mm	1 Wide	10000



Roll Address Labels

- Perfect for handwriting or identification purposes
- White, permanent labels
- Labels are on a roll for easy dispensing and frequent use
- Perforated between each label for easy separation



Code	Colour	Size	Labels per Roll
937106	White	89 x 24mm	250
937108	White	102 x 36mm	250
937103	White	63 x 36mm	500
937104	White	70 x 36mm	500
937105	White	78 x 48mm	500
937107	White	89 x 24mm	500
937109	White	102 x 36mm	500
937110	White	125 x 36mm	500
937111	White	102 x 49mm	500
937112	White with Black Border	78 x 48mm	500



Thermal Roll Labels

- Direct thermal labels
- Suit a wide range of machinery, including Zebra, Meto, Intermec, Datamax and TEC
- Ideal for creating product and inventory labels for quick and easy identification
- Available as a roll

Code	Colour	Size	Core Size	Labels per Roll
937113	White	102 x 36mm	38mm	500
937500	White	100 x 48mm	38mm	3000
937501	White	100 x 73mm	38mm	2000
937503	White	100 x 100mm	38mm	1500
937504	White	105 x 150mm	38mm	1000
932600	White	101 x 150mm	38mm	350
937601	White	101 x 150mm	38mm	500
937602	White	101 x 150mm	38mm	1000



Small Pack Labels - Clear Security Labels, Tamper Proof

- Designed to provide additional security on packaging, boxes and envelopes
- Round shaped crystal clear labels with star shaped perforation
- The star shape perforation will break to help you identify if packaging has been tampered with for added security and peace of mind
- Ideal for small businesses that want to securely tamper proof their boxes
- Convenient small size A6 pack, available in two sizes (30mm and 50mm)



Code	Colour	Size	Labels per Sheet	Sheets per Pack	Labels per Pack
39132 NEW	Clear	30mm Diameter	12	10	120
39133 NEW	Clear	50mm Diameter	4	10	40

Small Pack Labels – Coloured Shapes

- Multi-purpose stickers for everyday use
- Suitable for a range of identification projects in the home, school or office
- Permanent adhesive
- Available in resealable handipacks
- Available in a wide range of shapes and colours



Code	Colour	Size	Labels per Pack
932001	White Circle	8mm diameter	624
932291	Assorted Circle (Blue, Green, Yellow, Red)	8mm diameter	416
932002	White Circle	12mm diameter	270
932281	Fluoro Red Circle	12mm diameter	216
932282	Fluoro Green Circle	12mm diameter	216
932294	Assorted Circle (Green, Yellow, Red)	12mm diameter	162
932350	Gold Star	14mm diameter	90
932351	Silver Star	14mm diameter	90
932352	Assorted Small Stars (Green, Red, Silver, Gold, Blue)	14mm diameter	90
932361	Silver Heart	15mm diameter	70
932362	Gold Hearts	15mm diameter	70
932363	Red Hearts	15mm diameter	70
932292	Assorted Circle (Red, Yellow, Green, Blue)	16mm diameter	120
932289	Fluoro Yellow Circle	18mm diameter	120
932353	Gold Star	21mm diameter	36
932354	Silver Star	21mm diameter	36
932355	Gold Heart	23mm diameter	30
932356	Silver Heart	23mm diameter	30
932357	Red Heart	23mm diameter	30
932445	Number 00-99 White with black numbers	11 x 11mm	144
932443	Number 1-500 Black with white numbers	12 x 12mm	500
932448	Alphabet Gold Lettering A-Z	12 x 12mm	48
932297	Assorted (Red, Yellow, Green, Blue)	18 x 12mm	144
932073	Australian Flag	36 x 19mm	20





Small Pack Labels – Rectangle

- White multi-purpose stickers for everyday use
- Suitable for a range of identification projects in the home, school or office
- Permanent adhesive
- Available in resealable handpicks
- Available in a wide range of shapes and colours

Code	Colour	Size	Labels per Pack
932015	White	12 x 18mm	216
932018	White	14 x 38mm	105
932022	White	18 x 38mm	72
932024	White	24 x 38mm	63
932026	White	25 x 50mm	42
932016	White	32 x 10mm	132
932063	White	39 x 50mm	28
932009	White	50 x 6mm	140
932023	White	62 x 19mm	35
932029	White	76 x 19mm	30
932033	White	76 x 34mm	21
932036	White	80 x 54mm	14
932041	White	116 x 78mm	7
932384	White with Blue Border	75 x 34mm	18

Our Best Sellers



Code	Software Code	Description	Size	Labels per Sheet	Sheets per Pack	Labels per Pack
980040 BEST SELLER	L7427	Fabric Print & Divide Name Badge Labels Laser	88 x 52mm	10	15	150
959008 BEST SELLER	L7168	Shipping Labels with Trueblock® Laser	199.6 x 143.5mm	2	100	200
980001 BEST SELLER	L7105	Gloss White Round Labels Laser / Inkjet	60mm diameter	12	10	120
959004 BEST SELLER	L7163	Address Labels with Sure Feed® Laser	99.1 x 38.1mm	14	100	1400
959067 BEST SELLER	L7067	Heavy Duty Identification Labels Laser	199.6 x 289.1mm	1	25	25
937243 BEST SELLER		Red Circle Dispenser Labels	24mm diameter			500
44009Y BEST SELLER		TUBECLIP® File Fasteners 100 pack				



Avery General Use Labels Laser / Inkjet / Copier

- Ideal for mailing lists, account reminders and other frequent use applications
- Suited to medium speed, black and white laser printers and photocopiers
- FSC® certified labels made with paper from well-managed forests and other controlled sources
- Suitable for laser and inkjet printers



Code	Software Code	Colour	Size	Labels per Sheet	Sheets per Pack	Labels per Pack
938203	L7167GU	White	199.6 x 289.1mm	1	100	100
938206	L7169GU	White	99.1 x 139mm	4	100	400
938207	L7165GU	White	99.1 x 67.7mm	8	100	800
938208	L7164GU	White	63.5 x 72mm	12	100	1200
938209	L7163GU	White	99.1 x 38.1mm	14	100	1400
938202	L7162GU	White	99.1 x 34mm	16	100	1600
938210	L7161GU	White	63.5 x 46.6mm	18	100	1800
938201	L7159GU	White	64 x 33.8mm	24	100	2400
938211	L7158GU	White	64 x 26.7mm	30	100	3000
938200	L7157GU	White	64 x 24.3mm	33	100	3300
938212	L7156GU	White	58 x 17.8mm	45	100	4500



Heavy Duty Labels



Avery Heavy Duty Labels are engineered to withstand harsh environments.

Creating your own safety signage, asset management, pallet storage and chemical labels has never been easier with our Heavy Duty Labels. Use Avery Design & Print Online safety templates to create your own labels in an instant.

Material Specifications

Product	Material Type	Resistant to:						Tear-Proof	Permanent Adhesion	Triple Strength Adhesion	Tamper Evident	Temp Variations
		Saltwater	Chemicals	Water	UV	Oil	Dirt					
Heavy Duty Laser / Inkjet	Polyester			✓	✓	✓	✓	✓	✓			-20°C to +80°C
Heavy Duty Silver	Polyester			✓	✓	✓	✓	✓	✓			-40°C to +150°C
Ultra-Resistant	Polyethylene Film	✓	✓	✓	✓	✓	✓		✓			-40°C to +150°C
Removable	Polyester			✓	✓	✓	✓	✓				-20°C to +80°C
TripleBond™	Polyester			✓		✓	✓	✓		✓		-40°C to +100°C
NoPeel™	Acrylic			✓	✓	✓	✓			✓		-40°C to +100°C
Cable Markers	Polyester			✓	✓	✓	✓	✓	✓			-20°C to +80°C

Heavy Duty Laser Labels

- Engineered to take on tough applications where a standard label is not fit for purpose
- Durable labels are tear proof, water, dirt, oil and UV resistant with permanent adhesive
- Customise your Heavy Duty labels with our free and easy-to-use template software: Avery Design & Print – available at averyproducts.com.au/print
- Ideal for asset identification on machinery, equipment, organisation for storage and safety signs
- Unaffected by temperature variations -20°C to +80°C



Code	Software Code	Colour	Size	Labels per Sheet	Sheets per Pack	Labels per Pack
Small Packs						
959096	L7067	White	199.6 x 289.1mm	1	10	10
959162	L6112HD	White Round	40mm diameter	24	10	240
Large Packs						
959067	L7067	White	199.6 x 289.1mm	1	25	25
959068	L7068	White	199.6 x 143.5mm	2	25	50
959069	L7069	White	99.1 x 139mm	4	25	100
959063	L7063	White	99.1 x 38.1mm	14	25	350
959064	L7060	White	63.5 x 38.1mm	21	25	525
959070	L4778	White	45.7 x 21.2mm	48	25	1200

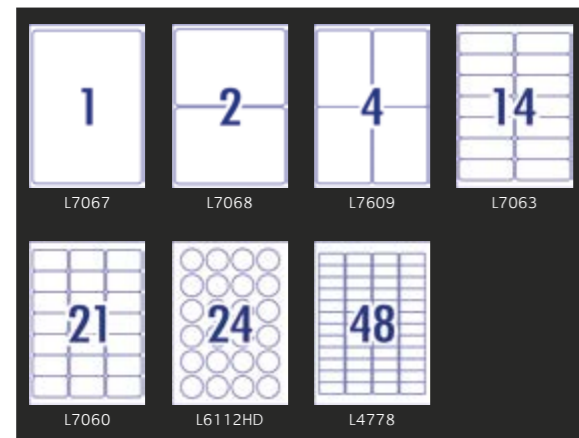

Did you know?

Safety First – Make staff and visitors aware of any dangers or hazards in the workplace and create Safety Signs compliant to the standard AS 1319 using Avery Design & Print Online software and templates.

Removable Heavy Duty Laser Labels

- Removable labels without leaving residue on substrate
- Tear proof, weather, UV, oil and dirt resistant
- Customise your Removable Labels with our free and easy-to-use template software: Avery Design & Print – available at averyproducts.com.au/print
- Ideal for creating temporary labelling of equipment, facilities and storage supplies, stock take and organising workshops
- Unaffected by temperature variations -20°C to +80°C



Code	Software Code	Colour	Size	Labels per Sheet	Sheets per Pack	Labels per Pack
959211	L4775REV	White	208x295 mm	1	20	20
959210	L4774REV	White	99.1x139 mm	4	20	80
959209	L4715REV	White	99.1x67.7mm	8	20	160
959208	L4776REV	White	99.1x42.3 mm	12	20	240
959207	L4773REV	White	63.5x33.9mm	24	20	480
959205	L4778REV	White	45.7x21.2mm	48	20	960
959206	L4716REV	White Round	30mm diameter	48	20	960

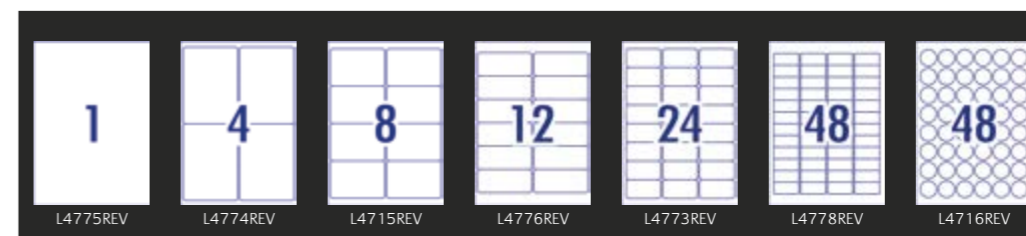

Silver Heavy Duty Laser Labels

- Engineered to take on tough applications where a standard label is not fit for purpose
- Durable labels are tear proof, water, dirt, oil and UV resistant with permanent adhesive
- Customise your Heavy Duty labels with our free and easy-to-use template software: Avery Design & Print – available at averyproducts.com.au/print
- Ideal for asset identification on computers, laptops, tablets, tools, labelling medications, samples and containers for use in refrigerators
- Unaffected by temperature variations -40°C to +150°C



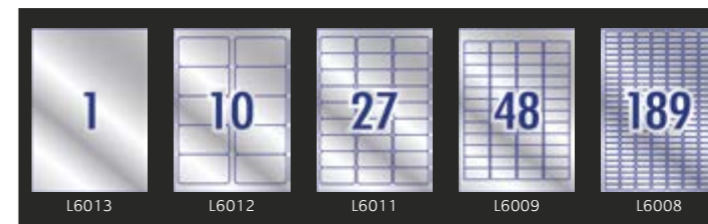

Code	Software Code	Colour	Size	Labels per Sheet	Sheets per Pack	Labels per Pack
959204	L6013	Silver	295 x 208mm	1	20	20
959203	L6012	Silver	96 x 50.8mm	10	20	200
959202	L6011	Silver	63.5 x 29.6mm	27	20	540
959201	L6009	Silver	45.7 x 21.2mm	48	20	960
959200	L6008	Silver	25.4 x 10mm	189	20	3780
959212	L6008	Silver	25.4 x 10mm	189	5	945



Heavy Duty Inkjet Labels

- No more blurry print on your Inkjet labels, our innovative material technology that is adapted to the special characteristics of Inkjet printers allowing for the typeface to be clean and pure
- Durable labels are tear proof, water, dirt, oil and UV resistant with permanent adhesive
- Customise your Heavy Duty labels with our free and easy-to-use template software: Avery Design & Print – available at averyproducts.com.au/print
- Ideal for asset identification on machinery, equipment, organisation for storage and safety signs
- Unaffected by temperature variations -20°C to +80°C

Code	Software Code	Colour	Size	Labels per Sheet	Sheets per Pack	Labels per Pack
936067	J4776	White	199.6 x 289.1mm	1	10	10
936068	J4774	White	99.1 x 139mm	4	10	40
936069	J4773	White	64 x 33.8mm	24	10	240



Ultra Heavy Duty Laser Labels

- Ultra Heavy Duty labels are Saltwater Resistant and *certified for GHS Chemical Labelling with permanent adhesive and engineered to take on harsh environments
- Customise your Heavy Duty labels with our free and easy-to-use template software: Avery Design & Print – available at averyproducts.com.au/print
- Ideal for chemical labelling, chemical decanting on-site, safety signs, arc flash, tanks, marine and outdoor applications
- Unaffected by temperature variations -40°C to +150°C





Code	Software Code	Colour	Size	Labels per Sheet	Sheets per Pack	Labels per Pack
959246	L7917	White	208 x 295mm	1	10	10
959245	L7916	White	210 x 148mm	2	10	20
959244	L7915	White	99.1 x 139mm	4	10	40
959243	L7914	White	99.1 x 67.7mm	8	10	80
959242	L7913	White	99.1 x 42.3mm	12	10	120
959241	L7912	White	63.5 x 33.9mm	24	10	240
959240	L7911	White	45.7 x 21.2mm	48	10	480

*Ultra Heavy Duty material is BS5609 Part 2 certified (label and adhesive durability for at least 90 days in seawater) and is approved for Chemical Hazard Labelling

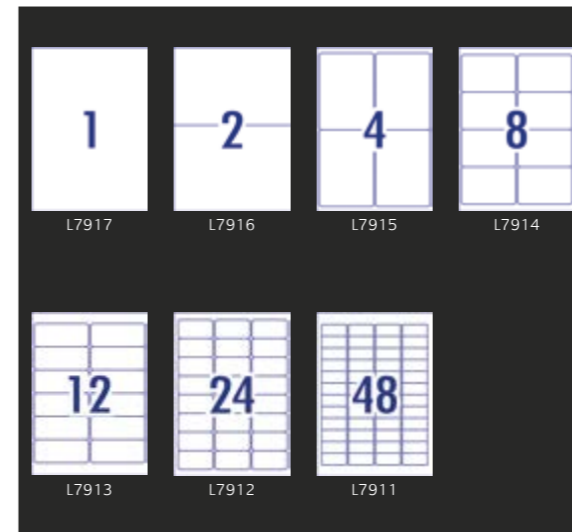

Did you know? A label is required for any substance, mixture or article classified as a hazardous chemical under the WHS Regulations. Avery labels help businesses comply with the code of practice.

Triple-Bond™ Identification Laser Labels

- TripleBond™ provides three times stronger adhesion than conventional paper labels
- Tough labels which are tear proof, water, dirt and oil resistant
- Customise your TripleBond™ labels with our free and easy-to-use template software: Avery Design & Print – available at averyproducts.com.au/print
- Ideal for indoor or outdoor applications; identifying scaffolding, racking, drums, containers and use in nurseries
- Unaffected by temperature variations -40°C to +100°C



Code	Software Code	Colour	Size	Labels per Sheet	Sheets per Pack	Labels per Pack
959220	L6140	White	45.7 x 25.4mm	40	10	400
959221	L6141	White	63.5 x 33.9mm	24	10	240

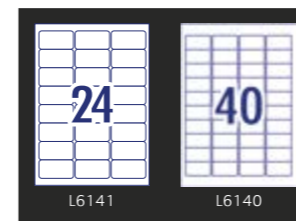



NoPeel™ Tamper Evident Security Laser Labels

- NoPeel™ tamper-evident labels provides visual evidence if removal has been attempted
- Durable labels are water, dirt, oil and UV resistant with permanent adhesive
- Customise your NoPeel™ labels with our free and easy-to-use template software; Avery Design & Print – available at averyproducts.com.au/print
- Ideal for labelling laptops, tablets, mobiles, lab equipment, machinery and office equipment
- Unaffected by temperature variations -40°C to +100°C



Code	Software Code	Colour	Size	Labels per Sheet	Sheets per Pack	Labels per Pack
959231	L6146	White	63.5 x 33.9mm	24	10	240
959230	L6145	White	45.7 x 25.4mm	40	10	400



Cable Marker Laser Labels

- Printable cable markers provide an easy solution for cable identification
- Fully customisable and heat-resistant makes these markers ideal for organising electronic cables and cords
- Customise your Cable Markers with our free and easy-to-use template software; Avery Design & Print – available at averyproducts.com.au/print
- Unaffected by temperature variations -20°C to +80°C



Code	Software Code	Colour	Size	Labels per Sheet	Sheets per Pack	Labels per Pack
910008	L7952	White	72 x 22 x 10mm	10	5	50

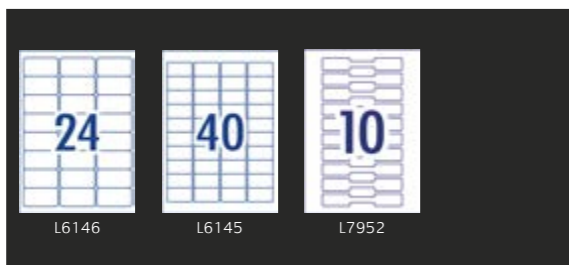

Thermal Roll Labels

- Direct thermal labels
- Suits a wide range of machinery, including Zebra, Meto, Intermec, Datamax and TEC
- Ideal for creating product and inventory labels for quick and easy identification



Code	Colour	Size	Core Size	Labels per Roll
937113	White	102 x 36mm	38mm	500
937500	White	100 x 48mm	38mm	3000
937501	White	100 x 73mm	38mm	2000
937503	White	100 x 100mm	38mm	1500
937504	White	105 x 150mm	38mm	1000
937601	White	101 x 150mm	38mm	500
937602	White	101 x 150mm	38mm	1000
932600	White	101 x 150mm	38mm	350



Self-Laminating Labels

- No laminating machine required
- Durable labels withstand tough conditions. Water resistant, UV resistant, tear resistant
- Permanent adhesive works on a variety of surfaces, including plastic, wood, metal, paper, ceramic and glass
- Built for tough environments such as Industrial, Warehouse, Logistics & Construction, these labels will stand the test of time and give you peace of mind



Code	Software Code	Colour	Size	Labels per Sheet	Sheets per Pack	Labels per Pack
959185	00750	White	127 x 190.5mm	1	5	5
959186	00751	White	88.9 x 114.3mm	2	5	10
959187	00752	White	58.7 x 84.1mm	4	5	20
959188	00753	White	26.2 x 88.9mm	10	5	50



Warehouse Labels

- Permanent adhesive ensures labels adhere to boxes and parcels
- The labels help to reduce the risk of damaged goods by providing a clear visual marking for packages that need to be handled with care
- Convenient dispenser box which easily dispenses labels



Code	Description	Colour		Size	Labels per Roll
932620	Accepted	Fluoro Green	T	75 x 48.8mm	1500
937900	Fragile	Fluoro Orange	T	75 x 130mm	1000*
932621	Quarantine	Fluoro Orange	T	75 x 74.2mm	1000
932623	Rejected	Fluoro Red	T	75 x 74.2mm	1000
932622	Hold	Fluoro Yellow	T	75 x 36.1mm	1000
932614	Mixed Goods	Fluoro Yellow	T	125 x 75mm	750
932602	Fragile	Fluoro Yellow	T	75 x 99.6mm	750
932618	Glass with Care	Fluoro Yellow	T	75 x 99.6mm	750
932615	Handle with Care	Fluoro Yellow	T	75 x 99.6mm	750
932604	Heavy	Fluoro Yellow	T	75 x 99.6mm	750
932619	Invoice Enclosed	Fluoro Yellow	T	75 x 99.6mm	750
932605	This Way Up	Fluoro Yellow	T	75 x 99.6mm	750
932617	Top Load Only	Fluoro Yellow	T	75 x 99.6mm	750
932616	Urgent	Fluoro Yellow	T	75 x 99.6mm	750
932603	Fragile	Fluoro Red	T	75 x 99.6mm	750

*Not packaged in dispenser



937900 – Fragile Fluoro Orange

Warehouse Dispenser State Labels

- These pre-printed State labels provide a clear visual ideal for identification on cartons and pallets
- Permanent adhesive ensures labels adhere to cartons and parcels
- Convenient dispenser box which easily dispenses labels



Code	Software Code	Colour		Size	Labels per Roll
932608	ACT	Printed Red	T	100 x 150.4mm	550
932610	NSW	Printed Blue	T	100 x 150.4mm	550
932612	NT	Printed Black	T	100 x 150.4mm	550
932613	QLD	Fluoro Red	T	100 x 150.4mm	500
932611	SA	Fluoro Orange	T	100 x 150.4mm	500
932606	Tasmania	Fluoro Yellow	T	100 x 150.4mm	500
932607	Victoria	Fluoro Green	T	100 x 150.4mm	500
932609	WA	Fluoro Pink	T	100 x 150.4mm	500



Antimicrobial Film

Eradicates the conditions bacteria* need to survive

A new transparent, self-adhesive film that can be used on high touch surfaces to help reduce the spread of some germs.

*E-Coli & S.aureus on the film according to ISO 22196 test





Avery Protect Antimicrobial Film
Eradicates the conditions bacteria need to survive

- Kills 99% of bacteria*
- Suitable for high touch surfaces such as doors, touchscreens, restaurant menus, lift buttons, desks and more
- Film can be routinely cleaned and is still effective
- Adhesive film can be applied to a variety of surfaces
- Available in removable or permanent adhesive

*E-Coli & S.aureus on the film according to ISO 22196 test

Code	Adhesive Type	Size	Labels per Sheet	Sheets per Pack	Labels per Pack
970100	Removable	199.6 x 289.1mm	1	10	10
970101	Removable	199.1 x 143.5mm	2	10	20
970102	Removable	99.1 x 139mm	4	10	40
970104	Permanent	199.6 x 143.5mm	2	10	20
970105	Permanent	99.1 x 139mm	4	10	40
970106	Permanent	Mixed Circles	63	10	630
970107	Permanent	Mixed Squares	68	10	400



Organise your home with Avery® Labels

Labels are a great way to stay organised and help make your life run a little more smoothly.



A5 Printable Organisation & Storage Labels Laser / Inkjet

- Premium linen material that is water-resistant
- Compatible with Laser and Inkjet printers
- Customise your labels with our free and easy-to-use template software; Avery Design and Print – available at averyproducts.com.au/print
- Print-to-the-edge for a full colour, professional looking finish
- Permanent adhesive sticks to multiple surfaces such as glass, plastic and paper



Code	Software Code	Colour	Size	Shape	Labels per Sheet	Sheets per pack	Labels per Pack
AE9011	AE9011	White (Blank)	60 x 40mm		8	4	32
AE9001	AE9001	White (Blank)	60 x 34mm		10	4	40
AE9004	AE9004	White (Blank)	60 x 34mm		10	4	40
AE9013 NEW	AE9013	White (Blank)	40mm diameter		12	4	48
AE9009	AE9009	White (Blank)	66 x 15mm		20	4	80



Durable Kitchen & Pantry Labels (Hand Writable)



- Hand writable labels for quick and easy identification, ideal for food container labels to identify the contents
- Labels are Dishwasher, Freezer and Microwave safe
- Made from durable material that is water resistant
- Removable adhesive leaves no residue so you can reuse containers*
- Convenient small size A6 pack for home use



Code	Description	Colour	Size	Labels per Sheet	Sheets per pack	Labels per Pack	
39020A NEW	Freezer Safe Labels	Assorted Fruity Coloured Designs		44.4 x 31.7mm	8	5	40
39021A NEW	Freezer Safe Labels	Assorted Red & Blue Gingham Pattern Designs		44.4 x 31.7mm	8	5	40
39021	Freezer Safe Labels	White with Green Design		44.4 x 31.7mm	8	5	40
39028	Freezer Safe Labels	White with Assorted Colours		45x 45mm	24	4	96
39027	Durable Labels	White with Assorted Colours		45mm diameter	24	4	96
39029	Durable Labels	White with Assorted Colours		70 x 40mm	4	4	16

*Note: adhesive may mark some surfaces or lift inks. Not recommended for thin or delicate papers.

Kraft Brown Kitchen & Pantry Labels (Hand Writable)



- Hand Writable labels for quick and easy identification
- Ideal for use on pantry containers
- Kraft brown in colour for a natural and earth aesthetic look
- Removable adhesive leaves no residue so you can reuse containers*
- Convenient A6 small size pack for home use



Code	Description	Colour	Size	Labels per Sheet	Sheets per pack	Labels per Pack	
39031	Multi Use Round	Kraft Brown		70mm Diameter	2	4	8
39013	Scallop Shape	Kraft Brown		57.1 x 28.6mm	4	6	24

*Note: adhesive may mark some surfaces or lift inks. Not recommended for thin or delicate papers.

Pre-Printed Kitchen & Pantry Labels



- These Pre-Printed Labels are the perfect solution to help keep your kitchen organised
- Convenient A6 small size pack for home use
- Stylish pre-printed black text on crystal clear labels, available in 2 popular kits:

Herbs & Spices Label Kit

- Pre-Printed Labels included: Allspice, Basil, Bay Leaves, Chilli, Chinese Five Spice, Chives, Cinnamon, Coriander, Cumin, Curry Powder, Garlic Powder, Italian Herbs, Mint, Nutmeg, Oregano, Paprika, Parsley, Pepper, Peppercorns, Rosemary, Salt, Sea Salt, Steak Seasoning, Thyme and Turmeric. Includes 5 blank labels which can be handwritten with a permanent marker.

Pantry Label Kit

- Pre-Printed Labels included: Arborio Rice, Breadcrumbs, Brown Rice, Brown Sugar, Caster Sugar, Cereal (x2), Cocoa, Coconut, Coffee, Cookies, Corn Flour, Couscous, Crackers, Icing Sugar, Muesli, Nuts, Oats, Pasta, Plain Flour, Quinoa, Rice, Salt, Self Raising Flour, Snacks, Spaghetti, Sugar and Tea. Includes 4 blank labels which can be handwritten with a permanent marker.

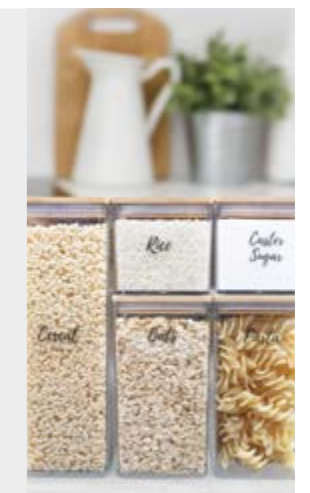

Code	Description	Colour	Size	Labels per Sheet	Sheets per pack	Labels per Pack	
39040 NEW	Herbs & Spices Label Kit	Clear with Black Text		44.4 x 25.4mm	10	3	30
39041 NEW	Pantry Label Kit	Clear with Black Text		70 x 40mm	4	8	32

Chalkboard Organisation Labels (Hand Writable)

- Hand writable labels for quick and convenient identification
- Ideal for containers with ever changing contents
- Erasable surface works best with chalk or liquid chalk
- Removable adhesive sticks to multiple surfaces and removes cleanly*
- Convenient small size A6 pack for home use

Code	Description	Colour	Size	Labels per Sheet	Sheets per Pack	Labels per Pack
39103	Chalkboard Rectangle	Black	132 x 88mm	1	4	4
39102	Chalkboard Rectangle	Black	95 x 45mm	3	4	12
39100	Chalkboard Round	Black	70mm Diameter	8	4	32
39101	Chalkboard Scallop	Black	95 x 45mm	12	4	48

*Note: adhesive may mark some surfaces or lift inks. Not recommended for thin or delicate papers.

Organisation & Storage Labels (Hand Writable)

- Hand writable labels for quick and easy identification
- Ideal for use on home storage containers or boxes
- Made from durable material that is water resistant
- Removable adhesive sticks to multiple surfaces and removes cleanly*

Code	Description	Colour	Size	Labels per Sheet	Sheets per Pack	Labels per Pack
39015A NEW	Durable Labels	White with Assorted Pastel Designs	44.4 x 25.4mm	10	5	50
39017A NEW	Durable Labels	White with Assorted Black & White Designs	44.4 x 31.7mm	10	5	50
39017	Durable Labels	White with Brown	44.4 x 25.4mm	10	5	50
39030	Durable Labels	White with Assorted Colours	91 x 68mm	2	4	8

*Note: adhesive may mark some surfaces or lift inks. Not recommended for thin or delicate papers.

NEW Organisation & Storage Labels (Re-Writable)

- Labels are made from dry erase material, so you can write, erase and write again
- Ideal for use on storage bins, boxes, glass and more
- Removable adhesive sticks to multiple surfaces and removes cleanly*
- Use with dry erase whiteboard markers
- Convenient small size A6 pack for home use

Code	Description	Colour	Size	Labels per Sheet	Sheets per Pack	Labels per Pack
39019A	Re-writable Rectangle	White with Assorted Palm Design	88.9 x 31.7mm	4	4	16

*Note: adhesive may mark some surfaces or lift inks. Not recommended for thin or delicate papers.

Cord Tag Labels (Hand Writable)

- Hand writable labels for quick and convenient identification
- Ideal for identifying and organising your electrical and other cords
- Made from durable material that is resistant to water, hot and cold temperatures
- Convenient small size A6 pack for home use

Code	Description	Colour	Size	Labels per Sheet	Sheets per Pack	Labels per Pack
39032	White Rectangle	White	40 x 60mm	24	4	96

Garage & Outdoor Labels (Hand Writable)

- Keep your garage and outdoor space just as organised as your home and office
- Durable water resistant material
- The Durable & Heavy Duty Garage & Outdoor Labels come with a removable adhesive, sticks to multiple surfaces and removes cleanly if required* (applies to product code 39014, 39042 and 39043)
- The self laminating label (product code: 39033) comes with a clear film, that protects your writing and helps keep the label surface clean and protected. The surface of the label can be cleaned with a damp cloth or a household cleaner
- Convenient small size A6 pack for home use

Code	Description	Colour	Size	Labels per Sheet	Sheets per Pack	Labels per Pack
39042 NEW	Heavy Duty Small Rectangle	White	19 x 44.5mm	12	5	60
39043 NEW	Heavy Duty Large Rectangle	White	31.75 x 89mm	4	5	20
39033	Self Laminating Rectangle	White with Grey Border	86 x 17mm	6	4	24

*Note: adhesive may mark some surfaces or lift inks. Not recommended for thin or delicate papers.

Adhesive Pocket (Hand Writable)

- Insert pocket allows for quick change of card whenever needed
- Adhesive pockets stick to a variety of surfaces
- Writable cardstock for quick and easy identification
- Convenient small size A6 pack for home use

Code	Description	Colour	Size	Labels per Sheet	Sheets per Pack	Labels per Pack
39024	Adhesive Pocket & Inserts	Clear with Green details	Insert 50.8 x 88.9mm Pocket 58.4 x 95.2mm	2	3	6

Printable Magnet Sheets - Inkjet

- Create your own fridge magnets
- Compatible with Inkjet printers
- Customise your magnets with our free and easy-to-use template software; Avery Design and Print- available at averyproducts.com.au/print
- A4 sheets can be cut into shapes or different sizes
- Perfect for fridges or magnetic notice boards
- Ideal for printed photo fridge magnets, invitations, signs and lots more

Code	Software Code	Colour	Size	Quantity per Sheet	Sheets per Pack	Quantity per Pack
71021	C9415	White	210 x 297mm	1	3	3
79023	C9415	White	210 x 297mm	1	30	30

Did you know?

Keep your kids' clothing out of the lost-and-found with our No-Iron Clothing Labels - all you need to do is write, peel and stick! It's that easy.

No Iron Clothing Labels (Hand Writable)

- Just write, peel and stick – no iron required
- Perfect for labelling jackets, t-shirts, hats, backpacks and more
- Labels withstand multiple washing machine and dryer cycles
- Permanent adhesive – Work best with permanent markers
- Allow label to set for 24 hours prior to washing
- Convenient small size A6 pack for home use

Code	Description	Colour	Size	Labels per Sheet	Sheets per Pack	Labels per Pack
40700	Assorted Shapes Permanent	White	Assorted	15	3	45
40720	Rectangle Permanent	White	45 x 13mm	18	3	54

T Shirt Transfer – Inkjet

- Design your own t-shirts using photos, logos, text and more
- Available in both clear and white transfer options for use on light and dark coloured t-shirts
- Customise your transfers with our free and easy-to-use template software; Avery Design and Print – available at averyproducts.com.au/print
- Ideal for when you need a personalised t-shirt such as events, gifts and more
- Easy to use with instructions in pack

Code	Software Code	Description	Size	Sheets per Pack
70580	C9414	White T Shirt Transfer	297 x 210mm (A4)	5
79009	C9414	Dark Colour T Shirt Transfer	297 x 210mm (A4)	5



NEW Printable Fabric Sheets - Inkjet

- Personalise and print on the cotton fabric, iron-on or sew-on to customise your item
- Ideal for tote bags, pillows, aprons, quilts, photo album covers, caps and more
- Heatseal backing bonds to fabric, cardboard, wood, and other porous surfaces
- Easy to use with instructions in pack

Code	Software Code	Description	Size	Sheets per Pack
70590	L9415	Printable Fabric Sheets	297 x 210mm (A4)	5

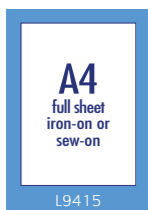

Durable Labels (Hand Writable)

- Dishwasher and microwave safe
- Labels stick to plastic, wood, metal, rubber, paper, ceramic and glass
- Labels are guaranteed to cover over anything underneath
- Work best with permanent markers

Code	Description	Colour	Size	Labels per Sheet	Sheets per Pack	Labels per Pack
41413	Permanent	Assorted (Blue & Green Border)	89 x 32mm	4	5	20
41440	Permanent	Assorted (Blue, Red & Green Border)	89 x 16mm	7	5	35
41441	Permanent	Assorted (Blue, Red & Green Border)	44 x 19mm	12	5	60

Durable Kids Labels (Hand Writable)

- Label all your back to school needs with labels that will last
- Perfect for pen/pencils, rulers, books, water bottles, lunch boxes and so much more!
- Durable Water-resistant label with strong adhesive
- Dishwasher and Microwave Safe
- Works best with permanent markers
- Label adheres to plastic, wood, metal, rubber, paper, ceramic and glass
- 42 Labels / 3 Sheets
- Assorted shapes and sizes

Code	Description	Pack Contents
41418	Hello it's me Durable School Label Multipack PK3	Each sheet contains: <ul style="list-style-type: none"> • 2 x large name stickers: 25 x 50mm • 4 x medium name stickers: 15 x 45mm • 2 x square name stickers: 35 x 35mm • 6 x Mini Pen stickers: 42 x 7mm
41419	Love Dream Shine Durable School Label Multipack PK3	Each sheet contains: <ul style="list-style-type: none"> • 2 x large name stickers: 25 x 50mm • 4 x medium name stickers: 15 x 45mm • 2 x square name stickers: 35 x 35mm • 6 x Mini Pen stickers: 42 x 7mm

NEW Kids School Labels (Hand Writable)

- Protects your writing and helps keep the label surface clean & protected.
- Perfect for labelling almost any item including lunch boxes, bottles and sporting goods as well as day care, school and camping gear
- Help to identify often misplaced pens and pencils. Ideal size for smaller stationery items or any products (41503 & 41504)
- Just write, Seal and Stick!
- Assorted shapes and sizes

Code	Description	Colour	Size	Labels per Sheet	Sheets per Pack	Labels per Pack
41500	Kids Self Laminating Labels	Pastel	Assorted	12	2	24
41501	Kids Self Laminating Labels	Neon	Assorted	12	2	24
41502	Kids Ultra Resistant Labels	Assorted	44 x 64mm	4	4	16
41503	Kids Pencil Labels	Pink/Purple	52 x 12mm	15	2	30
41504	Kids Pencil Labels	Green/Blue	52 x 12mm	15	2	30



Education

Inspiring and rewarding kids at home & school

Bring a smile to their faces with a range of bright, fun merit stickers, certificates and merit ribbons!

NEW Merit Dispenser Stickers

- Stickers in a handy dispenser pack for ease of use
- Perfect for teachers marking bulk homework and other often repeated tasks
- Encourages and praises good behaviour and is effective for teachers in classroom management
- Bright, Colourful designs that kids will aspire to collect
- FSC certified stickers made with paper from well-managed forests and other controlled sources



Code	Description	Size	Labels per Pack	Designs per Pack
698010	Animals	24mm	400	10
698011	Smiley Faces	24mm	400	10
698012	Rainbow	24mm	400	10
698013	Pastel Hearts	24mm	400	10



Merit Mini-Dispenser Stickers

- Stickers in a handy mini dispenser pack for ease of use
- Perfect for teachers or parents wanting to reward good behaviour
- Bright, colourful designs that kids will aspire to collect

Code	Description	Size	Labels per Pack	Designs per Pack
69602	Star Face Metallic	30mm	50	6
69606	Wow Stars Metallic	45mm	50	6



Merit Stickers Small Packs

- 36-102 stickers in a pack depending on design
- Perfect for teachers or parents wanting to reward good behaviour
- Bright, colourful designs that kids will aspire to collect

Code	Description	Size	Labels per Pack	Designs per Pack
698001	NEW Comic	Assorted	80	20
698002	NEW Messaging	Assorted	68	17
698003	NEW Cosmos	Assorted	36	9
698004	NEW Praise	Assorted	52	13
698005	NEW Owl	Assorted	40	10
69601	Aussie Animals	30mm	96	6
69604	Farm Animals	30mm	96	6
69605	Aussie Art	30mm	96	6
69607	Brights	30mm	96	6
69614	Paint Splats	30mm	96	6
69621	Cartoon Band	30mm	102	6
69634	Happy Birthday	30mm	102	1
69639	Dazzling Stars	30mm	102	6



Merit Stickers Large Packs

- 200-800 Stickers in a pack depending on design
- Perfect for teachers or parents wanting to reward good behaviour
- Bright, colourful designs that kids will aspire to collect

Code	Description	Size	Labels per Pack	Designs per Pack
698006 NEW	Smiley Faces	22mm	300	5
698007 NEW	Captions 1	22mm	300	5
698008 NEW	Captions 2	22mm	300	5
698009 NEW	Captions 3	22mm	300	5
69618	Mini Smiley Face	13mm	800	5
69620	Mini Assorted	13mm	800	5
69622	Mini Brights	14mm	800	5
69623	Multi Captions	22mm	200	5



NEW Printable Classroom Labels

- Perfect for teachers and school classrooms / kindergartens
- Printable labels for tubs, books and an assortment of labelling
- Compatible with Laser and Inkjet printers
- Removable
- Customise your labels with our free and easy-to-use templates



Code	Software Code	Colour	Size	Labels per Sheet	Sheets per Pack	Labels per Pack
983000	L7167	White	<input type="checkbox"/> 199.6 x 289.1mm	1	20	20
983001	L7169	White	<input type="checkbox"/> 99.1 x 139mm	4	20	80
983002	L7165	White	<input type="checkbox"/> 99.1 x 67.7mm	8	20	160



Sticker Activity Books

- Sticker Activity Books are ideal for early learners who are developing fine motor skills, shape and colour recognition
- Each book contains over 400 stickers to complete the step by step activities
- Suitable for children from three years of age onwards
- Produced using FSC® certified paper from well-managed forests and other controlled sources



Code	Description	Content	Dimensions
620002	Avery Green Sticker Activity Book, Ages 3+	1 Book	210 x 298 mm
620003	Avery Red Sticker Activity Book, Ages 4+	1 Book	210 x 298 mm
620004	Avery Blue Sticker Activity Book, Ages 5+	1 Book	210 x 298 mm
620005	Avery Yellow Sticker Activity Book, Ages 6+	1 Book	210 x 298 mm

Lateral Filing



Evolve your filing into a highly efficient Colour-coded System!

Avery Lateral Filing products provide a customisable colour-coded solution for your home or office. The comprehensive range includes Cabinets, Files, Fasteners, pre-printed Colour-coding labels & customisable labels using Avery Filepro Software.

Lateral Filing Folder Dimensions and Weights Guide

DIMENSIONS

A4	332 x 242mm
Foolscap	367 x 242mm
Notes	355 x 235mm
Legal	388 x 242mm

WEIGHTS

Heavy Weight	240-250gsm
Extra Heavyweight	300-325gsm
Formakote Heavyweight	300-325gsm
Super Weight	370-380gsm



Shelf Lateral Files

- Files are available in a variety of sizes and board type to suit your everyday filing needs
- Use in an existing shelf unit, cabinet or mobile shelving unit
- Customise Lateral Filing labels with Avery FilePro® software and Filing Labels (959095)
- Alternatively, use with Avery manual colour coding labels
- 35mm Expansion for everyday filing



Code	Size	Colour	Board Type	Box
42713	A4	Buff	Heavyweight	100
46704	A4	Buff	Extra Heavyweight	100
46703	A4	White	Extra Heavyweight	100
46501	Foolscap	White	Extra Heavyweight	15
46503	Foolscap	White	Extra Heavyweight	100
46504	Foolscap	Buff	Extra Heavyweight	100
42513	Foolscap	Buff	Heavyweight	100
45413	Foolscap	Yellow	Extra Heavyweight	100
45113	Foolscap	Red	Extra Heavyweight	100
45213	Foolscap	Blue	Extra Heavyweight	100
45313	Foolscap	Green	Extra Heavyweight	100
42538	Legal	Buff	Extra Heavyweight	100
42520	Legal	White	Extra Heavyweight	100
46720	355 x 235mm	White / Brown	Formakote Heavyweight	50



Twin Tab Shelf Lateral File

- Dual purpose file with side tab as well as top tab. Versatile as it can be used in either a drawer cabinet or on a shelf unit
- Customise Lateral Filing labels with Avery FilePro® software and Filing Labels (959095)
- Alternatively, use with Avery manual colour coding labels
- 35mm Expansion for everyday filing



Code	Size	Colour	Board Type	Box
46555	Foolscap	White	Extra Heavyweight	100



Shelf Lateral File with Coloured Tear-Proof Ends

- White shelf lateral files with a coloured plastic tear-proof tab
- Add a TUBECLIP® or Permclip® File Fastener which allows papers to be secured and easily accessed
- Customise Lateral Filing labels with Avery FilePro® software and Filing Labels (959095)
- Alternatively, use with Avery manual colour coding labels
- 35mm Expansion for everyday filing



Code	Size	Colour	Board Type	Box
42421	Foolscap	White with White Tab <input type="checkbox"/>	Extra Heavyweight	100
42430	Foolscap	White with Pink Tab <input type="checkbox"/>	Extra Heavyweight	100
42431	Foolscap	White with Red Tab <input type="checkbox"/>	Extra Heavyweight	100
42433	Foolscap	White with Orange Tab <input type="checkbox"/>	Extra Heavyweight	100
42434	Foolscap	White with Light Green Tab <input type="checkbox"/>	Extra Heavyweight	100
42435	Foolscap	White with Dark Green Tab <input type="checkbox"/>	Extra Heavyweight	100
42436	Foolscap	White with Light Blue Tab <input type="checkbox"/>	Extra Heavyweight	100
42437	Foolscap	White with Purple Tab <input type="checkbox"/>	Extra Heavyweight	100
42440	Foolscap	White with Yellow Tab <input type="checkbox"/>	Extra Heavyweight	100
42521	Legal	White with White Tab <input type="checkbox"/>	Extra Heavyweight	100
42531	Legal	White with Red Tab <input type="checkbox"/>	Extra Heavyweight	100
42533	Legal	White with Orange Tab <input type="checkbox"/>	Extra Heavyweight	100
42534	Legal	White with Light Green Tab <input type="checkbox"/>	Extra Heavyweight	100
42535	Legal	White with Dark Green Tab <input type="checkbox"/>	Extra Heavyweight	100
42536	Legal	White with Light Blue Tab <input type="checkbox"/>	Extra Heavyweight	100
42537	Legal	White with Purple Tab <input type="checkbox"/>	Extra Heavyweight	100
42540	Legal	White with Yellow Tab <input type="checkbox"/>	Extra Heavyweight	100



Shelf Lateral File with Fastener

- Each file is fitted with either a TUBECLIP®, Permclip or Spring Transfer File Fastener which allows papers to be secured and easily accessed whenever required
- Customise Lateral Filing labels with Avery FilePro® software and Filing Labels (959095)
- Alternatively, use with Avery manual colour coding labels



Code	Fastener	Colour	Board Type	Box
46510 BEST SELLER	TUBECLIP®	White <input type="checkbox"/>	Extra Heavyweight	100
46719	TUBECLIP®	White / Brown <input type="checkbox"/>	Formakote Heavyweight	50
46511	Permclip	White <input type="checkbox"/>	Extra Heavyweight	100
46512	Spiral Spring Transfer (40mm expansion)	White <input type="checkbox"/>	Super Heavyweight	50



Shelf Lateral Document Wallet

- Manufactured from extra heavy weight manilla board for durability
- Ideal for storing documents that cannot be hole-punched such as annual reports, legal and financial documents
- Customise Lateral Filing labels with Avery FilePro® software and Filing Labels (959095)
- Alternatively, use with Avery manual colour coding labels
- 40mm Expansion



Code	Size	Colour	Board Type	Box
43950	Foolscap	Buff <input type="checkbox"/>	Extra Heavyweight	20
43955	Foolscap	White <input type="checkbox"/>	Extra Heavyweight	20



Shelf Lateral Concertina Pocket

- Manufactured from quality manilla board for durability
- Ideal for storing documents that cannot be hole-punched such as annual reports, legal and financial documents
- Concertina pocket style with 100 mm expansion stores heavier document easily
- Available in legal, foolscap or 355 x 235mm size to suit your preferences
- Customise Lateral Filing labels with Avery FilePro® software and Filing Labels (959095)



Code	Size	Colour	Board Type	Box
43957	Legal	White <input type="checkbox"/>	Extra Heavyweight	25
43958 BEST SELLER	Foolscap	White <input type="checkbox"/>	Extra Heavyweight	25
46718	355 x 235 mm	White <input type="checkbox"/>	Extra Heavyweight	25



Shelf Lateral Document Pocket

- Ideal for storage of loose papers
- Extra heavyweight for durability
- Customise Lateral Filing labels with Avery FilePro® software and Filing Labels (959095)
- Alternatively, use with Avery manual colour coding labels



Code	Size	Colour	Board Type	Box
43949	Foolscap	White <input type="checkbox"/>	Extra Heavyweight	20



Shelf Lateral Notes Files Size 355 x 235mm

- Pre-Printed blue panel on the cover to enable related information to be noted directly onto the file. Manufactured from heavy weight archival board
- Reinforced side tabs for easy colour code labelling
- Customise Lateral Filing labels with Avery FilePro® software and Filing Labels (959095)
- Alternatively, use with Avery manual colour coding labels

Code	Size	Expansion	Board Type	Box
46710	Standard Lateral File	35mm	Extra Heavyweight	100
46711 BEST SELLER	Standard File with TUBECLIP®	35mm	Extra Heavyweight	100
46712	Standard File with Spiral Spring	40mm	Superweight	50
46713	Standard file with Left Hand Pocket	35mm	Extra Heavyweight	20
46714	Twin Tab	35mm	Extra Heavyweight	100
46716	Twin Tab Pocket	40mm	Extra Heavyweight	20
46715	Lateral File Pocket	40mm	Extra Heavyweight	20
46717	Lateral File Doc Wallet	40mm	Extra Heavyweight	20



Lateral Filing Binders

- The sturdy construction is ideal for frequent referencing
- Heavy Duty D Ring with 52mm Expansion
- Customise Lateral Filing labels with Avery FilePro® software and Filing Labels (959095)
- Alternatively, use with Avery manual colour coding labels



Code	Size	Colour	Board Type	Box
46513	367 x 242 mm	White/Brown <input type="checkbox"/> <input checked="" type="checkbox"/>	Heavyweight	15
46514	367 x 242 mm	White <input type="checkbox"/>	Superweight	10

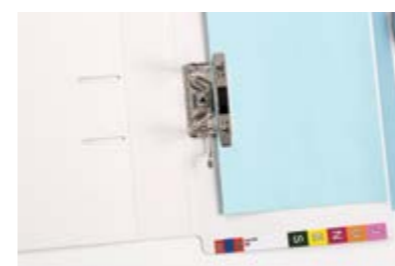

Lateral Filing Lever Arch Folder

- The sturdy construction is ideal for frequent referencing
- Heavy Duty with 70mm Expansion
- Customise Lateral Filing labels with Avery FilePro® software and Filing Labels (959095)
- Alternatively, use with Avery manual colour coding labels



Code	Size	Colour	Board Type	Box
46515 BEST SELLER	Lever Arch 70mm expansion	White <input type="checkbox"/>	Superweight	5



Fullvue Lateral Files

- A unique flap on the front edge absolute visibility of the file tab and title label
- Available in 2 spine widths – 30 mm and 50 mm
- Great for heavy weight documents requiring tab and title visibility
- Customise Lateral Filing labels with Avery FilePro® software and Filing Labels (959095)
- Alternatively, use with Avery manual colour coding labels



Code	Size	Colour	Board Type	Box
165707	Foolscap with 50mm gusset	White / White Spine <input type="checkbox"/> <input type="checkbox"/>	Heavyweight	100
165720	Foolscap with 30mm gusset	White / White Spine <input type="checkbox"/> <input type="checkbox"/>	Heavyweight	100
165715DGR	Foolscap with 30mm gusset	White / Dark Green Spine <input type="checkbox"/> <input checked="" type="checkbox"/>	Heavyweight	100
165715LBL	Foolscap with 30mm gusset	White / Light Blue Spine <input type="checkbox"/> <input checked="" type="checkbox"/>	Heavyweight	100
165715ORA	Foolscap with 30mm gusset	White / Orange Spine <input type="checkbox"/> <input checked="" type="checkbox"/>	Heavyweight	100
165715PUR	Foolscap with 30mm gusset	White / Purple Spine <input type="checkbox"/> <input checked="" type="checkbox"/>	Heavyweight	100
165715RED	Foolscap with 30mm gusset	White / Red Tab Spine <input type="checkbox"/> <input checked="" type="checkbox"/>	Heavyweight	100
165715YEL	Foolscap with 30mm gusset	White / Yellow Spine <input type="checkbox"/> <input checked="" type="checkbox"/>	Heavyweight	100



Desktop Filing Starter Pack – Code No. 40466

Starter Pack contains:

- 1 x desktop file rack (40465)
- 10 x shelf lateral files (46503)
- 1 x sheet of file title labels (45203)
- The file rack features a lip at the front to allow you to sit it flush against the desk or on a shelf
- White file Rack 400 x 200mm





Quickvue Files and Kits

- Quickvue files are a unique alternative to suspension filing which solves the problem of files falling off metal rails
- The angled tab across the top of each file allows for easy visibility of all files
- Customise Lateral Filing Labels with Avery FilePro® software and Filing Labels (959095)
- Alternatively, use with Avery manual colour coding labels



Code	Description	Colour		Board Type	Box
166007	50 Files, 72 File Title labels	White	<input type="checkbox"/>	Heavyweight	50
49997	Single Drawer Package: 50 Files, 72 Title Labels, 1 File Rack 500x390mm	White	<input type="checkbox"/>	Heavyweight	Package
49996	Two Drawer Package: 100 Files, 144 Title Labels, 2 File Racks 500x390mm	White	<input type="checkbox"/>	Heavyweight	Package
49998	Four Drawer Package: 200 Files, 288 Title Labels, 4 File Racks 500x390mm	White	<input type="checkbox"/>	Heavyweight	Package



Outguide

- Outguide with yellow tab for shelf lateral filing system
- Used when a file is removed from a filing system
- Allows the file user to note down to who, when and where the file is going

Code	Description	Colour		Board Type	Box
41546	388 x 242mm	White with Yellow Tab	<input type="checkbox"/>	Extra Heavyweight	25



File Racks – Fold over.

- Suitable for 25mm shelf height
- Suitable for shelf filing
- Available in a variety of sizes to fit various cabinets and shelving
- The sturdy metal will not bend under the weight of your bulky documents



Code	Description	Size	Colour		Quantity
40451	Fold over	750 x 390mm	White	<input type="checkbox"/>	1
40452	Fold over	900 x 290mm	White	<input type="checkbox"/>	1
40448	Fold over	900 x 390mm	White	<input type="checkbox"/>	1
40460	Fold over	1060 x 375mm	White	<input type="checkbox"/>	1
40454	Fold over	1200 x 390mm	White	<input type="checkbox"/>	1



File Racks – Straight Edge

- Fits all shelves including bottom shelf, cupboard, custom built shelves
- Suits a variety of shelves, ideally suitable for bottom shelf, cupboard and custom build shelves
- Use in-conjunction with your lateral files to keep multiple files upright



Code	Description	Size	Colour		Quantity
40447	BEST SELLER Straight Edge (Drawer Cabinet)	500 x 390mm	White	<input type="checkbox"/>	1
40464	Straight Edge	750 x 390mm	White	<input type="checkbox"/>	1
40463	Straight Edge	900 x 390mm	White	<input type="checkbox"/>	1
40462	Straight Edge	1050 x 390mm	White	<input type="checkbox"/>	1
40461	Straight Edge	1200 x 390mm	White	<input type="checkbox"/>	1

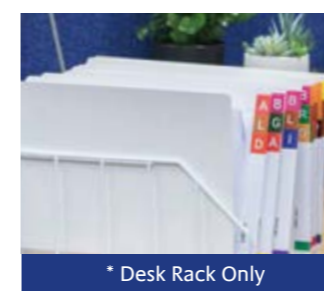

File Racks – Desktop Filing Rack

- The desktop file rack is economical in size, easy to move and versatile enough for use on the desk, on cabinets or shelves
- The file rack can be used with a variety of file types and sizes
- The file rack features a lip at the front to allow you to sit it flush against the desk or on a shelf



Code	Description	Size	Colour		Quantity
40465	Desk Rack Only	400 x 200mm	White	<input type="checkbox"/>	1



Lateral Filing Strip Label

- Specially designed to fit the tab area of lateral files
- Save time by printing on one label strip rather than applying individual tab labels
- Guaranteed Jam Free laser printing
- Designed for easy file identification
- FSC® certified labels made with paper from well-managed forests

Code	Description	Colour	Size	Labels per Pack
959095	4 Labels per Sheet	White	220 x 42mm	400



Customise your filing labels with **FREE Avery Filepro™ software**

filepro.averyproducts.com.au

- Easy to use online design tool to help label your files quickly
- Wide range of pre-designed templates
- Simple 3 step process: Select your template, Input data and Print!



Colour Coding Side Tab Labels Packs 180 – Alphabetical

- For easy identification of files
- Apply on the side of your files
- Each letter from 'A'-'Z', 'Mc' and forward slash is given a different colour for easy identification
- Also available in rolls of 500 to suit your preferences
- Available in alpha, numeric, year code and months

Code	Desc.	Colour	Size	Labels per Box
43301	A	Pink	25 x 38mm	180
43302	B	Magenta	25 x 38mm	180
43303	C	Orange	25 x 38mm	180
43304	D	Dark Orange	25 x 38mm	180
43305	E	Yellow	25 x 38mm	180
43306	F	Light Green	25 x 38mm	180
43307	G	Dark Green	25 x 38mm	180
43308	H	Blue	25 x 38mm	180
43309	I	Purple	25 x 38mm	180
43310	J	Mauve	25 x 38mm	180
43311	K	Brown	25 x 38mm	180
43312	L	Mustard	25 x 38mm	180
43313	M	Pink	25 x 38mm	180
43314	N	Magenta	25 x 38mm	180
43315	O	Orange	25 x 38mm	180
43316	P	Dark Orange	25 x 38mm	180
43317	Q	Yellow	25 x 38mm	180
43318	R	Light Green	25 x 38mm	180
43319	S	Dark Green	25 x 38mm	180
43320	T	Blue	25 x 38mm	180
43321	U	Purple	25 x 38mm	180
43322	V	Mauve	25 x 38mm	180
43323	W	Brown	25 x 38mm	180
43324	X	Mustard	25 x 38mm	180
43325	Y	White/Grey	25 x 38mm	180
43326	Z	Grey	25 x 38mm	180
43327	Mc	Black	25 x 38mm	180
43328	/	White/Black	25 x 38mm	180

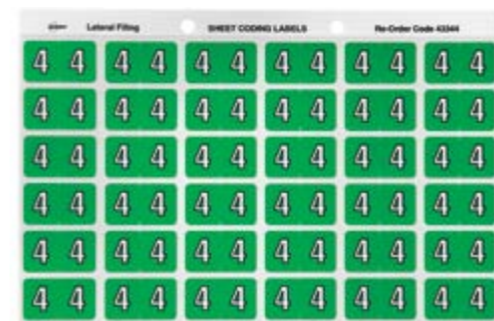

Colour Coding Side Tab Labels Packs 180 – Numeric

- For easy identification of files
- Apply on the side of your files
- Each number from '0'-'9' is given a different colour for easy identification
- Also available in rolls of 500 to suit your preferences
- Available in alpha, numeric, year code and months

Code	Desc.	Colour	Size	Labels per Box
43340	0	Pink	25 x 38mm	180
43341	1	Magenta	25 x 38mm	180
43342	2	Orange	25 x 38mm	180
43343	3	Dark Orange	25 x 38mm	180
43344	4	Light Green	25 x 38mm	180
43345	5	Dark Green	25 x 38mm	180
43346	6	Blue	25 x 38mm	180
43347	7	Purple	25 x 38mm	180
43348	8	Mauve	25 x 38mm	180
43349	9	Brown	25 x 38mm	180
43370	20 Year Code	Pink	25 x 38mm	180
43371	21 Year Code	Magenta	25 x 38mm	180



Colour Coding Side Tab Label Starter Kit

- Includes 72 of each alpha and numeric labels
- Apply on the side of your files
- Each alpha and number is given a different colour for easy identification

Code	Desc.	Colour	Size	Labels per Box
43399	Side Tab Colour Coding Label Kit	Assorted	25 x 38mm	72



Series 4 Colour Coding Side Tab Labels Pack 240 – Alphabetical

- Apply on the side of your files
- Each alpha from 'A'-'Z' including 'Mc' is given a different colour for easy identification
- Colour coding makes it easier to find files and eliminate misfiling

Code	Desc.	Colour	Size	Labels per Box
44501	A	Red	25 x 42mm	240
44502	B	Dark Green	25 x 42mm	240
44503	C	Yellow	25 x 42mm	240
44504	D	Blue	25 x 42mm	240
44505	E	Grey	25 x 42mm	240
44506	F	Pink	25 x 42mm	240
44507	G	Brown	25 x 42mm	240
44508	H	Light Green	25 x 42mm	240
44509	I	Orange	25 x 42mm	240
44510	J	Purple	25 x 42mm	240
44511	K	Red	25 x 42mm	240
44512	L	Dark Green	25 x 42mm	240
44513	M	Yellow	25 x 42mm	240
44514	N	Purple	25 x 42mm	240
44515	O	Blue	25 x 42mm	240
44516	P	Grey	25 x 42mm	240
44517	Q	Light Green	25 x 42mm	240
44518	R	Pink	25 x 42mm	240
44519	S	Brown	25 x 42mm	240
44520	T	Orange	25 x 42mm	240
44521	U	Red	25 x 42mm	240
44522	V	Dark Green	25 x 42mm	240
44523	W	Blue	25 x 42mm	240
44524	X	Pink	25 x 42mm	240
44525	Y	Purple	25 x 42mm	240
44526	Z	Light Green	25 x 42mm	240
44527	Mc	Brown	25 x 42mm	240

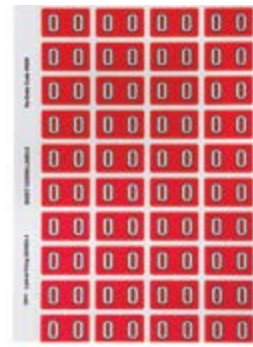

Series 4 Colour Coding Side Tab Labels Pack 240 – Numeric

- Apply on the side of your files
- Each number from '0'-'9' is given a different colour for easy identification
- Colour coding makes it easier to find files and eliminate misfiling

Code	Desc.	Colour	Size	Labels per Box
44528	0	Red	25 x 42mm	240
44529	1	Dark Green	25 x 42mm	240
44530	2	Yellow	25 x 42mm	240
44531	3	Blue	25 x 42mm	240
44532	4	Grey	25 x 42mm	240
44533	5	Pink	25 x 42mm	240
44534	6	Brown	25 x 42mm	240
44535	7	Light Green	25 x 42mm	240
44536	8	Orange	25 x 42mm	240
44537	9	Purple	25 x 42mm	240



Series 4 Side Tab Label Starter Kit

- Apply on the side of your file
- Colour coding makes it easier to find files and eliminate misfiling

Code	Desc.	Colour	Size	Labels per Box
44538	Starter Kit Alpha	Assorted	25 x 42mm	1 sheet of each A-Z = 1040 labels
44539	Starter Kit Numeric	Assorted	25 x 42mm	1 sheet of each 0-9 = 400 labels



Pre-printed Colour Coding Side Tab – Monthly

- Identify the right record with month coding labels
- Apply on the side of your files
- Each month from 'Jan' to 'Dec' is given a different colour for easy identification
- Works best together with year code for financial and accounting records

Code	Desc.	Colour	Size	Labels per Box
43401	January	Pink	23 x 38mm	180
43402	February	Red	23 x 38mm	180
43403	March	Orange	23 x 38mm	180
43404	April	Red	23 x 38mm	180
43405	May	Yellow	23 x 38mm	180
43406	June	Light Green	23 x 38mm	180
43407	July	Dark Green	23 x 38mm	180
43408	August	Blue	23 x 38mm	180
43409	September	Dark Blue	23 x 38mm	180
43410	October	Mauve	23 x 38mm	180
43411	November	Brown	23 x 38mm	180
43412	December	Mustard	23 x 38mm	180

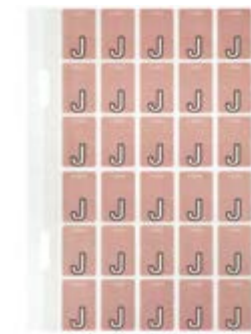

Pre-printed Colour Coding Top Tab – Alphabetical

- Easily identify files by using alphabetical top tab colour coding labels
- Apply on the top of your files
- Each alphabet from 'A'-'Z' including 'Mc' and forward slash is given a different colour for easy identification
- Suitable for Quickvue™ files or twin tab files

Code	Desc.	Colour	Size	Labels per Pack
44401	A	Pink	20 x 30mm	150
44402	B	Magenta	20 x 30mm	150
44403	C	Orange	20 x 30mm	150
44404	D	Dark Orange	20 x 30mm	150
44405	E	Yellow	20 x 30mm	150
44406	F	Light Green	20 x 30mm	150
44407	G	Dark Green	20 x 30mm	150
44408	H	Blue	20 x 30mm	150
44409	I	Purple	20 x 30mm	150
44410	J	Mauve	20 x 30mm	150
44411	K	Brown	20 x 30mm	150
44412	L	Mustard	20 x 30mm	150
44413	M	Pink/Stripe	20 x 30mm	150
44414	N	Magenta/Stripe	20 x 30mm	150
44415	O	Orange/Stripe	20 x 30mm	150
44416	P	Dark Orange/Stripe	20 x 30mm	150
44417	Q	Yellow/Stripe	20 x 30mm	150
44418	R	Light Green/Stripe	20 x 30mm	150
44419	S	Dark Green/Stripe	20 x 30mm	150
44420	T	Blue/Stripe	20 x 30mm	150
44421	U	Purple/Stripe	20 x 30mm	150
44422	V	Mauve/Stripe	20 x 30mm	150
44423	W	Brown	20 x 30mm	150
44424	X	Mustard	20 x 30mm	150
44425	Y	White/Grey	20 x 30mm	150
44426	Z	Grey	20 x 30mm	150
44427	Mc	Black/Stripe	20 x 30mm	150
44428	/	White/Black	20 x 30mm	150



Top Tab Coding Label Starter Kit

- Easily identify files by using numeric top tab colour coding labels. Apply on the top of your files.
- Each number from '0'-'9' is given a different colour for easy identification.
- Suitable for Quickvue™ files or twin tab files.

Code	Desc.	Colour	Size	Labels per Box
43300	Label Starter Kit	Assorted	20 x 30mm	60 Alpha & Numeric Labels

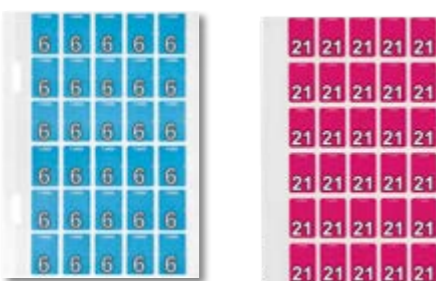

Pre-printed Colour Coding Top Tab – Numerical

- Easily identify files by using numeric top tab colour coding labels.
- Apply on the top of your files.
- Each number from '0'-'9' is given a different colour for easy identification.

Code	Description	Colour	Size	Labels per Box
44200	0	Pink	20 x 30mm	150
44201	1	Magenta	20 x 30mm	150
44202	2	Orange	20 x 30mm	150
44203	3	Dark Orange	20 x 30mm	150
44204	4	Light Green	20 x 30mm	150
44205	5	Dark Green	20 x 30mm	150
44206	6	Light Blue	20 x 30mm	150
44207	7	Purple	20 x 30mm	150
44208	8	Mauve	20 x 30mm	150
44209	9	Brown	20 x 30mm	150
44240	20 Year Code	Pink	20 x 30mm	150
44241	21 Year Code	Magenta	20 x 30mm	150
44242	22 Year Code	Orange	20 x 30mm	150

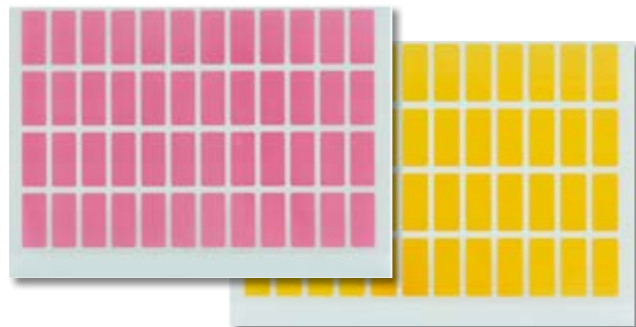

Solid Colour Only Labels

- Apply on the side or top of your files.
- Suitable for lateral file segregation for easy identification.
- Available in 10 different colours.

Code	Colour	Size	Labels per Box
44540	Black	19 x 42mm	240
44541	Brown	19 x 42mm	240
44542	Dark Green	19 x 42mm	240
44543	Light Green	19 x 42mm	240
44544	Orange	19 x 42mm	240
44545	Pink	19 x 42mm	240
44546	Purple	19 x 42mm	240
44547	Red	19 x 42mm	240
44548	Yellow	19 x 42mm	240
44549	Light Blue	19 x 42mm	240



Pre-printed Colour Coding Side Tab – Alphabetical

- Easily identify files by using alphabetical side tab colour coding labels.
- Apply on the side of your files.
- Each letter from 'A'-'Z' and 'Mc' is given a different colour for easy identification. Available in sheets to suit your preferences.
- Also available in alpha, numeric and year code.

Code	Desc.	Colour	Size	Labels per Box
43201	A	Pink	25 x 38mm	500
43202	B	Magenta	25 x 38mm	500
43203	C	Orange	25 x 38mm	500
43204	D	Dark Orange	25 x 38mm	500
43205	E	Yellow	25 x 38mm	500
43206	F	Light Green	25 x 38mm	500
43207	G	Dark Green	25 x 38mm	500
43208	H	Blue	25 x 38mm	500
43209	I	Purple	25 x 38mm	500
43210	J	Mauve	25 x 38mm	500
43211	K	Brown	25 x 38mm	500
43212	L	Mustard	25 x 38mm	500
43213	M	Pink	25 x 38mm	500
43214	N	Magenta	25 x 38mm	500
43215	O	Orange	25 x 38mm	500
43216	P	Dark Orange	25 x 38mm	500
43217	Q	Yellow	25 x 38mm	500
43218	R	Light Green	25 x 38mm	500
43219	S	Dark Green	25 x 38mm	500
43220	T	Blue	25 x 38mm	500
43221	U	Purple	25 x 38mm	500
43222	V	Mauve	25 x 38mm	500
43223	W	Brown	25 x 38mm	500
43224	X	Mustard	25 x 38mm	500
43225	Y	White/Grey	25 x 38mm	500
43226	Z	Grey	25 x 38mm	500
43227	Mc	Black	25 x 38mm	500



Pre-printed Colour Coding Side Tab – Numerical

- For easy identification of files.
- Apply on the side of your files.
- Each letter from '0'-'9' is given a different colour – Also available in sheets to suit your preferences.
- Available in alpha, numeric and year code.

Code	Desc.	Colour	Size	Labels per Box
43240	0	Pink	25 x 38mm	500
43241	1	Magenta	25 x 38mm	500
43242	2	Orange	25 x 38mm	500
43243	3	Dark Orange	25 x 38mm	500
43244	4	Light Green	25 x 38mm	500
43245	5	Dark Green	25 x 38mm	500
43246	6	Blue	25 x 38mm	500
43247	7	Purple	25 x 38mm	500
43248	8	Mauve	25 x 38mm	500
43249	9	Brown	25 x 38mm	500



Pre-printed Colour Coding Side Tab – Yearly

- Organise files by year for easy identification.
- Apply on the side of your files.
- Also available in pack of 180 to suit your preferences.

Code	Description	Colour	Size	Labels per Box
43270	20 Year Code	Pink	25 x 38mm	500
43271	21 Year Code	Magenta	25 x 38mm	500
43272	22 Year Code	Orange	25 x 38mm	500

Lateral Filing Starter Kits

- Starter kits contain all you need to begin your new Avery Lateral Filing System
- Free Filepro™ Software



A101240 Lateral Filing Starter Kit 1

- Includes 100 Shelf Lateral Files (46503)
- 400 Avery Lateral Filing Labels (959095)
- Free Filepro™ Software



203280 Lateral Filing Starter Kit 2

- Includes 300 Shelf Lateral Files (46503)
- 400 Avery Lateral Filing Labels (959095)
- Free Filepro™ Software



203290 Lateral Filing Starter Kit 3

- Includes 300 Shelf Lateral Files (46503)
- 400 Avery Lateral Filing Labels (959095)
- 200 Yellow TUBECLIP® Fasteners 3 piece set (44009Y)
- Free Filepro™ Software



203270 Lateral Filing Starter Kit 4

- Includes 500 Shelf Lateral Files (46503)
- 800 Avery Lateral Filing Labels (959095)
- Free Filepro™ Software



203260 Lateral Filing Starter Kit 5

- Includes 250 Formakote Shelf Lateral Files (46720)
- 25 Concertina Wallets (46718)
- 400 Avery Lateral Filing Labels (959095)
- Free Filepro™ Software

Lateral Filing Packages

- Wide range of Avery smart filing packages
- Help to convert existing cabinetry into a customisable Lateral Filing System
- Free Filepro™ Software



A101230 Lateral Filing Package

- Includes 300 Shelf Lateral Files (46503)
- 300 Yellow TUBECLIP® Fasteners 3 piece set (44009Y)
- 400 Avery Lateral Filing Labels (959095)
- 25 Outguide with yellow tab (41546)
- Free Filepro™ Software



A201260 Lateral Filing Package 2

- Includes 600 Shelf Lateral Files (46503)
- 600 Yellow TUBECLIP® Fasteners 3 piece set (44009Y)
- 400 Avery Lateral Filing Labels (959095)
- 25 Outguide with yellow tab (41546)
- Free Filepro™ Software



A401260 Lateral Filing Package 3

- Includes 5 File Racks 900x390mm (40448)
- File Rack Straight Edge 1200x390mm (40461)
- 600 Shelf Lateral Files (46503)
- 600 Yellow TUBECLIP® Fasteners 3 piece set (44009Y)
- 800 Avery Lateral Filing Labels (959095)
- 25 Outguide with yellow tab (41546)
- Free Filepro™ Software



A301260 Lateral Filing Package 4

- Includes 5 File Racks 1200x390mm (40454)
- File Rack Straight Edge 1200x390mm (40461)
- 600 Shelf Lateral Files (46503)
- 600 Yellow TUBECLIP® Fasteners 3 piece set (44009Y)
- 800 Avery Lateral Filing Labels (959095)
- 25 Outguide with yellow tab (41546)
- Free Filepro™ Software



Save time and space with
Avery Lateral Filing System

Avery Lateral Filing Systems can save up to **70%** more office space

Conventional Filing Cabinet



- Low initial outlay but higher long term costs and ineffective solution
- Manufactured offshore – cheaper quality
- Takes up more floor space
- More time consuming to locate files
- Potential safety hazard if weight is uneven

Lateral Filing Cabinet

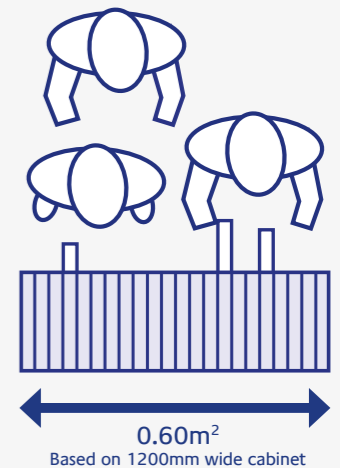

- Moderate initial outlay but more cost-effective long term solution
- Australian made – sturdy construction
- Saves up to 70% floor space
- Colour coding makes locating files easier
- Reduces misfiling & filing time by 50%

Customise your filing labels with Free Avery Filepro™ software, available at filepro.averyproducts.com.au

Lateral Filing Cabinet Packages



To order Lateral Filing Cabinets with stock packages, please contact Furnx.

Contact number: 0490 071 822

Email: rob.clements@furnx.com.au



White

Code
20261/A201260

Cabinet Colour

20262OG	Oyster Grey	
20262MA	Magnolia	
20262WHT	White	
20262GR	Graphite Ripple	

Cabinet Size
1980mm H x 1200mm W x 500mm D

Description
Lateral Filing Cabinet Package

- 1 lockable door cabinet with 5 adjustable shelves
- Ideal storage solution for medium to large offices
- Kit includes:
600 extra heavy weight white foolscap lateral files (46503) and 600 TUBECLIP® file fasteners (44009Y)
- 25 Outguides (41546) – Used when a file is removed from a filing system
- 400 lateral filing labels (959095)
- Customise your filing labels with Free Avery Filepro™ software, available at filepro.averyproducts.com.au



Magnolia

Code
20263/A201260

Cabinet Colour

20263OG	Oyster Grey	
20263MA	Magnolia	
20263WHT	White	
20263GR	Graphite Ripple	

Cabinet Size
1980mm H x 900mm W x 500mm D

Description
Lateral Filing Cabinet Package

- 1 lockable door cabinet with 5 adjustable shelves
- Ideal storage solution for medium to large offices
- Kit includes:
600 extra heavy weight white foolscap lateral files (46503) and 600 TUBECLIP® file fasteners (44009Y)
- 25 Outguides (41546) – Used when a file is removed from a filing system
- 400 lateral filing labels (959095)
- Customise your filing labels with Free Avery Filepro™ software, available at filepro.averyproducts.com.au

For more information on cabinet packages or Open Bay cabinets please call customer service on 1800 644 353 Australia, 0800 228 379 New Zealand

Lateral Filing Cabinet Packages



White

Code
20262/A101230

Cabinet Colour

20262OG	Oyster Grey	
20262MA	Magnolia	
20262WHT	White	
20262GR	Graphite Ripple	

Cabinet Size
1000mm H x 1200mm W x 500mm D

Description
Lateral Filing Cabinet Package

- 1 lockable door cabinet with 2 adjustable shelves and the base of cabinet, 3 rear stops, and 9 shelf dividers
- Ideal storage solution for small to medium offices
- Kit includes:
300 extra heavy weight white foolscap lateral files (46503) and 300 TUBECLIP® file fasteners (44009Y)
- 25 Outguides (41546) – Used when a file is removed from a filing system
- 400 lateral filing labels (959095)
- Customise your filing labels with Free Avery Filepro™ software, available at filepro.averyproducts.com.au



Oyster Grey

Code
20264/A101230

Cabinet Colour

20261OG	Oyster Grey	
20261MA	Magnolia	
20261WHT	White	
20261GR	Graphite Ripple	

Cabinet Size
1000mm H x 900mm W x 500mm D

Description
Lateral Filing Cabinet Package

- 1 lockable door cabinet with 2 adjustable shelves and the base of cabinet, 3 rear stops, and 9 shelf dividers
- Ideal storage for small to medium offices
- Kit includes:
300 extra heavy weight white foolscap lateral files (46503) and 300 TUBECLIP® file fasteners (44009Y)
- 25 Outguides (41546) – Used when a file is removed from a filing system
- 400 lateral filing labels (959095)
- Customise your filing labels with Free Avery Filepro™ software, available at filepro.averyproducts.com.au



Filing & Dividers

Our range of files, fasteners, dividers and title labels will help you to stay organised & provide colour coded options to suit your needs.



Minimise clutter and simplify your life, whether you're in the office, at home or school, by using Avery manilla folders and dividers which are strong and versatile. Add a fastener so that your documents are secure and file title labels for a professional finish.

Filing Folder Dimensions and Weights Guide	
DIMENSIONS	
A4	320 x 241mm
Foolscap	355 x 241mm
Legal	388 x 241mm
WEIGHTS	
Heavy Weight	240 – 250gsm
Extra Heavyweight	300 – 325gsm
Super Weight	370 – 380gsm



Buff Manilla Folder

- Avery manilla folders offer the highest quality from a strong and durable manilla board
- Ideal for projects or personal files and suitable for compact archiving into storage systems
- Available in a range of colours and in foolscap and A4 sizes
- FSC® certified board made with paper from well-managed forests and other controlled sources





Code	Colour		Size	Box
82703	Buff	■	A4	20
88055	Buff	■	A4	50
81702	Buff	■	A4	100
88051	Buff	■	Foolscap	10
88200	Buff	■	Foolscap	20
88225	Buff	■	Foolscap	25
88050	Buff	■	Foolscap	50
81502	Buff	■	Foolscap	100
88160	Buff Extra Heavyweight	■	Foolscap	10
81504	Buff Extra Heavyweight	■	Foolscap	100



Buff Manilla Folders – Tabbed

- Manufactured from durable manilla board
- 5 tabs for easy identification
- Available in 5 pack or 50 pack
- FSC® certified board made with paper from well-managed forests and other controlled sources

Code	Colour		Size	Box
81556	Buff (Fifth cut 1 set of 5)	■	Foolscap	5
81557	Buff (Fifth cut 10 sets of 5)	■	Foolscap	50



Coloured Manilla Folders

- Avery manilla folders offer the highest quality from a strong and durable manilla board
- Ideal for projects or personal files and suitable for compact archiving into storage systems
- Available in a range of colours and in foolscap and A4 sizes
- FSC® certified board made with paper from well-managed forests and other controlled sources



Code	Colour	Size	Box
83712	Red	A4	10
83722	Blue	A4	10
83742	Yellow	A4	10
82723	Blue	A4	20
82733	Green	A4	20
82743	Yellow	A4	20
82753	Pink	A4	20
82713	Red	A4	20
81712	Red	A4	100
81722	Blue	A4	100
81732	Green	A4	100
81742	Yellow	A4	100
81752	Pink	A4	100
88151	Assorted (Blue, Red, Green, Yellow)	Foolscap	10
88154	Black Heavyweight	Foolscap	10
88155	White Heavyweight	Foolscap	10
88150	Assorted (Blue, Red, Green, Yellow)	Foolscap	20
88212	Red	Foolscap	20
88222	Blue	Foolscap	20
88229	Grey	Foolscap	20
88232	Green	Foolscap	20
88242	Yellow	Foolscap	20
88252	Pink	Foolscap	20
88272	Orange	Foolscap	20
88282	Light Blue	Foolscap	20
88292	Purple	Foolscap	20
81512	Red	Foolscap	100
81522	Blue	Foolscap	100
81529	Grey	Foolscap	100
81532	Green	Foolscap	100
81533	Light Green	Foolscap	100
81542	Yellow	Foolscap	100
81552	Pink	Foolscap	100
81572	Orange	Foolscap	100
81582	Light Blue	Foolscap	100
81592	Purple	Foolscap	100
81593	Assorted (Blue, Red, Green, Yellow & Pink)	Foolscap	100



Coloured Manilla Folders with Labels

- Add a professional look to your Avery manilla folders by using your laser printer
- Ideal for projects or personal files and suitable for compact archiving into storage systems
- 20 manilla folders, 1 sheet of 24 laser file title labels
- FSC® certified board made with paper from well-managed forests and other controlled sources



Code	Colour	Size	Box
88300	Buff	Foolscap	20
88312	Red	Foolscap	20
88322	Blue	Foolscap	20
88350	Assorted (Blue, Red, Green, Yellow)	Foolscap	20



Buff Manilla Folder with Fasteners

- Extra heavy weight board
- Ideal for securing papers and adding pages to the top of the file
- Each file is fitted with either a TUBECLIP®, Permclip or Spiral Spring Action Fastener which allows papers to be secured and easily accessed whenever required



Code	Fastener	Colour	Size	Box
85003	Permclip	Buff	Foolscap	100
87003	Permclip	Buff	A4	100
88551	TUBECLIP®	Buff	Foolscap	5
84504	Spiral Spring Action	Buff	Foolscap	25
84505	TUBECLIP®	Buff	Foolscap	20



Pre-Printed Manilla Folder with Fastener

- Extra heavy duty folder fitted with a spiral spring coil fastener and pressure plate
- Available in buff, red, blue green and yellow
- Secures documents to your file, so they do not fall out
- Each folder is fitted with either a Spiral Spring Action Fastener or Spiral Spring Transfer Fastener which allows papers to be secured and easily accessed whenever required



Code	Fastener	Colour	Size	Box
88544	Spiral Spring Action	Red / Black Print	Foolscap	5
88545	Spiral Spring Action	Blue / Black Print	Foolscap	5
88546	Spiral Spring Action	Green / Black Print	Foolscap	5
88547	Spiral Spring Action	Yellow / Black Print	Foolscap	5
88550	Spiral Spring Action	Assorted / Black Print	Foolscap	5
85104	Spiral Spring Action	Red / Black Print	Foolscap	25
85204	Spiral Spring Action	Blue / Black Print	Foolscap	25
85304	Spiral Spring Action	Green / Black Print	Foolscap	25
85404	Spiral Spring Action	Yellow / Black Print	Foolscap	25
86514	Spiral Spring Action	Buff / Red Print	Foolscap	25
86524	Spiral Spring Action	Buff / Blue Print	Foolscap	25
86534	Spiral Spring Action	Buff / Green Print	Foolscap	25
86804	Spiral Spring Transfer	Buff	Foolscap	25
86814	Spiral Spring Transfer	Red	Foolscap	25
86824	Spiral Spring Transfer	Blue	Foolscap	25
86834	Spiral Spring Transfer	Green	Foolscap	25



Pre-Printed Manilla Folders with Fasteners

- A long lasting, extra heavy weight board with a TUBECLIP® fastener
- Ideal for projects or personal files and suitable for compact archiving into storage systems
- Available in buff with colour print for a classic look
- Each folder is fitted with a TUBECLIP® which allows papers to be secured and easily accessed whenever required



Code	Fastener	Colour	Size	Box
88552	TUBECLIP®	Red Print	Foolscap	5
88553	TUBECLIP®	Blue Print	Foolscap	5
88554	TUBECLIP®	Green Print	Foolscap	5
84515	TUBECLIP®	Red Print	Foolscap	20
84525	TUBECLIP®	Blue Print	Foolscap	20
84535	TUBECLIP®	Green Print	Foolscap	20
88412	TUBECLIP®	Red File	Foolscap	5
88422	TUBECLIP®	Blue File	Foolscap	5
88432	TUBECLIP®	Green File	Foolscap	5
88442	TUBECLIP®	Yellow File	Foolscap	5
88452	TUBECLIP®	Assorted	Foolscap	5
84412	TUBECLIP®	Red File	Foolscap	20
84422	TUBECLIP®	Blue File	Foolscap	20
84432	TUBECLIP®	Green File	Foolscap	20
84442	TUBECLIP®	Yellow File	Foolscap	20



TUBECLIP® File Fasteners

Avery Coloured TUBECLIPs are designed for adding, removing, scanning and photocopying paperwork and can be added to any Manilla or Lateral file. They expand as your files expand and hold up to 90mm of paper.

Avery TUBECLIP® three piece sets consists of a self-adhesive base which adheres to the file, a plastic compressor bar which is placed on top of the pages to keep them in place, and a plastic U piece which inserts into the compressor bar to secure your documents.



Avery Non-Adhesive Unitubes

Avery Unitube fasteners are ideal for archiving and permanent storage of your paperwork and can also be placed in commercial shredders. They come in a convenient 3 piece set or base only pack and including a plastic non-adhesive tube.

TUBECLIP® File Fasteners

Code	Colour	Description	Box
44005B	Blue	3 Piece Set	10
44005R	Red	3 Piece Set	10
44005Y	Yellow	3 Piece Set	10
44009B	Blue	3 Piece Set	100
44009R	Red	3 Piece Set	100
44009Y	Yellow	3 Piece Set	100
44001	Yellow	3 Piece Set Non Adhesive	500

Avery Coloured TUBECLIP® Refill Options

Code	Colour	Description	Box
44007B	Blue	U Piece only	25
44007Y	Yellow	U Piece only	25
44008B	Blue TUBECLIP®	Compressor Bar	25
44008Y	Yellow TUBECLIP®	Compressor Bar	25
44006	White	Base Only	100

Avery Non-Adhesive Unitubes

Code	Colour	Description	Box
44021	Yellow	3 Piece Set	500
44007	White	Base Only	100





Permclip File Fasteners

- Two pronged enamelled fastener with a self adhesive base
- Suitable for archiving and holding heavy documents
- Can be adhered to any file, perfect for securing documents
- Available in 20/box or 100/box for heavy usage

Code	Colour	Size	Box
80695	White	<input type="checkbox"/> 2 prong fastener	20
80699 BEST SELLER	White	<input type="checkbox"/> 2 prong fastener	100



Quickclip Fastener

- Lever arch file plastic coated metal clip in one complete unit
- Adhesive on the base sticks to file and the 2 metal prongs bend up in order to add documents
- Ideal for presentation folders and slim files

Code	Colour	Size	Box
80692	White	<input type="checkbox"/> 2 prong fastener	50



White Everfast Pin Holder

- Durable label designed for fixing split pins inside files
- Self adhesive material that is tear resistant
- Reinforce pins for durability

Code	Colour	Size	Box
81996	White printed Black	<input checked="" type="checkbox"/> File Pin Holder	300



Print & Apply Clear Dividers Laser / Inkjet

- Translucent clear tab labels virtually disappear behind text
- Organise your documents quickly and easily
- Customise your tab labels with our free and easy-to-use template software; Avery Design and Print – available at averyproducts.com.au/print
- Simply print, align labels against tabs, smooth down labels and peel up strip



Code	Software Code	Colour	Description	Size
5111081	L7455-5	Clear	<input type="checkbox"/> 5 Tab	A4
5113081 BEST SELLER	L7455-10	Clear	<input type="checkbox"/> 10 Tab	A4



Print & Apply Label Dividers Laser / Inkjet

- Easy Apply labels allow you to apply all tab labels at once!
 - Simply print, align labels against tabs, smooth down labels and peel up strip
 - Customise your tab labels with our free and easy-to-use template software; Avery Design and Print – available at averyproducts.com.au/print
 - Organise your documents quickly and easily
- Unpunched**
- Unpunched for use with wire and comb binding systems
- Extra Wide**
- Extra wide tabs



Code	Software Code	Colour	Description	Size
930113	L7455-10	White	<input type="checkbox"/> 10 Tab	A4
Unpunched				
930160	L7455-5	White	<input type="checkbox"/> 5 Tab	A4
930161	L7455-10	White	<input type="checkbox"/> 10 Tab	A4



Print On Tabs Removable Laser / Inkjet

- Self adhesive repositionable tabs
- Ideal for dividing and marking of specific pages or parts of pages in catalogues, bound documents, diaries, hanging file systems, reports, text books and more
- Customise your tabs with our free and easy-to-use template software; Avery Design and Print – available at averyproducts.com.au/print
- Attach to the edge of any size page







Code	Software Code	Colour	Description	Size
5412561	L7431	White <input type="checkbox"/>	48 Tabs	A4
5412501	L7431	Assorted <input checked="" type="checkbox"/>	48 Tabs	A4



Dividers with Pre Printed Tabs

Customisable Table of Contents – Brightly Coloured Tab Dividers Laser / Inkjet

- Simply flip the dividers and table of contents to use in landscape or portrait format depending upon your preference.
- Laser or inkjet compatible
- Customise your table of contents with our free and easy-to-use template software; Avery Design and Print – available at averyproducts.com.au/print
- Ideal when presentation is important
- Strong plastic tab reinforcement
- FSC® certified board made with paper from well-managed forests and other controlled sources



Code	Software Code	Colour	Description	Size
922002	L7411-5	Multi Coloured <input checked="" type="checkbox"/>	1-5 Tab	A4
922004 BEST SELLER	L7411-10	Multi Coloured <input checked="" type="checkbox"/>	1-10 Tab	A4
922006	L7411-15	Multi Coloured <input checked="" type="checkbox"/>	1-15 Tab	A4
922007	L7411-26	Multi Coloured <input checked="" type="checkbox"/>	A-Z Tab	A4



Dividers with Pre Printed Tabs



White Plastic Pre Printed Dividers Laser / Inkjet

- Manufactured from durable polypropylene
- Punched with 11 holes for use in all files and ring binders
- Customise your table of contents with our free and easy-to-use template software; Avery Design and Print – available at averyproducts.com.au/print
- Ideal for documents which are regularly accessed

Extra Wide

- Extra width for use with sheet protectors
- Ideal for documents which are regularly accessed
- Customise your table of contents with our free and easy-to-use template software; Avery Design and Print – available at averyproducts.com.au/print



Code	Colour		Description	Size
85605	White	<input type="checkbox"/>	1-5 Tab	A4
85610	White	<input type="checkbox"/>	1-10 Tab	A4
85612	White	<input type="checkbox"/>	1-12 Tab	A4
85620	White	<input type="checkbox"/>	1-20 Tab	A4
85631	White	<input type="checkbox"/>	1-31 Tab	A4
85654	White	<input type="checkbox"/>	1-54 Tab	A4
85622	White	<input type="checkbox"/>	A-Z Tab	A4
85613	White	<input type="checkbox"/>	Jan-Dec Tab	A4
Extra Wide				
85660	White	<input type="checkbox"/>	1-10 Tab	A4

Dividers with Pre Printed Tabs



Plastic Multi Coloured Dividers

- Made from environmentally friendly polypropylene
- Bright colour polypropylene dividers
- Ideal for documents which are frequently accessed
- Punched with 11 holes for use in all files and ring binders

Extra Wide

- Extra width for use with sheet protectors
- Ideal for documents which are regularly accessed
- Customise your table of contents with our free and easy-to-use template software; Avery Design and Print – available at averyproducts.com.au/print



Code	Colour		Description	Size
Extra Wide				
85665	Multi Coloured	<input type="checkbox"/>	1-5 Tab	A4
85670	Multi Coloured	<input type="checkbox"/>	1-10 Tab	A4



Plastic Insertable Dividers

- Blank inserts for tabs provided which can be easily labelled, rearranged or changed
- Manufactured from durable polypropylene
- Ideal for documents which are regularly accessed
- Punched with 11 holes for use in all files and ring binders



Code	Colour		Description	Size
Extra Wide				
85675	Multi Coloured	<input type="checkbox"/>	5 Tab	A4

Manilla Board Dividers



Pre Printed Dividers

- Tear-proof tabs and plastic reinforced spine for durability
- Quality white manilla board
- Ideal for documents which are frequently accessed
- Punched with 11 holes for use in all files and ring binders
- FSC® certified board made with paper from well-managed forests and other controlled sources



Code	Colour		Description	Size
Fluoro Tabs				
85713	White	<input type="checkbox"/>	Jan-Dec	A4
85723	White	<input type="checkbox"/>	1-10 Tab	A4
85732	White	<input type="checkbox"/>	5 Tab	A4
85743	White	<input type="checkbox"/>	A-Z	A4



Write & Erase Multi Coloured Tab Dividers

- Erasable laminated tabs allows tabs to be reused when you need
- Quality white manilla board
- Plastic reinforced spine for durability
- Multi-punched to fit all standard files and binders
- FSC® certified board made with paper from well-managed forests and other controlled sources



Code	Colour		Description	Size
85601	White	<input type="checkbox"/>	10 Tab	A4

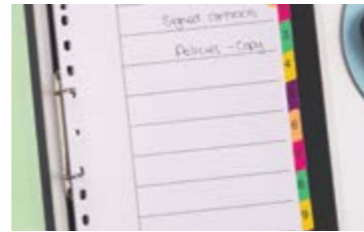

Conferencing

Stick, forget and connect.

Name badges have the power to create conversations. From contacts, to contracts. Opportunities to connections. At Avery, we understand the power of connection.



Fabric Print & Divide Name Badge Labels Laser

- Made from flexible acetate satin fabric material that is suitable for all types of fabric and can be removed without leaving residue
- Print & Divide feature allows you to divide, sort and distribute your badges easily
- Unique material allows movement and does not curl or fall off
- Easily import your contacts with Avery Design & Print software and is compatible with Microsoft® Word Templates
- Optimised for laser printers and copiers

Code	Software Code	Colour	Size	Labels per Sheet	Sheets per Pack	Labels per Pack
980040	L7427	White	88 x 52mm	10	15	150

Fabric Name Badge Labels Laser

- Made from flexible acetate satin fabric material that is suitable for all types of fabric and can be removed without leaving residue
- Label can be removed without leaving residue on any fabric
- Unique material allows movement and does not curl or fall off
- Easily import your contacts with Avery Design & Print software and is compatible with Microsoft® Word Templates
- Optimised for laser printers and copiers

Code	Software Code	Colour	Size	Labels per Sheet	Sheets per Pack	Labels per Pack
959171	L7418	White	86.5 x 55.5mm	8	15	120
959170	L4784	White	63.5 x 29.6mm	27	15	405

Card Name Badge Kit Laser / Inkjet

- Includes 24 card inserts and 20 PVC-free badge holders that can be attached by a clip or pin
- Premium quality matt white card to display your attendee's names and company logo
- Easily import your contacts with Avery Design & Print software and is compatible with Microsoft® Word Templates
- Optimised for laser and inkjet printers and copiers

Code	Software Code	Colour	GSM	Size	Cards per Sheet	Sheets per Pack	Cards per Pack
959077	L7418K	White	150gsm	86.5 x 55.5mm	8	3	24

Card Name Badges Refill Laser / Inkjet

- Refill contains 25 sheets each with 8 perforated name badges
- Premium quality matt white card to display your attendee's names and company logo
- Ideal for branding your events, networking and conferences
- Easily import your contacts with Avery Design & Print software and is compatible with Microsoft® Word Templates
- Optimised for laser and inkjet printers and copiers

Code	Software Code	Colour	GSM	Size	Cards per Sheet	Sheets per Pack	Cards per Pack
947002	L7418K	White	150gsm	86.5 x 55.5mm	8	25	200

Delegate Cards Laser / Inkjet

- Matt white heavyweight card provides an optimal base for vivid graphics and sharp text
- Ideal for branding your events, networking and conferences
- Easily import your contacts with Avery Design & Print software and is compatible with Microsoft® Word Templates
- Optimised for laser and inkjet printers and copiers

Code	Software Code	Colour	GSM	Size	Cards per Sheet	Sheets per Pack	Cards per Pack
947000	L7423	White	150gsm	210 x 74.25mm	2	25	50

Place Cards Laser / Inkjet

- Matt white heavyweight card provides an optimal base for vivid graphics and sharp text
- Ideal for branding your events, networking and conferences
- Easily import your contacts with Avery Design & Print software and is compatible with Microsoft® Word Templates
- Optimised for laser and inkjet printers and copiers

Code	Software Code	Colour	GSM	Size	Cards per Sheet	Sheets per Pack	Cards per Pack
982503	C32073	White	260gsm	85 x 50mm (folded size)	4	10	40

Multi-Purpose Cards Laser / Inkjet

- Matt white heavyweight card provides an optimal base for vivid graphics and sharp text
- Ideal for branding your events, networking and conferences
- Easily import your contacts with Avery Design & Print software and is compatible with Microsoft® Word Templates
- Optimised for laser and inkjet printers and copiers

Code	Software Code	Colour	GSM	Size	Cards per Sheet	Sheets per Pack	Cards per Pack
982504	C32072	White	260gsm	85 x 54mm	8	5	40

Hello I'm Roll Label

- Bright pre-printed labels for immediate recognition
- Labels come in a handy dispenser pack for ease of use
- Great for often repeated tasks when you require easy access to labels
- Removable adhesive

Code	Colour	Size	Labels per Roll
937263	White printed blue	58 x 43mm	100

Cling Sheet

- Reusable with whiteboard markers
- Won't damage walls
- Reposition again and again
- Portable: roll it and go

Code	Colour	Description	Size
930101	White	Write On Cling Sheet Removable	667 x 864mm

DESIGN. PRINT. GO!®

Use your contact list to personalise your next event:

averyproducts.com.au/print



Business Cards

Take your brand to the next level!

Create your own customised cards within minutes direct from your home or office printer – saving you time and money by only printing the number of cards you need.

1

Select

- Go to averyproducts.com.au/print or avery.co.nz/print
- Click "Start Design & Print"
- Enter the software code (found on the label sheet or on the packaging)



2

Design

- Select a pre-designed or blank template



3

Import

- Click on the Click "Import Data Mail Merge", then "Import Data"
- Select your spreadsheet file

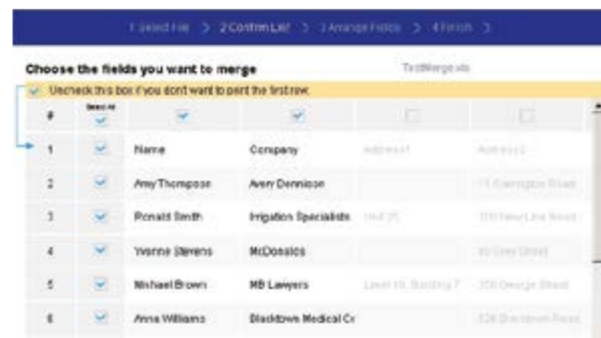

4



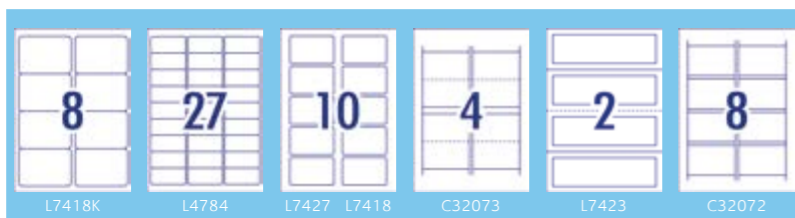

Print

- Click "Preview & Print"



Matt Business Cards Laser / Inkjet





- Heavyweight matt cardstock provides an optimal base for vivid graphics and sharp text
- Design and print only the number of cards you need within minutes direct from your home or office printer
- Create unique business card designs using Avery Design & Print software, also compatible with Microsoft® Word Templates
- Suitable for laser and inkjet printers

Code	Software Code	Colour	Card Separation	Print	Size	GSM	Cards per Sheet	Sheets per Pack	Cards per Pack	
936220	C32015	White	<input type="checkbox"/>	Quick & Clean	Double Sided	85 x 54 mm	260gsm	8	25	200
959025	L7414	White	<input type="checkbox"/>	Perforated	Single Sided	90 x 52 mm	150gsm	10	20	200
959078	C32011	White	<input type="checkbox"/>	Quick & Clean	Single Sided	85 x 54 mm	200gsm	10	25	250
959026	L7415	White	<input type="checkbox"/>	Perforated	Single Sided	90 x 52 mm	150gsm	10	100	1000

Satin Finish Business Cards Laser

- Heavyweight satin cardstock provides an optimal base for vivid graphics and sharp text
- Quick & Clean technology ensures perfectly smooth edges
- Print on both sides of the card to give more space for your design and key information
- Design and print only the number of cards you need within minutes direct from your home or office printer
- Create unique business card designs using Avery Design & Print software, also compatible with Microsoft® Word Templates
- Suitable for laser printers

Code	Software Code	Colour	Card Separation	Print	Size	GSM	Cards per Sheet	Sheets per Pack	Cards per Pack	
936230	C32026	White	<input type="checkbox"/>	Quick & Clean	Double Sided	85 x 54 mm	270gsm	10	10	100







Quick & Clean Technology
ensures perfectly smooth edges



Gloss Business Cards Inkjet



- Heavyweight gloss coated cardstock provides an optimal base for vivid graphics and sharp text
- Quick & Clean technology ensures perfectly smooth edges
- Print on both sides of the card to give more space for your design and key information
- Design and print only the number of cards you need within minutes direct from your home or office printer
- Create unique business card designs using Avery Design & Print software, also compatible with Microsoft® Word Templates
- Suitable for inkjet printers

Code	Software Code	Colour	Card Separation	Print	Size	GSM	Cards per Sheet	Sheets per Pack	Cards per Pack	
936229	C32028	White	<input type="checkbox"/>	Quick & Clean	Double Sided	85 x 54 mm	230gsm	8	10	80

Leathergrain Finish Business Cards Laser / Inkjet

- Heavyweight cardstock with a leathergrain texture finish, provides an optimal base for vivid graphics and sharp text
- Design and print only the number of cards you need within minutes direct from your home or office printer
- Create unique business card designs using Avery Design & Print software, also compatible with Microsoft® Word Templates
- Optimised for inkjet printers and copiers
- Premium leathergrain finish is optimized for vibrant colours and sharp text

Code	Software Code	Colour	Card Separation	Print	Size	GSM	Cards per Sheet	Sheets per Pack	Cards per Pack	
70450	I139	White	<input type="checkbox"/>	Perforated	Single Sided	90 x 52 mm	190gsm	10	20	200

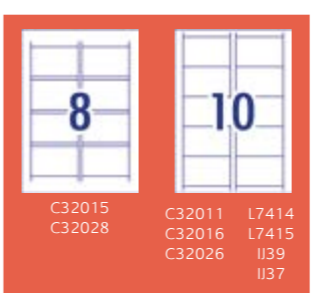

8 10

C32015 C32011 L7414
C32028 C32016 L7415
C32026 I139 I137



Presentation

Wow the audience with your presentation and create a good first impression when it really matters.

Create a professional look & add your own style with our range of display books, binders, document wallets, presentation files and handy pouches. Great for home, office or student applications, there is a solution tailored to your individual needs.

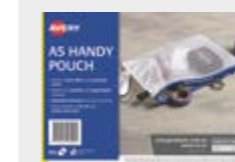

Handy Pouches

- Made from tear proof and water resistant clear PVC reinforced nylon
- Strong and durable to protect books, folders, files, pens, pencils and more
- Zip closure secures and protects contents
- Available in a range of sizes

Code	Colour	Description	Size
49500	Clear PVC	Zip	A3
49501	Clear PVC	Zip	A4
49502	Clear PVC	Zip	A5
49503	Clear PVC	Zip	325 x 145mm



Insertable Cover Display Book

- Customise the insert front cover
- Includes reversible spine label
- Made from durable polypropylene
- Suitable for presentation and storage

Code	Colour	Description	Size
47931	Navy	20 Pockets	A4
47932	Black	20 Pockets	A4
47935	Navy	40 Pockets	A4
47936	Black	40 Pockets	A4
47937*	Black	60 Pockets	A4

* Protective case for easy storage



Flexi View Display Book Clear Insertable Cover

- Clear window allows customising of front and inside cover
- Printed frames adds design and finish
- Customise the title page using software and templates from www.averyproducts.com.au
- Ideal for creating high quality, professional presentations and proposals
- Made from durable, non-stick polypropylene

Code	Colour	Description	Size
47693	Blue	24 Pockets	A4

Flexi View Binders

- Clear window allows customising of front and inside cover
- Printed frames adds design and finish
- Customise your title page with our free and easy-to-use template software; Avery Design and Print – available at averyproducts.com.au/print
- Holds 100 pages
- Made from durable, non-stick polypropylene



Translucent Document File

- Holds 200 sheets
- Elastic closures for security
- Made from durable polypropylene

Code	Colour	Description	Size
15766	Navy	2 Ring 1/2 inch	A4
15767	Black	2 Ring 1/2 inch	A4

Code	Colour	Description	Size
47709	Red	Capacity 25mm	A4
47712	Clear	Capacity 25mm	A4



Soft Cover Display Book

- Flexible soft cover display books
- Colour code your files and documents
- Insert pocket on inside covers
- Made from durable polypropylene



Polypropylene Document Wallets

- Holds 200 sheets
- Easily transport your documents
- Elastic closures for security
- Made from durable polypropylene

Code	Colour	Description	Size
49112	Blue	20 Pockets	A4
49113	Clear	20 Pockets	A4

Code	Colour	Description	Size
47707	Assorted	3 Flap Wallet	A4
47708	Clear	3 Flap Wallet	A4



Insert Cover Extra Wide Management File

- Extra wide files to fit copy safe pockets and dividers
- Customise the insert front cover
- Store additional documents in the half pocket inside the back cover
- Colour code your files and documents
- Made from durable polypropylene



Transparent Document Wallets

- Hook and loop fastener to secure documents
- Made from durable polypropylene
- Lightweight and hard wearing so you don't have to worry about your contents being damaged

Code	Colour	Description	Size
49020	Black	Holds 50 Sheets	A4

Code	Colour	Description	Size
47770	Blue	Hook & Loop Fastener	Foolscap
47771	Clear	Hook & Loop Fastener	Foolscap



Plastic Wallet & Binder

- Multi-punched filing strip to suit all 2, 3 and 4 ring binders
- Hook and loop fastener to secure documents
- Made from durable polypropylene

Code	Colour	Description	Size
47900 BEST SELLER	Clear	<input type="checkbox"/> 11 Hole Punch	A4



Clear Zip Document Pouch

- Zip closure secures and protects contents
- Made from durable polypropylene
- Expands to 30mm

Code	Colour	Description	Size
47728	Clear	<input type="checkbox"/> Zip	A4



Assorted Colour Lock Files

- Includes one file of each colour – purple, green, red, blue and orange
- Allows papers to be secured without the need for hole punching
- Innovative corner lock prevents pages from falling out
- Manufactured from durable polypropylene

Code	Colour	Description	Size
68020	Assorted	<input type="checkbox"/> <input type="checkbox"/> <input type="checkbox"/> <input type="checkbox"/> <input type="checkbox"/> Holds 20 Sheets	A4



Transparent Project Files

- Reversible colour coded strip
- Flap secure contents
- Durable polypropylene

Code	Colour	Description	Size
47920	Blue	<input checked="" type="checkbox"/> Holds 20 Sheets	A4
47921	Clear	<input type="checkbox"/> Holds 20 Sheets	A4
47922	Green	<input checked="" type="checkbox"/> Holds 20 Sheets	A4
47923	Red	<input checked="" type="checkbox"/> Holds 20 Sheets	A4



Transparent Letter File

- Made from durable polypropylene
- Thumb cut opening for easy access to documents

Code	Colour	Description	Size
47941	Clear	<input type="checkbox"/> Holds 20 Sheets	A4

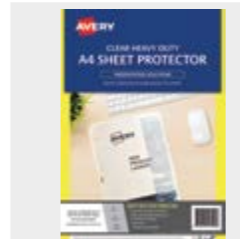

Sheet Protectors

- Ideal for school or office
- Folder-friendly – fits all 2, 3 and 4 ring binders
- Made from durable polypropylene

Code	Colour	Description	Size
47901	Clear	<input type="checkbox"/> Sheet Protector Heavy Duty	A4
47902	Clear	<input type="checkbox"/> Expandable Pocket 30mm, 11 hole punch	A4

Tags



We have the tag for you!

Browse through our range of shipping, coloured and merchandise Tags for any project big or small.

Buff Tags

- For easy identification
- Manufactured from quality manilla board
- Reinforced holes for durability
- Supplied in bundles of 4 slightly connected tags that separate easily
- Use for craft projects, gift tags and warehousing

Code	Colour	Descr.	Size	Tag Per Box
Small Packs				
11100	Buff	Size 1	70 x 35mm	10
13100	Buff	Size 3	96 x 48mm	10
14100	Buff	Size 4	108 x 54mm	10
15100	Buff	Size 5	120 x 60mm	10
Bulk Packs				
11000	Buff	Size 1	70 x 35mm	1000
12000	Buff	Size 2	82 x 41mm	1000
13000	Buff	Size 3	96 x 48mm	1000
14000	Buff	Size 4	108 x 54mm	1000
15000	Buff	Size 5	120 x 60mm	1000
16000	Buff	Size 6	134 x 67mm	1000
17000	Buff	Size 7	146 x 73mm	1000
18000	Buff	Size 8	160 x 80mm	1000

Coloured Tags

- For easy identification
- Manufactured from quality manilla board
- Reinforced holes for durability
- Supplied in bundles of 4 slightly connected tags that separate easily
- Use for craft projects, gift tags and warehousing

Code	Colour	Descr.	Size	Tag Per Box
14551	Red	Size 4	108 x 54mm	50
14552	Blue	Size 4	108 x 54mm	50
14556	White	Size 4	108 x 54mm	50
14110	Red	Size 4	108 x 54mm	1000
14120	Blue	Size 4	108 x 54mm	1000
14130	Green	Size 4	108 x 54mm	1000
14140	Yellow	Size 4	108 x 54mm	1000
14150	Pink	Size 4	108 x 54mm	1000
14160	White	Size 4	108 x 54mm	1000
15110	Red	Size 5	120 x 60mm	1000
15120	Blue	Size 5	120 x 60mm	1000
15130	Green	Size 5	120 x 60mm	1000
15140	Yellow	Size 5	120 x 60mm	1000
16110	Red	Size 6	134 x 67mm	1000
16120	Blue	Size 6	134 x 67mm	1000
16130	Green	Size 6	134 x 67mm	1000
16140	Yellow	Size 6	134 x 67mm	1000
16160	White	Size 6	134 x 67mm	1000
18110	Red	Size 8	160 x 80mm	1000
18120	Blue	Size 8	160 x 80mm	1000
18130	Green	Size 8	160 x 80mm	1000
18140	Yellow	Size 8	160 x 80mm	1000
18160	White	Size 8	160 x 80mm	1000
18170	Orange	Size 8	160 x 80mm	1000







Merchandise Tags with String

- Ideal for retail point-of-sale, markets and garage sales
- Perfect alternative to adhesive labels that may not be suitable for some merchandise items
- Reinforced holes for durability
- Made from high quality, heavy gauge white board and strung with twine, knotted at one end for easy attachment
- Use for small and fiddly items that require a smaller tag







Code	Colour	Description	Size	Tags per Box
993621	White	Size 21AH	21 x 13mm	1000
993623	White	Size 23H	30 x 21mm	1000
993624	White	Size 24H	37 x 23mm	1000
993626	White	Size 26H	47 x 30mm	1000



Classic Tags Laser / Inkjet

- Classic shaped tags made from heavyweight matt cardstock provides an optimal base for vivid graphics and sharp text
- Ability to print double-sided to allow more room for your logo, messaging, pricing or barcode
- Create unique tag designs using Avery Design & Print software, also compatible with Microsoft® Word Templates
- Suitable for laser and inkjet printers







Code	Software Code	Description	Size	GSM	Tags per Sheet	Tags per Pack
982505	C32303	Matt White	89 x 51mm	220gsm	10	50



Scallop Tags Inkjet

- Decorative scallop shaped tags made from heavyweight matt cardstock provides an optimal base for vivid graphics and sharp text
- Ability to print double-sided to allow more room for your logo, messaging, pricing or barcode
- Create unique tag designs using Avery Design & Print software, also compatible with Microsoft® Word Templates
- Suitable for inkjet printers





Code	Software Code	Description	Size	GSM	Tags per Sheet	Tags per Pack
980050	22848	Matt White	50 x 32mm	216gsm	18	90



Tags with String

- Classic tag shape perfect for any project
- Reinforced hole keeps tag attached without tearing
- Durable white paper twine to compliment the white reinforced eyelet
- Supplied in a convenient 24 pack perfect for any project
- Ideal for gifting, art & craft projects, weddings & events

Code	Colour	Size	Tags per Pack
13200	Kraft Brown	96 x 48mm	24
13201	Pastel Pink	96 x 48mm	24
13202	Pastel Blue	96 x 48mm	24
13203	Pastel Green	96 x 48mm	24
13204	Pastel Peach	96 x 48mm	24
13205	Pastel Yellow	96 x 48mm	24





Multi Coloured Tags

- An assortment of bright colours includes orange, yellow, green, red and blue
- Reinforced hole keeps tag attached without tearing
- Durable white paper twine to compliment the white reinforced eyelet
- Supplied in a convenient 24 pack perfect for any project
- Ideal for gifting, art & craft projects, weddings & events

Code	Colour	Size	Tag Per Pack
13206	Bright Multi-Colour	96 x 48mm	24
13207	Pastel Multi-Colour	96 x 48mm	24



Scallop Tags

- Decorative scalloped design
- Premium metallic gold reinforced eyelet
- Durable black paper twine to compliment the tag
- Supplied in a convenient 25 pack perfect for any project
- Ideal for gifting, art & craft projects, weddings & events

Code	Colour	Size	Tag Per Pack
13208	Black	85 x 45mm	25
13209	White	85 x 45mm	25
13210	Kraft Brown	85 x 45mm	25

Multi Coloured Tags



Scallop Tags



Food Rotation Labels



Food rotation labels are an essential part of any busy kitchen.

Organise and identify food according to best practice stock rotation methods with Avery's pre-printed and colour-coded fridge and pantry storage labels.



Day Labels Round Removable

- Write the date on the white section of the label
- Visibly identifies discard date of prepared food
- Ideal for refrigeration and food storage applications
- Temperature -5°C to +60°C

Code	Description	Colour	Size	Labels per Roll
937329	Monday	White printed Blue	24mm diameter	1000
937330	Tuesday	White printed Yellow	24mm diameter	1000
937331	Wednesday	White printed Red	24mm diameter	1000
937332	Thursday	White printed Brown	24mm diameter	1000
937333	Friday	White printed Green	24mm diameter	1000
937334	Saturday	White printed Orange	24mm diameter	1000
937335	Sunday	White printed Black	24mm diameter	1000



Day Labels Square Removable

- Write the date on the white section of the label
- Visibly identifies discard date of prepared food
- Ideal for refrigeration and food storage applications
- Temperature -5°C to +60°C

Code	Description	Colour	Size	Labels per Roll
937336	Monday	White printed Blue	40 x 40mm	500
937337	Tuesday	White printed Yellow	40 x 40mm	500
937338	Wednesday	White printed Red	40 x 40mm	500
937339	Thursday	White Printed Brown	40 x 40mm	500
937340	Friday	White printed Green	40 x 40mm	500
937341	Saturday	White printed Orange	40 x 40mm	500
937342	Sunday	White printed Black	40 x 40mm	500



Preparation Label Removable

- Streamline food preparation and rotate food supplies to ensure you are serving the correct foods first
- Visibly identifies discard date of prepared food
- Ideal for refrigeration and food storage applications
- Temperature -5°C to +60°C

Code	Description	Colour	Size	Labels per Roll
937343	Use First Label	Yellow printed Black	40mm	500
937344	Use By Label	Printed Red	40mm	500



Shelf Life Labels Removable

- Write the date on the white section of the label
- Use in conjunction with Day Labels
- Visually identifies discard date of prepared food
- Ideal for refrigeration and food storage applications
- Temperature -5°C to +60°C

Code	Description	Colour	Size	Labels per Roll
937345	Shelf Life Label	White Printed Black	102 x 47mm	500



Day Labels Dispenser Kit

- This kit provides a complete solution for your Day Label requirements
- Contains a plastic dispenser and one of each Day Labels 24mm Round Monday to Sunday
- Each Day Label roll is on a core and easily feeds through the dispenser
- Convenient and perfectly organised for a productive kitchen environment

Code	Description	Colour	Size	Labels per Roll
937348	Kit includes 1 x roll of each day plus dispenser	Various	24mm	500



Day Labels Dispenser

- Provides an ideal solution to store your Day Labels 24mm Round
- Labels are readily accessible for use when required
- Keeps everything at hand and organised in a productive kitchen
- 24mm Round Day Labels not included

Code	Description	Colour	Size
937347	Day Labels Dispenser	White	W273mm x D159mm x H70mm

Allergy Labels

- Providing peace of mind for staff arranging food preparation and packaged meals to lessen the risk of using or serving food or beverages with certain allergens to their customers, employees or patients.
- Ideal for use in commercial kitchens for hospitality, healthcare, education or any other industries where food is prepared and served for a large amount of people.
- It is ideal for use on containers including plastics and glass. Please remove label prior to placing container in dishwasher.
- No matter what your food & beverage safety requirements are – Avery has got you covered!
- Temperature -5°C to +60°C

Code	Description	Colour	Size	Labels per Roll
937361	Dairy Free Labels	White Printed Red/Blue	40mm	500
937362	Egg Free Labels	White Printed Red/Blue	40mm	500
937363	Tree Nut Free Labels	White Printed Red/Blue	40mm	500
937364	Peanut Free Labels	White Printed Red/Blue	40mm	500
937365	Shellfish Free Labels	White Printed Red/Blue	40mm	500
937366	Wheat Free Labels	White Printed Red/Blue	40mm	500
937367	Soy Free Labels	White Printed Red/Blue	40mm	500
937368	Gluten Free Labels	White Printed Red/Blue	40mm	500



Avery Term	Definition
Antimicrobial Film	Transparent self-adhesive film that can be used on high touch surfaces to help reduce the spread of some germs.
Avery Design & Print Online	Using Avery Design & Print Online, you can add text, messages, images, and logos to any template and instantly print to create your perfect design. Start with a blank label and take full creative license, or tweak one of our many pre-designed templates to suit your needs.
Easy Apply™ Strips	Save time with the Easy Apply™ strips that let you print and apply all the tab labels at once onto the tabs rather than sticking them on one-by-one, making it simple to create custom dividers right from your desktop for a professional finish.
FSC® Certified	FSC® certification assures the consumer the product materials were sourced from responsibly managed forests. When you see an FSC® logo on a product you can buy with the confidence that you are helping to ensure our forests are alive for generations to come.
Jam Free Guarantee	The Avery Jam Free guarantee means that your product is produced and formatted in a way that prevents adhesives bleeding into your printer. This will give you peace of mind by ensuring no printer jams due to adhesive build up.
Mail Merge	A process which takes data from one source and applies it to another. By using Avery's Import Data feature you can rearrange information into a new format at the touch of a few buttons. Mail merging is perfect for producing address labels, invitations and mass mailings, and Avery's free Design & Print software includes this feature within it.
Mylar Dividers	Mylar dividers have reinforced holes and tabs for extra strength so you can use them time and time again. In addition, they are available in various tab formats, including numbered, lettered and plain tabs which are brightly coloured for easy identification.
NoPeel™ Labels	If an attempt has been made to remove the label the material flakes and disintegrates, making removal virtually impossible and tampering immediately visible.
Print & Divide	A perforated backing card for individual separation of the name badges, these can be sorted into sections before application and when required your attendees can apply their own badge themselves.
Print-to-the-edge	Gives you the ability to add a full-colour background to your labels to make your products really stand out and look professional.
Permanent Labels	Avery permanent labels can be trusted to stay exactly where you left them, every time you need them. The permanent adhesive keeps the label securely in place making it ideal for parcels, branding, gifts or other applications where a label is carrying important information.
Pre-Printed Tabs	Pre-Printed Tabs mean your dividers are instantly ready to go. Numbers, letters, or months will give you an immediate system to help you to organise your filing.
Printable on both sides	For products that won't be stuck down, why not present your creative designs on both sides to really show off. Create and print text and designs on both sides to spread your message in a more dimensional way.
Quick & Clean	Avery Quick & Clean technology allows you to easily remove your product business cards from the sheet, leaving a completely straight and clean edge to give your business that professional image.
Quick Peel™ Labels	The unique QuickPeel™ feature allows labels to be easily taken from the sheet by removing a strip of the backing paper, revealing the edge of each label. You will never have to go through the pain of picking away at the corner of a label again!
Removable Labels	Perfect for your short term labelling requirements. They are easy to peel and apply and the removable adhesive sticks to glass, plastic and paper and when removed, no sticky residue is left behind.
Rewritable Labels	Avery Rewritable Labels are made from dry erase material, which means they are rewritable and removable making them perfect for temporary or permanent identification. Just wipe clean and rewrite when needed with a dry erase marker to easily update the label.

Avery Term	Definition
Self-Laminating Labels	Self-laminating labels will survive the harsh environments of both the dishwasher and the freezer. Identify lunchboxes or food storage boxes and be confident your labels will stay put. The self-laminating feature protects your writing and helps keep the label surface clean and protected. Just write, seal and stick.
Smooth Feed	High volume label users need labels designed for speed and high volume use. Avery Address Label with Smooth Feed are for frequent printing of labels for letters and envelopes, and are developed for high volume, high speed printers. The unique Avery Smooth Feed Edges and Jam-Free™ promise mean flawless high speed printing, even in high speed printers and copiers. That means faster, easier mailing!
Smudge Free Labels	Print and use straight away with Smudge Free Labels. Ink dries instantly to avoid smudging when handling and applying your labels, saving you time.
Surefeed®	Sure Feed technology helps to minimise waste and inefficiency during your printing by ensuring a reliable feed and accurate print alignment.
Style Edge™	A fun, stylish way to divide papers in your binder or planner, Style Edge™ tabs offer a unique oval design with a modern look and 5 fresh colours to help make the tabs stand out. They also have a clever notch feature which prevents your title inserts from falling out.
Thermal Roll Labels	Thermal Roll Labels are ideal for use in warehousing and facilities for creating and printing product and inventory labels for quick and easy identification.
TripleBond™ Labels	Provides three times stronger adhesion than a standard paper label.
TrueBlock Labels	Avery Trueblock® technology creates a completely opaque barrier to hide what's underneath your label, whether it's an old label from pre-used packaging or a pattern on the box. Blockout will allow you to re-use that old box or envelope and make it look new.
Ultra-Resistant Labels	Resistant to Chemicals, UV and saltwater. Engineered for harsh environments.
Water Resistant labels	Tough, durable labels which withstand outdoor environments.
Weatherproof	Weatherproof Labels stand up to tough weather and temperature conditions and resist scuffs, tears and smudges so they remain easy to read.

Avery's commitment to sustainability



OUR COMMITMENT TO MAKING A DIFFERENCE

At Avery we are committed to responsible and sustainable business practices by being FSC® Certified.

By choosing Avery you can be assured that we are working to improve the way we source our products and the future of our planet.



FSC is dedicated to the promotion of responsible forest management worldwide. The FSC label means that materials used for the product have been responsibly sourced.



averyaunz

averyproducts.com.au

Avery Products Australia
11 Carrington Road, Castle Hill, NSW 2154
Australia: 1800 644 353 | New Zealand: 0800 228 379

© 2022 Avery Products Pty Ltd. All rights reserved