

## 2018 - 2019 Product Catalogue

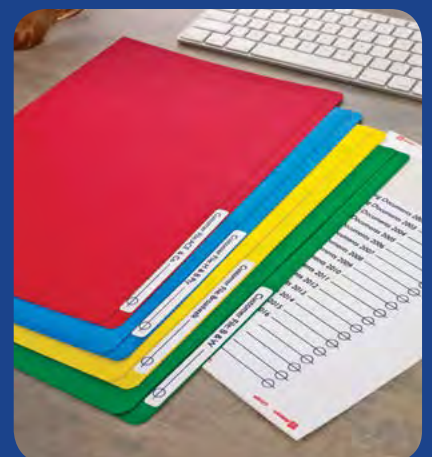

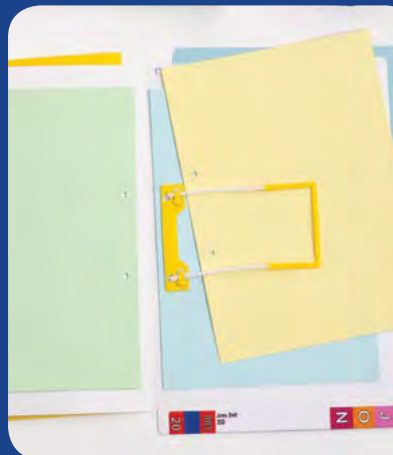

Did you know?

Avery has FREE easy-to-use template software to customise your labels. Simply go to Avery Design & Print [averyproducts.com.au/print](http://averyproducts.com.au/print) to start designing.



[averyproducts.com.au/print](http://averyproducts.com.au/print)



Introduction to Avery Materials	2
Labels Size Guide	4
Other Shapes Guide	9

<b>Labels</b>	
Address Labels	11
Parcel & Shipping Labels	15
High Visibility Labels	19
Clear Labels	20
Filing Labels	21
Matt & Gloss Labels	22
Multi-Purpose Labels	23
Round & Oval Labels	25
Coloured Labels	27
Dispenser Labels	28
Dot Matrix & Roll	
Address labels	31
Blister Pack Labels	32
Unistat & TRIM Labels	34
Avery General Use Labels	35

<b>Conference &amp; Events</b>	
Name Badge Labels	37
Card Products	39
Product Labels	40
Cling Sheets	41

<b>Industrial Grade</b>	
Identification Labels	43
Security Labels	47
Cable Markers	47
Warehouse Labels	49

<b>Food Rotation Labels</b>	
Labels	51
Dispenser	52
Freezer Labels	52
Coloured Circles	53

<b>Small Business Branding Solutions</b>	
Labels	54
Retail Solutions	60
Business Cards	62

<b>Home Organisation</b>	
Organisation & Storage Labels	65
Magnets	67
Self Laminating Labels	68
Clothing Labels	69
T-Shirt Transfers	69

<b>Celebrations &amp; Parties</b>	
Labels	71
Card Products	72
Address Labels	73

<b>Merits, Ribbons &amp; Certificates</b>	
Stickers	76
Kids Labels	77
Ribbons	78
Certificates	78

<b>Filing &amp; Dividers</b>	
Manilla Files	80
Files with Fasteners	82
Fasteners	85
Print and Apply Dividers	87
Pre-Printed Dividers	89
Manilla Board Dividers	92

<b>Lateral Filing</b>	
Files & Wallets	94
Packages & Kits	100
Racks	102
Software	103
Labels	103
Cabinets	110

<b>Presentation Filing</b>	
Pouches & Display Books	114
Document Files & Wallets	115
Accessories	118

<b>Tags</b>	
Buff & Coloured	120
Printable Tags	121
Merchandise Tags	121
Tags with String	121

<b>Avery Terminology</b>	124
--------------------------	-----

## GENERAL PURPOSE LABELS

Avery labels are designed with superior adhesive and premium material for use in any labelling project.



### Crystal Clear

Made from a gloss transparent PET film with toner receptive top coating, making these labels dirt and tear-resistant. Crystal Clear Labels are unaffected by temperature variations from -20°C to +80°C and the permanent adhesive permits use on glass, plastic, metal and paper.

LASER COMPATIBLE



### Enviro

Label material made from white uncoated paper from 100% recycled fibres so you can be sure you are doing your bit to help the environment. Enviro Labels are unaffected by temperature variations -20°C to +100°C and are made with water soluble adhesive.

LASER COMPATIBLE



### Frosted Clear

Made from Clear PET Film, these Frosted Clear labels are unaffected by temperature variations -53°C to +93°C. Ideal for adding elegance to dark coloured and patterned envelopes especially for use at corporate events and for wedding invitations.

INKJET COMPATIBLE



### Gloss

Made from special coated gloss finished paper, Gloss Labels are unaffected by temperature variations -20°C to +100°C. The permanent adhesive on these labels permits use on glass, metal, plastic and paper surfaces.

LASER/INKJET COMPATIBLE



### Matt

Made from special coated matt white woodfree printing paper with a smooth, microporous surface structure. Matt Labels are unaffected by temperature variations from -20°C to +80°C and are made with permanent acrylic based adhesive which permits use to glass, plastic and paper surfaces.

LASER/INKJET COMPATIBLE



### Removable

Made from woodfree machine finished paper, Removable Labels are unaffected by temperature variations -10°C to +70°C. The general purpose removable adhesive adheres securely to any smooth surface and can be easily removed when needed, making them ideal for temporary identification.

LASER/INKJET COMPATIBLE



### Trueblock®

Featuring a unique opaque silver backing that completely covers up existing labels or previous information on parcels or boxes. Trueblock® Labels are unaffected by temperature variations -40°C to +149°C.

LASER/INKJET COMPATIBLE

## INDUSTRIAL GRADE SOLUTIONS

Avery Industrial grade labels are engineered to withstand harsh environments that a standard paper label can't endure.



### White Heavy Duty

Made from polyester material they are oil, dirt and water resistant and tear-proof. White Heavy Duty Labels are unaffected by temperature variations from -20°C to +80°C and the permanent adhesive permits use to metal, plastic, painted surfaces, polycarbonate and glass.

INKJET COMPATIBLE

LASER COMPATIBLE



### NoPeel™

Made from acrylic they are oil, dirt and water resistant and tear-proof. NoPeel™ Labels are unaffected by temperature variations -40°C to +100°C and the permanent adhesion permits use to laptops, tablets, mobiles, computers, computer screens and office equipment. These tamper-evident security labels are permanent and are designed not to peel off. If an attempt has been made to remove the label, the material flakes and disintegrates, making removal virtually impossible and tampering immediately obvious.

LASER COMPATIBLE



### Heavy Duty Removable

Made from polyester material they are oil, dirt and weather resistant as well as tear-proof. These Removable Labels are unaffected by temperature variations -20°C to +80°C and are ideal for creating temporary labelling of equipment, facilities and storage supplies, stock take and organising workshops.

LASER COMPATIBLE

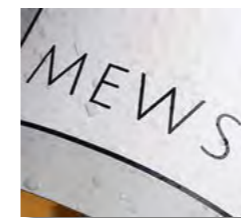

### TripleBond™

Made from polyester material they are oil, dirt and water resistant and tear-proof. TripleBond™ Labels are unaffected by temperature variations from -40°C to +100°C and the permanent adhesion permits use to metal and plastic even if the surface is difficult e.g. hot, cold or rough.

LASER COMPATIBLE



### Silver Heavy Duty

Made from polyester material they are oil, dirt and water resistant and tear-proof. Silver Heavy Duty Labels are unaffected by temperature variations from -40°C to +150°C and the permanent adhesive permits use to metal, plastic, painted surfaces, polycarbonate and glass.

LASER COMPATIBLE



### Ultra-Resistant Outdoor

Made from a polyethylene film with a strong adhesion they are resistant to UV, weather, saltwater and chemicals. Ultra-Resistant Outdoor Labels are unaffected by temperature variations -40°C to +150°C and the strong adhesion permits use to metal, plastic, painted surfaces, polycarbonate and glass.

LASER COMPATIBLE

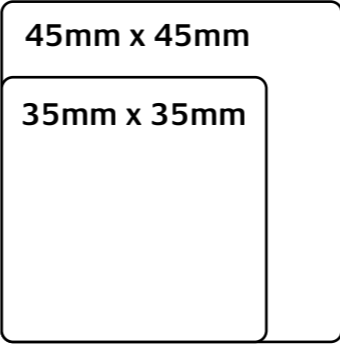
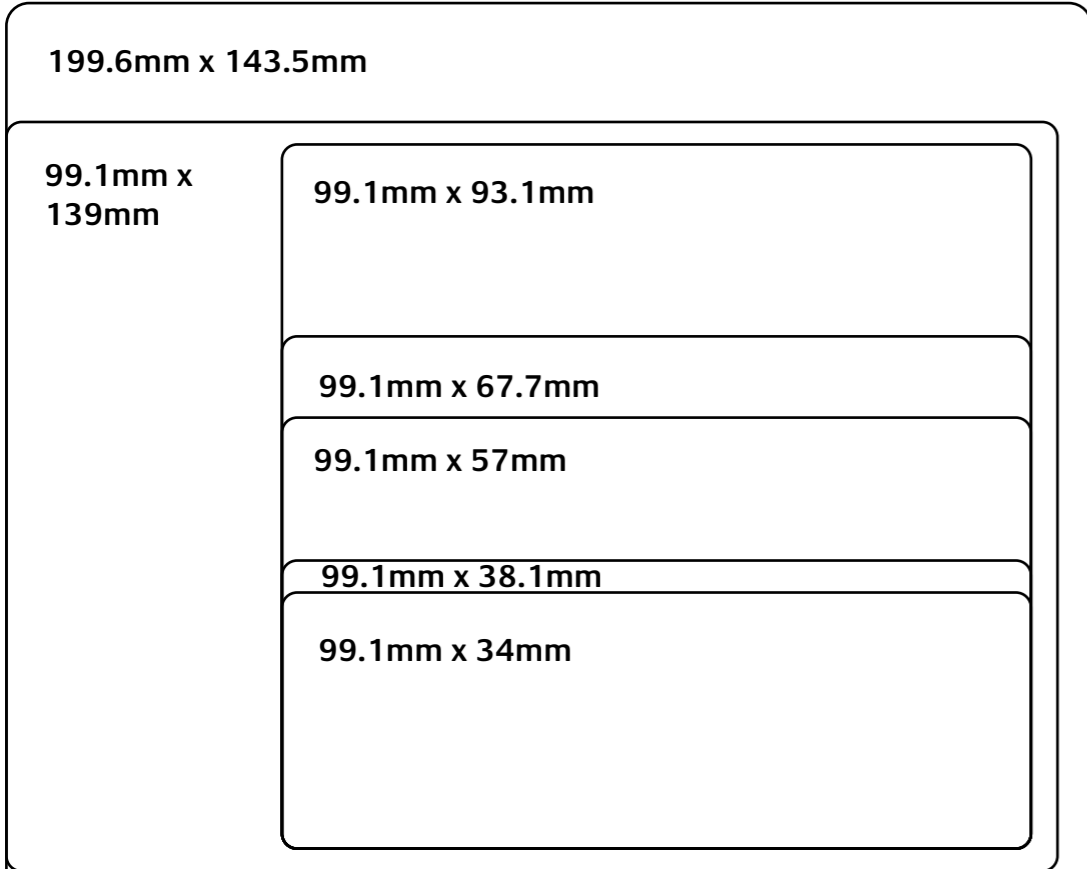

2 large size:  
197.6mm x 289.1mm  
208mm x 295mm  
not shown.

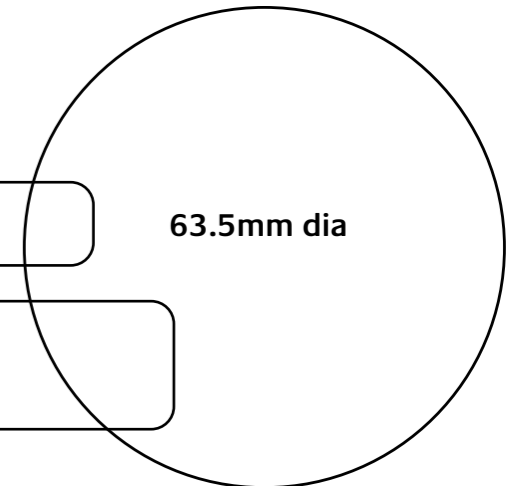
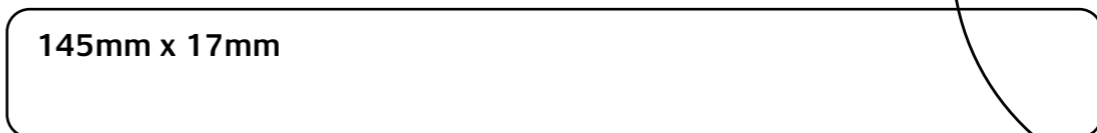
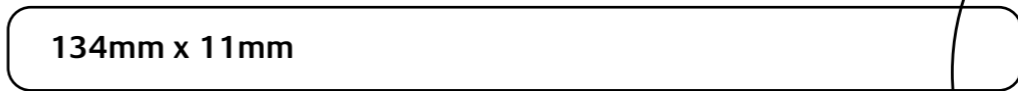
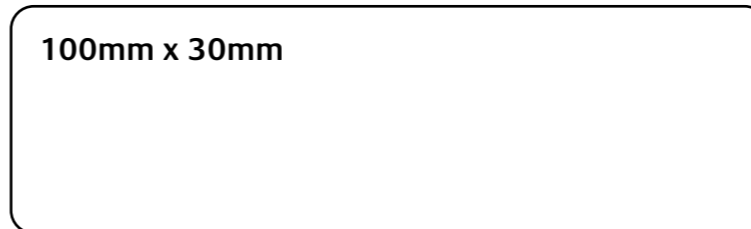
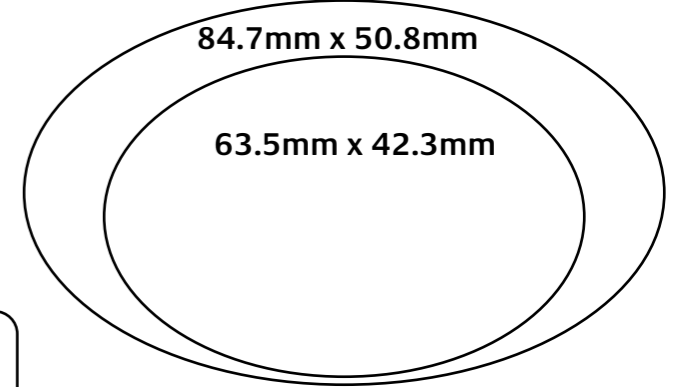
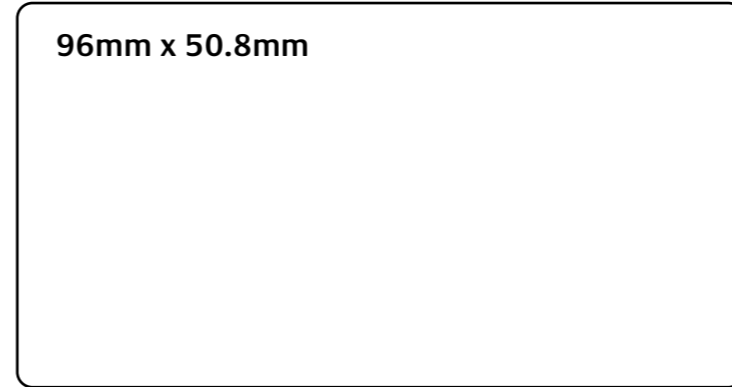
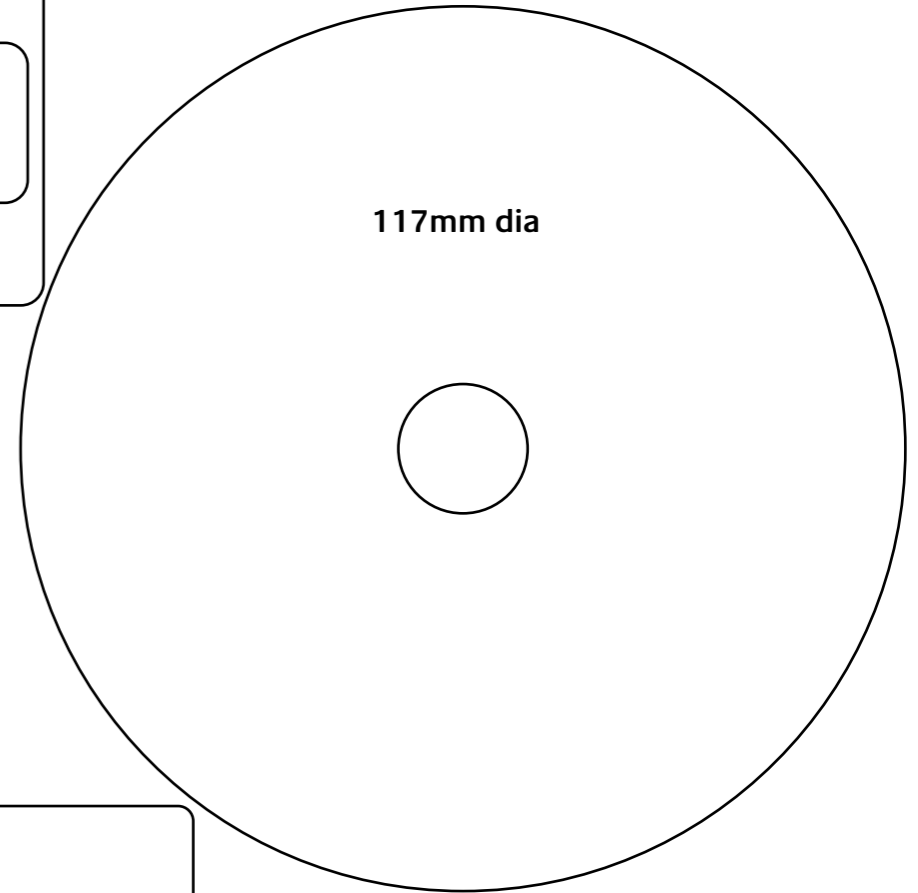
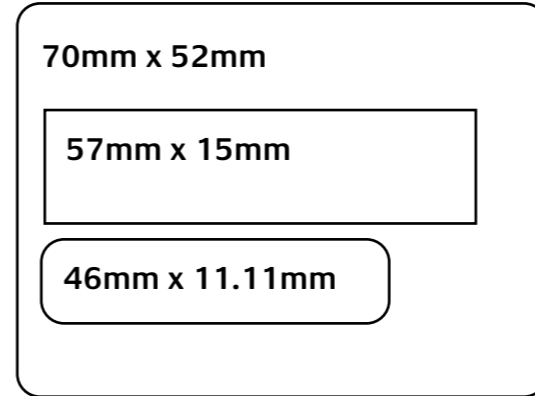
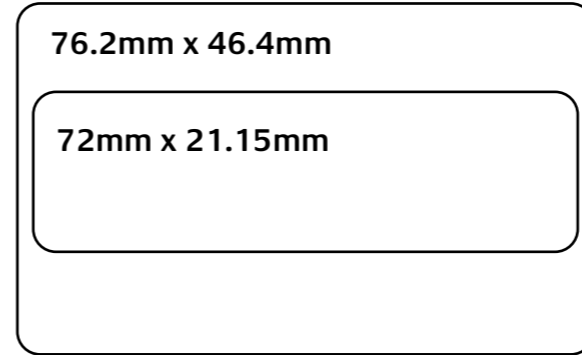
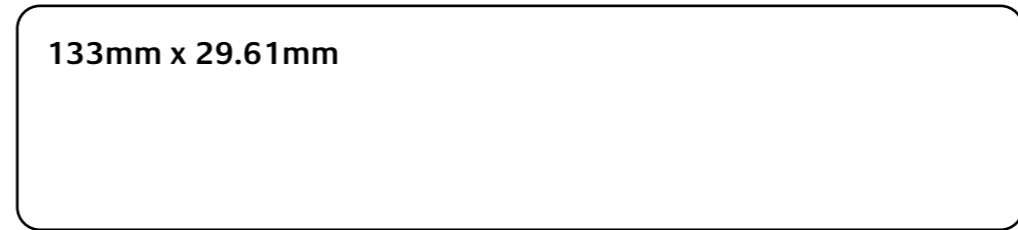
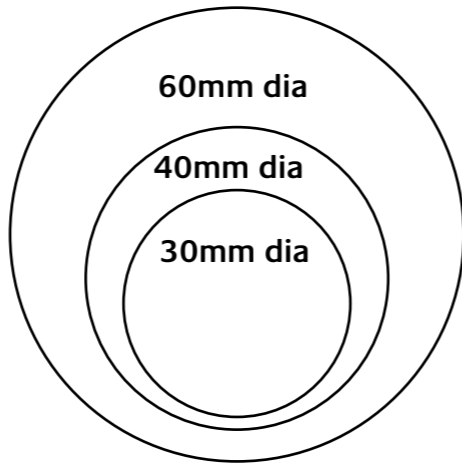
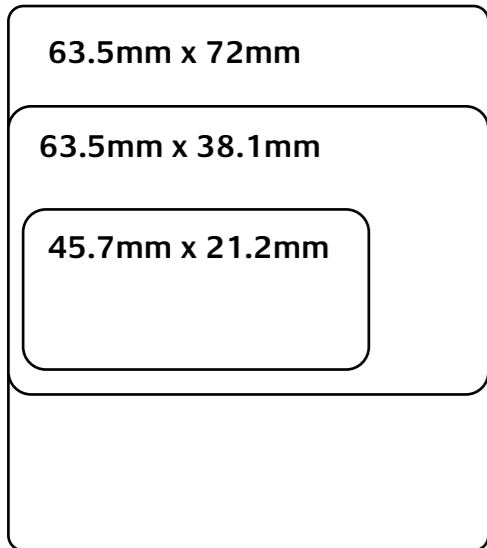
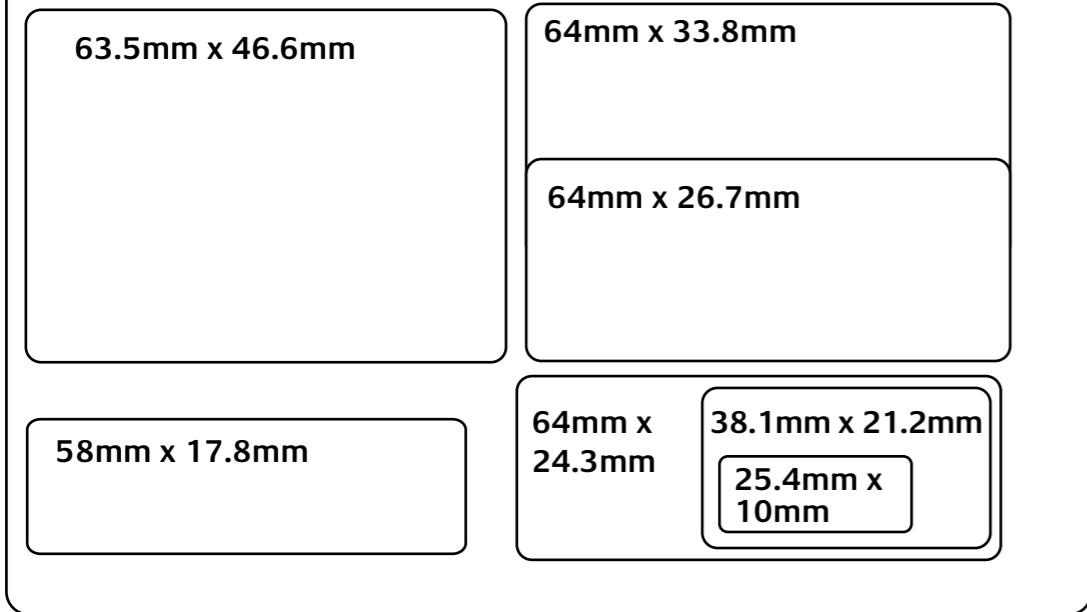

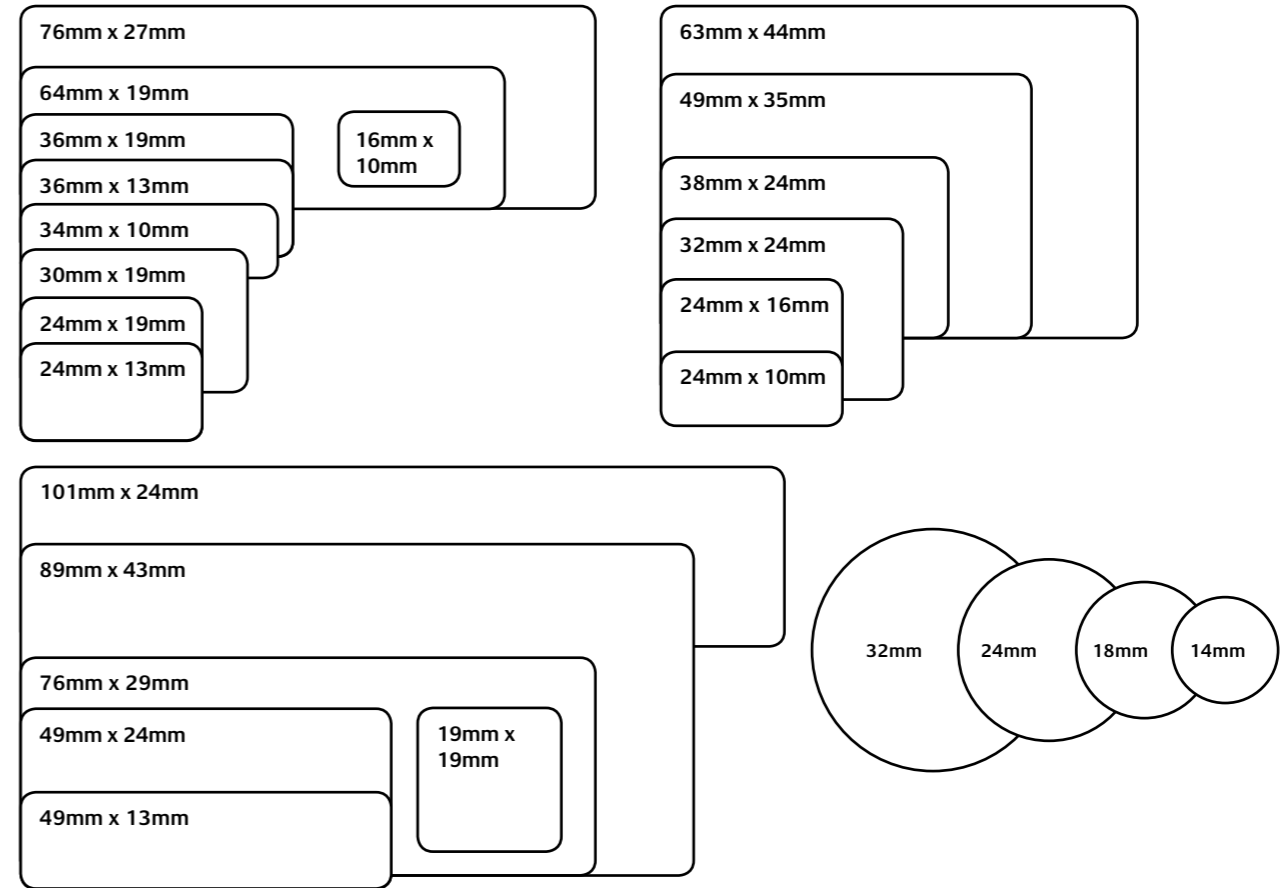
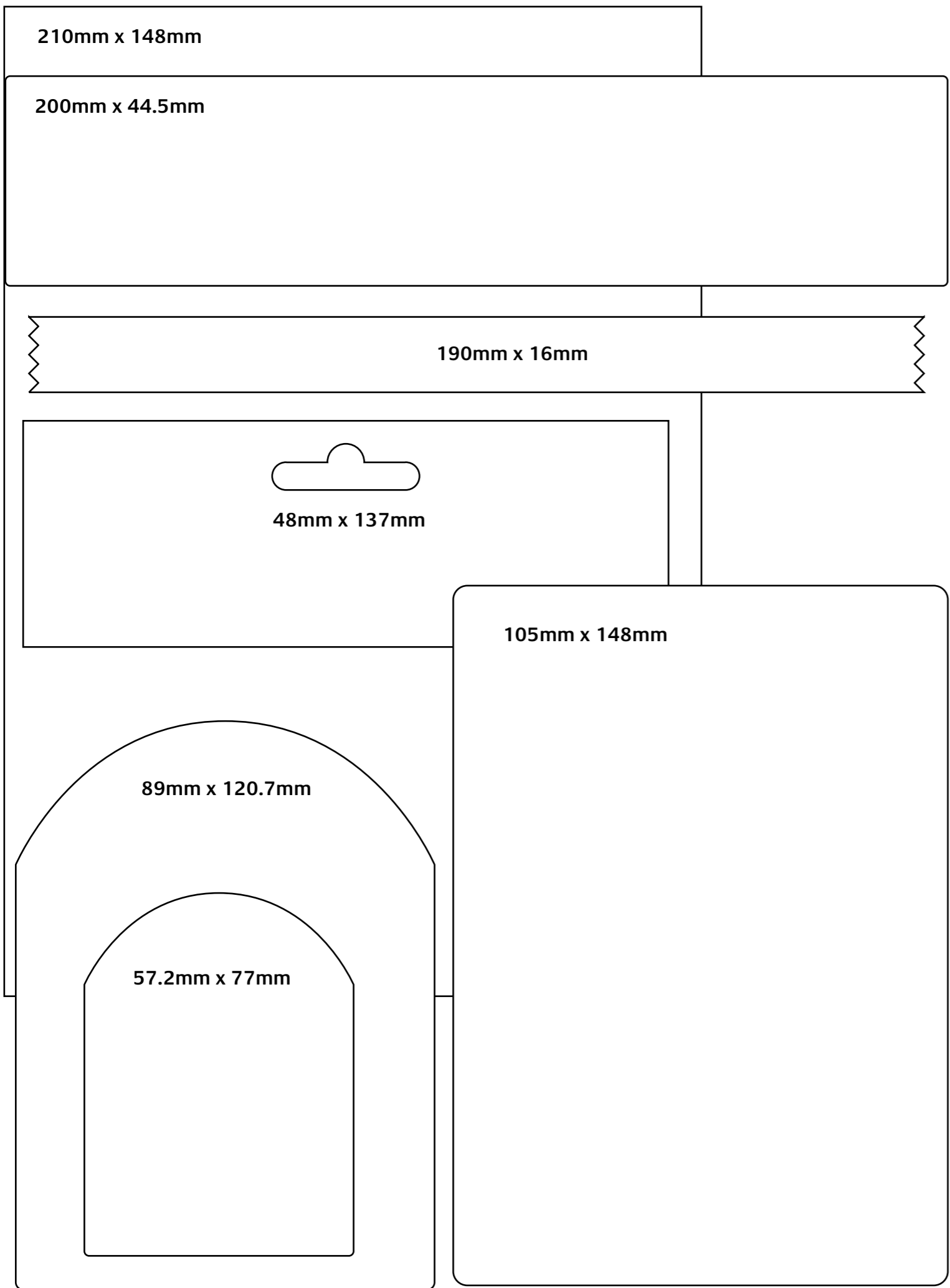

Sticker Size Guide

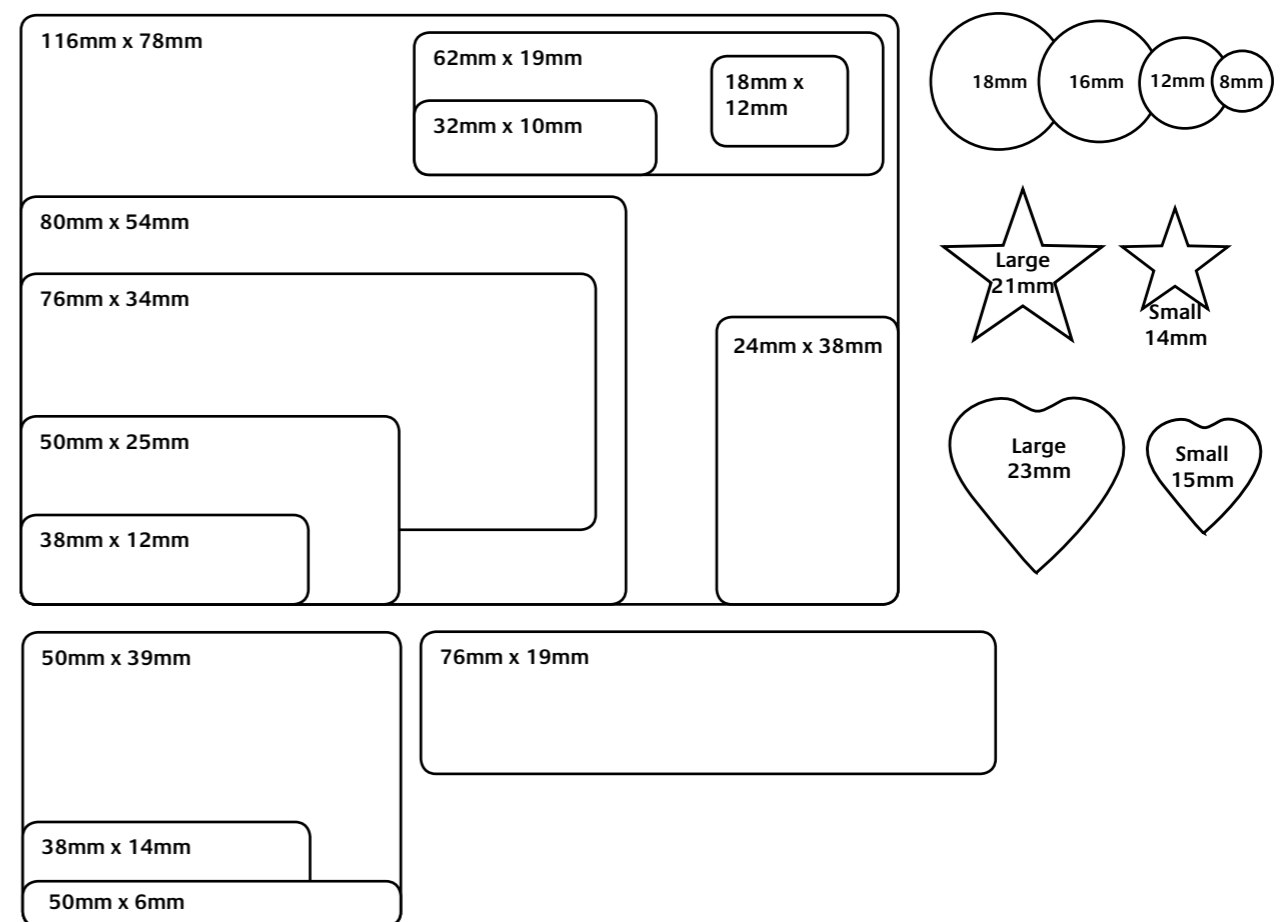

200.7mm x 93.1mm

200mm x 60mm

196mm x 51mm

99.1mm x 42.3mm

80mm x 35mm

45.7mm x 25.4mm

182mm x 130mm

62mm x 89mm

62mm x 42mm

96mm x 51mm

94mm x 32mm

57.2mm x 25.4mm

63.5mm x 33.9mm

63.5mm x 24mm

64mm x 30.5mm

63.5mm x 29.6mm

### Other Shapes Guide

The shapes listed are all printable A4 sheet labels.

Code	Product Name	Colour	Size	Labels per Sheet	Sheets per Pack	Page
<b>Round</b>						
959206	Heavy Duty Removable Labels	White	30 mm diameter	48	20	46
910007	Removable Round Labels	White	40 mm diameter	24	8	61
959146	Round Multi-purpose Labels	White	40 mm diameter	24	10	25
959162	White Heavy Duty Labels	White	40 mm diameter	24	10	43
959164	Crystal Clear Round Multi-purpose Labels	Crystal Clear	40 mm diameter	24	10	25
959166	Frosted Clear Round Multi-purpose Labels	Frosted Clear	40 mm diameter	24	10	25
980052	Glossy Round Labels	White	40 mm diameter	24	10	55
980001	Glossy Round Labels	White	60 mm diameter	12	10	55
980002	Kraft Brown Round Labels	Kraft Brown	60 mm diameter	12	15	57
980009	Removable Round Labels	White	60 mm diameter	12	10	58
980022	Crystal Clear Round Labels	Crystal Clear	60 mm diameter	12	10	58
980028	Glossy Round Labels	White	60 mm diameter	12	10	40
980029	Kraft Brown Round Labels	Kraft Brown	60 mm diameter	12	15	40
980030	Crystal Clear Round Labels	Crystal Clear	60 mm diameter	12	10	40
982506	Glossy Round Labels	White	60 mm diameter	12	5	71
982508	Kraft Brown Round Labels	Kraft Brown	60 mm diameter	12	5	74
959145	Round Multi-purpose Labels	White	63.5 mm diameter	12	10	25
960101	White CD Labels	White	117 mm diameter	2	25	23
<b>Oval</b>						
980012	Glossy Oval Labels	White	84.7 x 50.8 mm	8	10	55
980008	Removable Oval Labels	White	63.5 x 42.3 mm	18	10	58
980000	Glossy Oval Labels	White	63.5 x 42.3 mm	18	10	55
980034	Glossy Oval Labels	White	63.5 x 42.3 mm	18	10	40
982507	Glossy Oval Labels	White	63.5 x 42.3 mm	18	5	71
959165	Crystal Clear Oval Multi-purpose Labels	Crystal Clear	63.5 x 42.3 mm	18	10	25
980018	Kraft Brown Oval Labels	Kraft Brown	63.5 x 42.3 mm	18	10	57
980035	Kraft Brown Oval Labels	Kraft Brown	63.5 x 42.3 mm	18	10	40
<b>Square</b>						
980015	Glossy Square Labels	White	35 x 35 mm	35	10	57
980016	Glossy Square Labels	White	45 x 45 mm	20	10	57
980021	Crystal Clear Square Labels	Crystal Clear	45 x 45 mm	20	10	58
980031	Glossy Square Labels	White	45 x 45 mm	20	10	41
980032	Crystal Clear Square Labels	Crystal Clear	45 x 45 mm	20	10	41
982509	Clear Square Labels	Crystal Clear	45 x 45 mm	20	5	71
<b>Arched</b>						
980023	Textured Arched Labels	White	89 x 120.7 mm	4	10	59
980037	Textured Arched Labels	White	89 x 120.7 mm	4	10	40
982510	Textured Arched Labels	White	89 x 120.7 mm	4	5	72
980003	Textured Arched Labels	White	57.2 x 77 mm	9	10	59
980036	Textured Arched Labels	White	57.2 x 77 mm	9	10	40



Well delivered with Avery Labels

Whether you need to send mail out fast or organise your office, we've got the right label for you!

Our comprehensive label range will help save you time at work and at home. With FREE template software available at Avery Design & Print you can design and print your labels with ease.

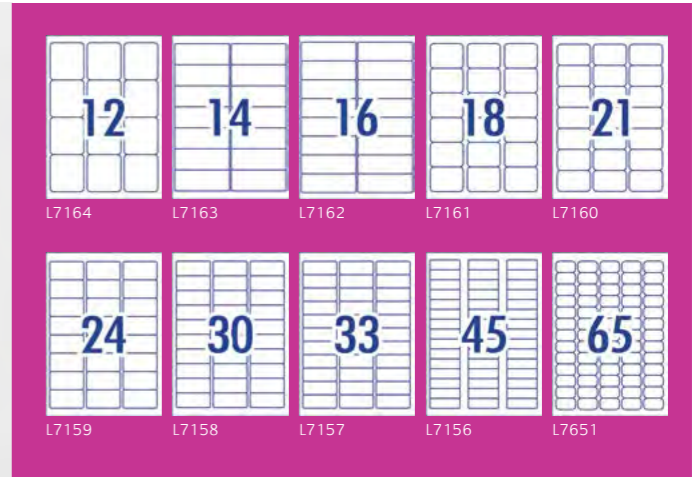

### Address Labels with Quick Peel™ Laser

- Quick Peel™ technology allows for quicker and easier detachment of labels from backing sheet
- Jam-Free™ reliability for trouble free printing on Laser printers, saving time and minimising wastage
- Customise your labels with our free and easy-to-use template software: Avery Design and Print – available at [averyproducts.com.au/print](http://averyproducts.com.au/print)
- Superior adhesive withstands the high heat of laser printers
- FSC® certified labels made with paper from well-managed forests







Code	Software Code	Colour		Size	Labels per Sheet	Sheets per Pack	Labels per Pack
<b>Small Packs</b>							
952003	L7163	White	<input type="checkbox"/>	99.1 x 38.1mm	14	20	280
952002	L7162	White	<input type="checkbox"/>	99.1 x 34mm	16	20	320
952001	L7161	White	<input type="checkbox"/>	63.5 x 46.6mm	18	20	360
952000	L7160	White	<input type="checkbox"/>	63.5 x 38.1mm	21	20	420
959012	L7651	White	<input type="checkbox"/>	38.1 x 21.2mm	65	25	1625
<b>Medium Packs</b>							
959110	L7163	White	<input type="checkbox"/>	99.1 x 38.1mm	14	40	560
959111	L7162	White	<input type="checkbox"/>	99.1 x 34mm	16	40	640
959113	L7159	White	<input type="checkbox"/>	64 x 33.8mm	24	40	960
959115	L7651	White	<input type="checkbox"/>	38.1 x 21.2mm	65	40	2600
<b>Large Packs</b>							
959005	L7164	White	<input type="checkbox"/>	63.5 x 72mm	12	100	1200
959004	L7163	White	<input type="checkbox"/>	99.1 x 38.1mm	14	100	1400
959003	L7162	White	<input type="checkbox"/>	99.1 x 34mm	16	100	1600
959002	L7161	White	<input type="checkbox"/>	63.5 x 46.6mm	18	100	1800
959001	L7160	White	<input type="checkbox"/>	63.5 x 38.1mm	21	100	2100
959029	L7159	White	<input type="checkbox"/>	64 x 33.8mm	24	100	2400
959062	L7158	White	<input type="checkbox"/>	64 x 26.7mm	30	100	3000
959060	L7157	White	<input type="checkbox"/>	64 x 24.3mm	33	100	3300
959061	L7156	White	<input type="checkbox"/>	58 x 17.8mm	45	100	4500
959071	L7651	White	<input type="checkbox"/>	38.1 x 21.2mm	65	100	6500



### Address Labels with Quick Peel™ Inkjet

- Quick Peel™ technology allows for quicker and easier detachment of labels from backing sheet
- Inkjet labels are Smudge-Free™ for a professional finish
- Customise your labels with our free and easy-to-use template software; Avery Design and Print – available at [averyproducts.com.au/print](http://averyproducts.com.au/print)
- Premium quality white labels provided vivid colour and sharp text
- FSC® certified labels made with paper from well-managed forests



Code	Software Code	Colour	Size	Labels per Sheet	Sheets per Pack	Labels per Pack
<b>Small Packs</b>						
936065	J8164	White	63.5 x 72mm	12	25	300
936028	J8163	White	99.1 x 38.1mm	14	25	350
936029	J8162	White	99.1 x 34mm	16	25	400
936031	J8161	White	63.5 x 46.6mm	18	25	450
936032	J8160	White	63.5 x 38.1mm	21	25	525
936054	J8159	White	64 x 33.8mm	24	25	600
936057	J8158	White	64 x 26.7mm	30	25	750
936059	J8157	White	64 x 24.3mm	33	25	825
936060	J8156	White	58 x 17.8mm	45	25	1125
936034	J8651	White	38.1 x 21.2mm	65	25	1625
<b>Large Packs</b>						
936066	J8164	White	63.5 x 72mm	12	50	600
936044	J8163	White	99.1 x 38.1mm	14	50	700
936045	J8162	White	99.1 x 34mm	16	50	800
936046	J8161	White	63.5 x 46.6mm	18	50	900
936047	J8160	White	63.5 x 38.1mm	21	50	1050
936055	J8159	White	64 x 33.8mm	24	50	1200
936056	J8158	White	64 x 26.7mm	30	50	1500
936058	J8157	White	64 x 24.3mm	33	50	1650
936061	J8156	White	58 x 17.8mm	45	50	2250
936049	J8651	White	38.1 x 21.2mm	65	50	3250

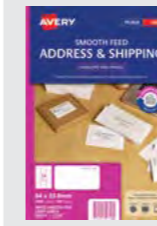

### Address Labels with Smooth Feed Laser

- Smooth Feed Sheet Edges are suited for high speed printers
- Jam-Free™ reliability for trouble free printing on Laser printers, saving time and minimising wastage
- Customise your labels with our free and easy-to-use template software; Avery Design and Print – available at [averyproducts.com.au/print](http://averyproducts.com.au/print)
- Superior adhesive withstands the high heat of laser printers
- FSC® certified labels made with paper from well-managed forests



Code	Software Code	Colour	Size	Labels per Sheet	Sheets per Pack	Labels per Pack
959304	L7163	White	99.1 x 38.1mm	14	100	1400
959329	L7159	White	64 x 33.8mm	24	100	2400
959360	L7157	White	64 x 24.3mm	33	100	3300
959371	L7651	White	38.1 x 21.2mm	65	100	6500
<b>Bulk Packs</b>						
959089	L7163	White	99.1 x 38.1mm	14	250	3500
959090	L7160	White	63.5 x 38.1mm	21	250	5250



*Did you know?* It pays to place the label in the centre of your item and to place the most important information in the centre of the label. Be careful not to crowd this area of the label with too much information.



## TrueBlock® Labels

Opaque backing covers everything underneath for a clean, polished look.

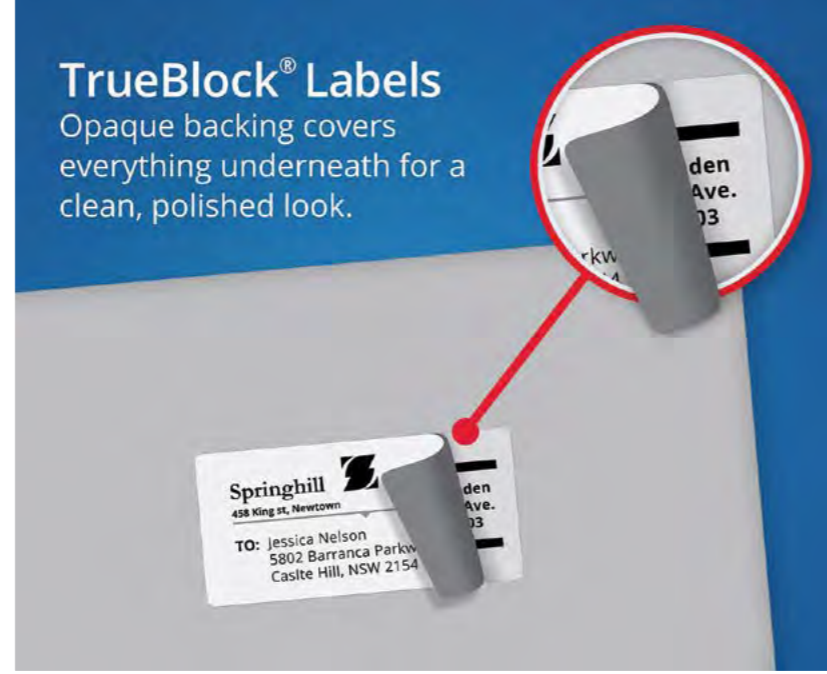

### Parcel / Shipping Labels with Trueblock® Laser

- Trueblock® labels feature an opaque silver backing which completely covers up existing labels or previous information on parcels or boxes
- Jam-Free™ reliability for trouble free printing, saving time and minimising wastage
- Customise your labels with our free and easy-to-use template software; Avery Design and Print – available at [averyproducts.com.au/print](http://averyproducts.com.au/print)
- Ideal for shipping parcels, packages and large gifts
- FSC® certified labels made with paper from well-managed forests

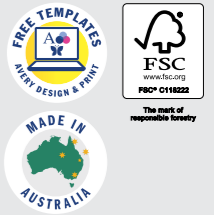

Code	Software Code	Colour	Size	Labels per Sheet	Sheets per Pack	Labels per Pack
<b>Small Packs</b>						
952007	L7167	White	199.6 x 289.1mm	1	20	20
952008	L7168	White	199.6 x 143.5mm	2	25	50
<b>Large Packs</b>						
959009	L7167	White	199.6 x 289.1mm	1	100	100
959008	L7168	White	199.6 x 143.5mm	2	100	200
959013	L7155	White	200.7 x 93.1mm	3	100	300
959030	L7169	White	99.1 x 139mm	4	100	400
959007	L7166	White	99.1 x 93.1mm	6	100	600
959006	L7165	White	99.1 x 67.7mm	8	100	800
959031	L7173	White	99.1 x 57mm	10	100	1000
<b>Bulk Packs</b>						
959091	L7167	White	199.6 x 289.1mm	1	250	250
959092	L7168	White	199.6 x 143.5mm	2	250	500
959093	L7169	White	99.1 x 139mm	4	250	1000
959094	L7165	White	99.1 x 67.7mm	8	250	2000

### Parcel / Shipping Labels with Trueblock® Inkjet

- Trueblock® labels feature an opaque silver backing which completely covers up existing labels or previous information on parcels or boxes
- Ideal for shipping parcels, packages and large gifts
- Customise your labels with our free and easy-to-use template software; Avery Design and Print – available at [averyproducts.com.au/print](http://averyproducts.com.au/print)
- Jam-Free™ reliability for trouble free printing, saving time and minimising wastage
- FSC® certified labels made with paper from well-managed forests

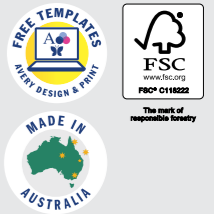

Code	Software Code	Colour	Size	Labels per Sheet	Sheets per Pack	Labels per Pack
<b>Small Packs</b>						
936020	J8167	White	199.6 x 289.1mm	1	25	25
936021	J8168	White	199.6 x 143.5mm	2	25	50
936022	J8169	White	99.1 x 139mm	4	25	100
936023	J8166	White	99.1 x 93.1mm	6	25	150
936024	J8165	White	99.1 x 67.7mm	8	25	200
936063	J8173	White	99.1 x 57mm	10	25	250
<b>Large Packs</b>						
936035	J8167	White	199.6 x 289.1mm	1	50	50
936036	J8168	White	199.6 x 143.5mm	2	50	100
936037	J8169	White	99.1 x 139mm	4	50	200
936038	J8166	White	99.1 x 93.1mm	6	50	300
936039	J8165	White	99.1 x 67.7mm	8	50	400
936064	J8173	White	99.1 x 57mm	10	50	500

### Did you know?

Using emotional imagery or words on labels engages consumers on a primal level and leads to higher interest and greater likelihood of purchase or customer loyalty.

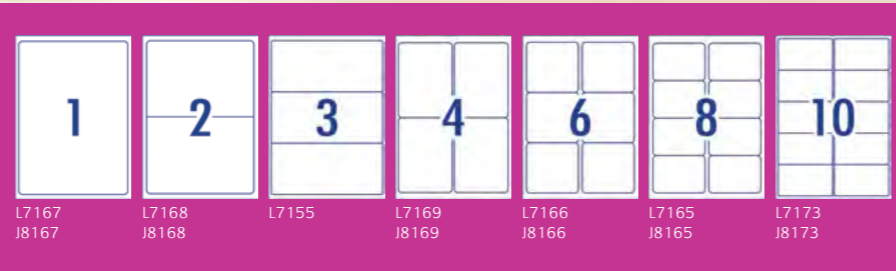

Did you know?

Adding your logo to an address label gives confidence that the package is from a trusted source. Adding icons and images, bold colours and handwritten fonts all proved successful in our label experiments.

Did you know?

Return address labels not only prevent mail from getting lost in the post, it's also another way of reinforcing that the item is from a professional and trusted outlet which helps to encourage recipients to act.



### Internet Shipping Labels with Trueblock® Laser / Inkjet

- Trueblock® labels feature an opaque silver backing which completely covers up existing labels or previous information on parcels or boxes
- Works well with Australia Post, PayPal, eBay and other popular shipping software
- Customise your labels with our free and easy-to-use template software; Avery Design and Print – available at [averyproducts.com.au/print](http://averyproducts.com.au/print)
- Jam-Free™ reliability for trouble free printing, saving time and minimising wastage
- FSC® certified labels made with paper from well-managed forests







Code	Software Code	Colour	Size	Labels per Sheet	Sheets per Pack	Labels per Pack
<b>Small Packs</b>						
959400	L7167	White	□ 199.6 x 289.1mm	1	10	10
959401	L7168	White	□ 199.6 x 143.5mm	2	10	20
959402	L7169	White	□ 99.1 x 139mm	4	10	40
959403	L7165	White	□ 99.1 x 67.7mm	8	10	80
959406	L7175	White	□ 105 x 148mm (A6)	1	25	25
<b>*Weatherproof</b>						
959409*	L7070	White Weatherproof	□ 99.1 x 67.7mm	8	10	80

\*Not FSC Certified. Not available with Trueblock® and for Laser printers only.

### Enviro Labels Laser

- Label material 100% environmentally friendly recycled material
- Made with water soluble adhesive
- Customise your labels with our free and easy-to-use template software; Avery Design and Print – available at [averyproducts.com.au/print](http://averyproducts.com.au/print)
- Jam-Free™ reliability for trouble free printing on Laser printers, saving time and minimising wastage
- FSC® certified labels made with paper from well-managed forests









Code	Software Code	Colour	Size	Labels per Sheet	Sheets per Pack	Labels per Pack
959120	L7167EV	White	□ 199.6 x 289.1mm	1	100	100
959121	L7163EV	White	□ 99.1 x 38.1mm	14	100	1400
959122	L7159EV	White	□ 64 x 33.8mm	24	100	2400
959123	L7651EV	White	□ 38.1 x 21.2mm	65	100	6500

### Kraft Brown Labels Laser

- Brown Kraft labels blend onto cardboard and completely block out what is underneath, allowing you to re-use old boxes and parcels
- Customise your labels with our free and easy-to-use template software; Avery Design and Print – available at [averyproducts.com.au/print](http://averyproducts.com.au/print)
- The label paper is made of 100% recycled material, processed chlorine-free and is recyclable
- Ship more efficiently and reduce your impact on the environments



Code	Software Code	Colour	Size	Labels per Sheet	Sheets per Pack	Labels per Pack
959410	L7185	Kraft Brown	■ 105 x 148mm (A6)	1	20	20
959125	L7168	Kraft Brown	■ 199.6 x 143.5mm	2	20	40





*Did you know?*

Creating an element of curiosity is an effective way of attracting potential customers to your item, whether that's to encourage a purchase or open a parcel.

*Did you know?*

Using multiple labels in shipping achieves more of the desired outcomes than just using one. Multiple labels increase brand love by 129% and 116% for parcel content quality.

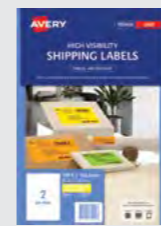

**High Visibility Labels Laser**

- Fluoro coloured labels make your parcels and items highly visible and enable instant recognition
- Jam-Free™ reliability for trouble free printing on Laser printers, saving time and minimising wastage
- Customise your labels with our free and easy-to-use template software; Avery Design and Print – available at [averyproducts.com.au/print](http://averyproducts.com.au/print)
- Ideal for marking documents, and files that need special attention and for labelling products and packaging for selling or shipping
- Available in a wide range of colours and sizes to suit your shipping needs



Code	Software Code	Colour	Size	Labels per Sheet	Sheets per Pack	Labels per Pack
959404	L7168FO	Fluoro Orange	199.6 x 143.5mm	2	10	20
959405	L7168FY	Fluoro Yellow	199.6 x 143.5mm	2	10	20
959408	L7168FG	Fluoro Green	199.6 x 143.5mm	2	10	20
959407	L7175FY	Fluoro Yellow	105 x 148mm ( A6 )	1	20	20
35998	L7167FP	Fluoro Pink	199.6 x 289.1mm	1	25	25
35999	L7167FY	Fluoro Yellow	199.6 x 289.1mm	1	25	25
36100	L7168FY	Fluoro Yellow	199.6 x 143.5mm	2	25	50
36102	L7165FY	Fluoro Yellow	99.1 x 67.7mm	8	25	200
36103	L7165FO	Fluoro Orange	99.1 x 67.7mm	8	25	200
36104	L7165FG	Fluoro Green	99.1 x 67.7mm	8	25	200
35937	<b>BEST SELLER</b> L7163FG	Fluoro Green	99.1 x 38.1mm	14	25	350
35947	L7163FY	Fluoro Yellow	99.1 x 38.1mm	14	25	350
35957	L7163FP	Fluoro Pink	99.1 x 38.1mm	14	25	350
35977	L7163FO	Fluoro Orange	99.1 x 38.1mm	14	25	350
35932	<b>BEST SELLER</b> L7162FG	Fluoro Green	99.1 x 34mm	16	25	400
35942	<b>BEST SELLER</b> L7162FY	Fluoro Yellow	99.1 x 34mm	16	25	400
35952	L7162FP	Fluoro Pink	99.1 x 34mm	16	25	400
35972	L7162FO	Fluoro Orange	99.1 x 34mm	16	25	400

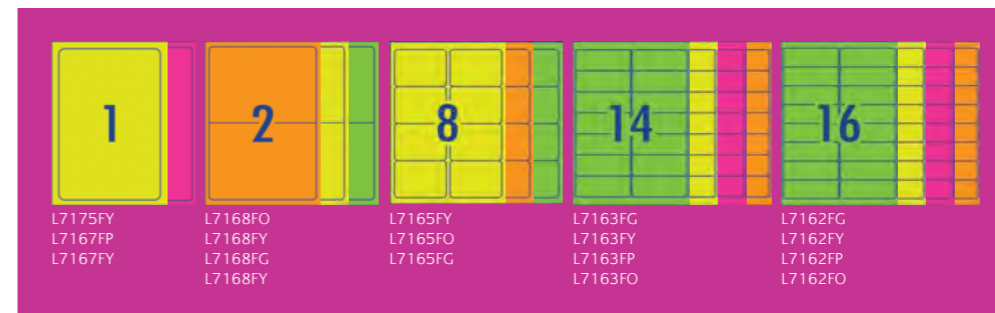



### Crystal Clear Labels Laser

- Clear labels virtually disappear when applied to white and coloured surfaces for a printed on look
- Made from durable material, which is oil, dirt, splash and tear proof
- Customise your labels with our free and easy-to-use template software; Avery Design and Print – available at [averyproducts.com.au/print](http://averyproducts.com.au/print)
- Jam-Free™ reliability for trouble free printing on Laser printers, saving time and minimising wastage
- Ideal for sending elegant parcels, gifts and boxes



Code	Software Code	Colour	Size	Labels per Sheet	Sheets per Pack	Labels per Pack
959065 <b>BEST SELLER</b>	L7567	Crystal Clear	199.6 x 289.1mm	1	25	25
959066	L7566	Crystal Clear	199.6 x 143.5mm	2	25	50
959052	L7565	Crystal Clear	99.1 x 67.7mm	8	25	200
959051 <b>BEST SELLER</b>	L7563	Crystal Clear	99.1 x 38.1mm	14	25	350
959050	L7562	Crystal Clear	99.1 x 34mm	16	25	400
959055	L7560	Crystal Clear	63.5 x 38.1mm	21	25	525
959022 <b>BEST SELLER</b>	L7551	Crystal Clear	38.1 x 21.2mm	65	25	1625



### Frosted Clear Labels Inkjet

- Labels provide a contemporary frosted finish
- Compatible with Inkjet printers and smudge-free™ for a professional finish
- Customise your labels with our free and easy-to-use template software; Avery Design and Print – available at [averyproducts.com.au/print](http://averyproducts.com.au/print)
- Quick Peel™ technology allows for quicker and easier detachment of labels from backing sheet
- Ideal for elegant parcels, boxes and gifts with black or dark surfaces



Code	Software Code	Colour	Size	Labels per Sheet	Sheets per Pack	Labels per Pack
936008*	J8167	Frosted Clear	199.6 x 289.1mm	1	25	25
936002*	J8566	Frosted Clear	199.6 x 143.5mm	2	25	50
936004	J8565	Frosted Clear	99.1 x 67.7mm	8	25	200
936005	J8563	Frosted Clear	99.1 x 38.1mm	14	25	350
936006	J8562	Frosted Clear	99.1 x 34mm	16	25	400
936007	J8560	Frosted Clear	63.5 x 38.1mm	21	25	525
936009	J8551	Frosted Clear	38.1 x 21.2mm	65	25	1625

\*Not available in Quick Peel™ feature

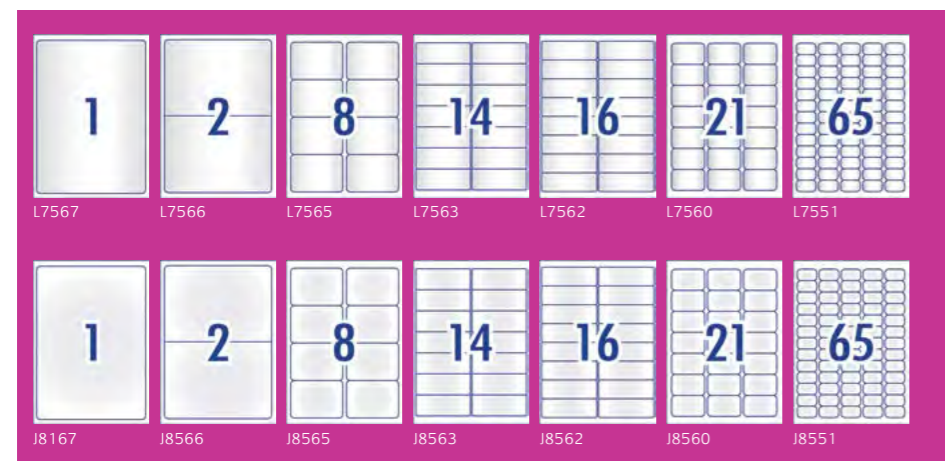

### Filing Labels Laser / Inkjet

- Trueblock® labels feature an opaque silver backing which completely covers up existing labels or existing information on folders
- Labels are compatible with both inkjet and laser printers
- Customise your labels with our free and easy-to-use template software; Avery Design and Print – available at [averyproducts.com.au/print](http://averyproducts.com.au/print)
- Ideal for labelling small folders and files in the home or office
- Available in white, red, blue, green, yellow and assorted



Code	Software Code	Colour	Size	Labels per Sheet	Sheets per Pack	Labels per Pack
<b>Lever Arch Label</b>						
959072 <b>BEST SELLER</b>	L7171B	Blue	200 x 60mm	4	10	40
959073	L7171G	Green	200 x 60mm	4	10	40
959074	L7171R	Red	200 x 60mm	4	10	40
959083	L7171Y	Yellow	200 x 60mm	4	10	40
959035 <b>BEST SELLER</b>	L7171	White	200 x 60mm	4	25	100
959084	L7171	Assorted	200 x 60mm	4	25	100
<b>Spine Label</b>						
959036	L7172	White	100 x 30mm	18	25	450
959058 <b>BEST SELLER</b>	L7170	White	134 x 11mm	24	25	600



### Suspension Tab Filing Card

- Specifically designed to fit suspension file tabs
- File Tabs are compatible with both inkjet and laser printers
- Customise your file tabs with our free and easy-to-use template software; Avery Design and Print – available at [averyproducts.com.au/print](http://averyproducts.com.au/print)
- Micro-perforated to separate easily and cleanly



Code	Software Code	Colour	Size	Labels per Sheet	Sheets per Pack	Labels per Pack
959075	L7409	White	57 x 15mm	51	25	1275

\* Card Only Product



### Reinforcement Ring Labels

- Standard size clear vinyl reinforcement rings
- Permanent adhesive
- Available in easy to dispense units

Code	Colour	Size	Labels per Roll
934242	Clear	13mm diameter	250
934241	Clear	13mm diameter	500





### Matt & Gloss Labels Laser

- Special material provides vivid colour and sharp text for brilliant, high resolution colour images
- Specifically designed for colour laser printers
- Customise your labels with our free and easy-to-use template software; Avery Design and Print – available at [averyproducts.com.au/print](http://averyproducts.com.au/print)
- Available in either matt or glossy materials



Code	Software Code	Colour	Size	Labels per Sheet	Sheets per Pack	Labels per Pack
<b>Matt</b>						
959770	L7167CL	White	199.6 x 289.1mm	1	20	20
959771	L7165CL	White	99.1 x 67.7mm	8	20	160
959772	L7163CL	White	99.1 x 38.1mm	14	20	280
959773	L7162CL	White	99.1 x 34mm	16	20	320
959774	L7160CL	White	63.5 x 38.1mm	21	20	420
959775	L7651CL	White	38.1 x 21.2mm	65	20	1300
<b>Gloss</b>						
959767	L7767	White	199.6 x 289.1mm	1	25	25
959768	L7768	White	199.6 x 143.5mm	2	25	50
959769	L7769	White	99.1 x 139mm	4	25	100
959765	L7765	White	99.1 x 67.7mm	8	25	200

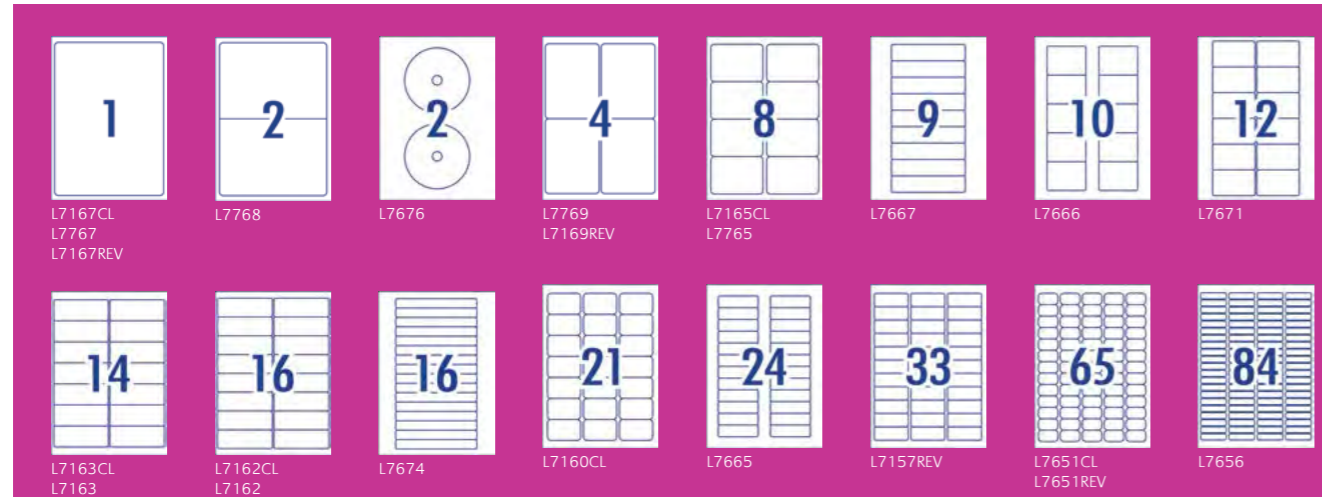

### Removable Multi-Purpose Labels Laser / Inkjet

- Labels adhere securely to any smooth surface and can be easily removed when needed
- Jam-Free™ reliability for trouble free printing on Laser printers, saving time and minimising wastage
- Customise your labels with our free and easy-to-use template software; Avery Design and Print – available at [averyproducts.com.au/print](http://averyproducts.com.au/print)
- Labels peel off easily when required, enabling you to update information easily or use the item again
- Perfect for temporary identification



Code	Software Code	Colour	Size	Labels per Sheet	Sheets per Pack	Labels per Pack
959150	L7167REV	White	199.6 x 289.1mm	1	25	25
959151	L7169REV	White	99.1 x 139mm	4	25	100
959046	L7163	White	99.1 x 38.1mm	14	25	350
959048	L7162	White	99.1 x 34mm	16	25	400
959152	L7157REV	White	64 x 24.3mm	33	25	825
959049	L7651REV	White	38.1 x 21.2mm	65	25	1625
959053	L7656	White	46 x 11.11mm	84	25	2100



### Permanent Multi Purpose Labels Laser / Inkjet

- Permanent adhesive sticks to multiple surfaces like glass, metal, paper and plastic
- Compatible with Laser and Inkjet printers
- Customise your labels with our free and easy-to-use template software; Avery Design and Print – available at [averyproducts.com.au/print](http://averyproducts.com.au/print)
- Ideal for identifying objects around the home or office



Code	Software Code	Colour	Size	Labels per Sheet	Sheets per Pack	Labels per Pack
959034	L7667	White Rectangle	133 x 29.61mm	9	25	225
959033	L7666	White Rectangle	70 x 52mm	10	25	250
959023	L7671	White Rectangle	76.2 x 46.4mm	12	25	300
959024	L7674	White Rectangle	145 x 17mm	16	25	400
959032	L7665	White Rectangle	72 x 21.15mm	24	25	600
959018	L7656	White Rectangle	46 x 11.11mm	84	25	2100



### Permanent CD Labels Laser / Inkjet

- Customisable CD labels for easy identification
- Compatible with Laser and Inkjet printers
- Customise your labels with our free and easy-to-use template software; Avery Design and Print – available at [averyproducts.com.au/print](http://averyproducts.com.au/print)



Code	Software Code	Colour	Size	Labels per Sheet	Sheets per Pack	Labels per Pack
960101	L7676	White CD Labels	117mm diameter	2	25	50



*Did you know?* Consumers are prepared to pay more money for products with labels that convey quality – quality labels, quality design and a message of quality.

### Round White Permanent Labels – Laser

- Suitable for a variety of purposes around the home or office
- Specifically designed for colour laser printers
- Customise your labels with our free and easy-to-use template software; Avery Design and Print – available at [averyproducts.com.au/print](http://averyproducts.com.au/print)
- Jam-Free™ Technology saves time and minimises waste







Code	Software Code	Colour	Size	Labels per Sheet	Sheets per Pack	Labels per Pack
White						
959145	L7630	White Round	□ 63.5mm diameter	12	10	120
959146	L6112	White Round	□ 40mm diameter	24	10	240

### Round & Oval Crystal Clear Permanent Labels – Laser

- Suitable for a variety of purposes around the home or office
- Jam-Free™ reliability for trouble free printing on Laser printers, saving time and minimising wastage
- Customise your labels with our free and easy-to-use template software; Avery Design and Print – available at [averyproducts.com.au/print](http://averyproducts.com.au/print)
- Made from durable material, which is oil, dirt, splash and tear proof
- Ideal for use in your kitchen, garage or home office







Code	Software Code	Colour	Size	Labels per Sheet	Sheets per Pack	Labels per Pack
Crystal Clear						
959165	L6024C	Crystal Clear Oval	□ 63.5 x 42.3mm	18	10	180
959164	 L6112C	Crystal Clear Round	□ 40mm diameter	24	10	240

### Round Frosted Clear Permanent Labels – Inkjet

- Suitable for a variety of purposes around the home or office
- Inkjet labels are Smudge-Free™ for a professional finish
- Customise your labels with our free and easy-to-use template software; Avery Design and Print – available at [averyproducts.com.au/print](http://averyproducts.com.au/print)
- Ideal for dark coloured paper or wedding invitations

Code	Software Code	Colour	Size	Labels per Sheet	Sheets per Pack	Labels per Pack
959166	J6112C	Frosted Clear Round	□ 40mm diameter	24	10	240





### A5 Coloured Labels Laser / Inkjet

- Premium pastel coloured labels are ideal for addressing, identification & organisation
- Compatible with Laser and Inkjet printers
- Customise your labels with our free and easy-to-use template software; Avery Design and Print – available at [averyproducts.com.au/print](http://averyproducts.com.au/print)
- Convenient A5 sheet pack for home use

Code	Software Code	Colour	Size	Labels per Sheet	Sheets per Pack	Labels per Pack
393060*	L7264	Almond Brown	94 x 32mm	8	10	80
393080*	L7264	Copper Brown	94 x 32mm	8	10	80
393090*	L7264	Gun Metal Grey	94 x 32mm	8	10	80
393000	L7264	Lavender Purple	94 x 32mm	8	10	80
393020	L7264	Mint Green	94 x 32mm	8	10	80
393030	L7264	Peachy Pink	94 x 32mm	8	10	80
393050*	L7264	Pistachio Grey	94 x 32mm	8	10	80
393040	L7264	Salmon Pink	94 x 32mm	8	10	80
393010 <b>BEST SELLER</b>	L7264	Sky Blue	94 x 32mm	8	10	80
393070*	L7264	Storm Grey	94 x 32mm	8	10	80
393260*	L7261	Almond Brown	63.5 x 24mm	16	10	160
393280*	L7261	Copper Brown	63.5 x 24mm	16	10	160
393290*	L7261	Gun Metal Grey	63.5 x 24mm	16	10	160
393200 <b>BEST SELLER</b>	L7261	Lavender Purple	63.5 x 24mm	16	10	160
393220	L7261	Mint Green	63.5 x 24mm	16	10	160
393230	L7261	Peachy Pink	63.5 x 24mm	16	10	160
393250*	L7261	Pistachio Grey	63.5 x 24mm	16	10	160
393240	L7261	Salmon Pink	63.5 x 24mm	16	10	160
393210 <b>BEST SELLER</b>	L7261	Sky Blue	63.5 x 24mm	16	10	160
393270*	L7261	Storm Grey	63.5 x 24mm	16	10	160

\* While Stocks Last



### Freezer Safe Days of the Week Dispenser Labels

- Labels are dishwasher, freezer and microwave safe
- Ideal for use on glass or plastic food containers
- Removable adhesive sticks to multiple surfaces and removes cleanly
- Freezer safe
- Temperature -10°C to +60°C



Code	Description	Colour	Size	Labels per Roll
937321	Monday	Blue	24 x 24 mm	100
937322	Tuesday	Yellow	24 x 24 mm	100
937323	Wednesday	Red	24 x 24 mm	100
937324	Thursday	Brown	24 x 24 mm	100
937325	Friday	Green	24 x 24 mm	100
937327	Saturday	Orange	24 x 24 mm	100
937328	Sunday	Black	24 x 24 mm	100

### White Rectangle & Square Labels

- Multi-purpose identification labels
- Labels come in a handy dispenser pack for ease of use
- Great for often repeated tasks when you require easy access to labels
- Removable adhesive



Code	Colour	Size	Labels per Roll
937303	White Rectangular	10 x 16mm	1500
937226	White Rectangular	101 x 24mm	160
937206	White Rectangular	24 x 10mm	1200
937209	White Rectangular	24 x 13mm	900
937305	White Rectangular	24 x 16mm	800
937215	White Rectangular	24 x 19mm	650
937216	White Rectangular	30 x 19mm	550
937219	White Rectangular	32 x 24mm	420
937304	White Rectangular	34 x 10mm	750
937210	White Rectangular	36 x 13mm	700
937217	White Rectangular	36 x 19mm	450
937220	White Rectangular	38 x 24mm	380
937212	White Rectangular	49 x 13mm	550
937221	White Rectangular	49 x 24mm	325
937222	White Rectangular	49 x 35mm	220
937223	White Rectangular	63 x 44mm	150
937218	White Rectangular	64 x 19mm	280
937224	White Rectangular	76 x 27mm	180
937306	White Rectangular	76 x 29mm	180
937225	White Rectangular	89 x 43mm	100
937289	White Square	19 x 19mm	900

### Coloured Circle Labels

- Multi-purpose identification labels
- Labels come in a handy dispenser pack for ease of use
- Great for often repeated tasks when you require easy access to labels
- Removable adhesive
- Available in a wide range of sizes and colours



Code	Colour	Size	Labels per Roll
937235	Red	14mm diameter	1050
937236	Blue	14mm diameter	1050
937237	Brown	14mm diameter	1050
937238	Green	14mm diameter	1050
937239	Yellow	14mm diameter	1050
937240	Orange	14mm diameter	1050
937241	Pink	14mm diameter	1050
937242	Black	14mm diameter	1050
937264	Purple	14mm diameter	1050
937273	Gold	14mm diameter	250
937274	Silver	14mm diameter	500
937275	Light Blue	14mm diameter	500
937294	Fluoro Yellow	14mm diameter	700
937296	Fluoro Green	14mm diameter	700
937298	Fluoro Red	14mm diameter	700
937300	Fluoro Orange	14mm diameter	350
937200	White	14mm diameter	1200
937292	White	18mm diameter	900
937243	Red	24mm diameter	500
937244	Blue	24mm diameter	500
937245	Brown	24mm diameter	500
937246	Green	24mm diameter	500
937247	Yellow	24mm diameter	500
937248	Orange	24mm diameter	500
937249	Pink	24mm diameter	500
937250	Black	24mm diameter	500
937265	Purple	24mm diameter	250
937271	Gold	24mm diameter	250
937272	Silver	24mm diameter	250
937276	Light Blue	24mm diameter	500
937295	Fluoro Yellow	24mm diameter	350
937297	Fluoro Green	24mm diameter	350
937299	Fluoro Red	24mm diameter	350
937301	Fluoro Orange	24mm diameter	350
937202	White	24mm diameter	550
937293	White	32mm diameter	350





### Pre-printed Point of Sale Dispenser Labels

- Bright pre-printed point of sale labels for immediate recognition
- Labels come in a handy dispenser pack for ease of use
- Great for often repeated tasks when you require easy access to labels
- Removable adhesive
- Available in a range of pre-printed messages using fluoro colours



Code	Description	Size	Labels per Roll
937307	Sold printed Red	19 x 64mm	250
937311	Sale	24mm diameter	500
937312	Special	24mm diameter	500
937313	10% Off	24mm diameter	500
937314	20% Off	24mm diameter	500
937315	25% Off	24mm diameter	500
937316	30% Off	24mm diameter	500
937317	50% Off	24mm diameter	500
937255	Sale Price	30 x 24mm	250
937309	Sale Was / Now	44 x 63mm	250
937253	Sold To	64 x 19mm	250
937318	Sale Price	64 x 19mm	250
937319	Clearance	64 x 19mm	250
937320	Reduced	64 x 19mm	250

### Pre-printed Dispenser Labels

- Bright pre-printed labels for immediate recognition
- Labels come in a handy dispenser pack for ease of use
- Great for often repeated tasks when you require easy access to labels
- Removable adhesive
- Available in a range of pre-printed messages using fluoro colours



Code	Description	Size	Labels per Roll
937259	Urgent Action	64 x 19mm	125
937260	Final Notice	64 x 19mm	125
937261	Friendly Reminder	64 x 19mm	125
937262	Any Reason	64 x 19mm	125
937251	Urgent	64 x 19mm	125
937252	Fragile	64 x 19mm	125

### Dot Matrix Labels

- Dot matrix labels in a continuous fanfolds for large mainframe printers or invoice processing

Code	Colour	Size	Across	Labels per Pack
939126	White	152 x 74mm	1 Wide	2000
939120	White	89 x 24mm	1 Wide	2500
939122	White	102 x 36mm	1 Wide	2500
939100	White	89 x 24mm	1 Wide	10000
939109	White	102 x 36mm	1 Wide	10000
939210	White	102 x 36mm	2 Wide	10000



### Roll Address Labels

- Perfect for handwriting or identification purposes
- White, permanent labels
- Labels are on a roll for easy dispensing and frequent use
- Perforated between each label for easy separation



Code	Colour	Size	Labels per Roll
937106	White	89 x 24mm	250
937108	White	102 x 36mm	250
937103	White	63 x 36mm	500
937104	White	70 x 36mm	500
937105	White	78 x 48mm	500
937107	White	89 x 24mm	500
937109	White	102 x 36mm	500
937110	White	125 x 36mm	500
937111	White	102 x 49mm	500
937112	White with Black Border	78 x 48mm	500



### Blister Pack Labels – Coloured Shapes

- Multi-purpose stickers for everyday use
- Suitable for a range of identification projects in the home, school or office
- Permanent adhesive
- Available in resealable handipacks
- Available in a wide range of shapes and colours

Code	Colour	Size	Labels per Roll
932001	White Circle	8mm diameter	624
932291	Assorted Circle (Blue, Green, Yellow, Red)	8mm diameter	416
932002	White Circle	12mm diameter	270
932281	Fluoro Red Circle	12mm diameter	216
932282	Fluoro Green Circle	12mm diameter	216
932294	Assorted Circle (Green, Yellow, Red)	12mm diameter	162
932350	Gold Star	14mm diameter	90
932351	Silver Star	14mm diameter	90
932352	Assorted Small Stars (Green, Silver, Red, Gold, Blue)	14mm diameter	90
932361	Silver Hearts	15mm diameter	70
932362	Gold Hearts	15mm diameter	70
932363	Red Hearts	15mm diameter	70
932292	Assorted Circle (Blue, Green, Yellow, Red)	16mm diameter	120
932289	Fluoro Yellow Circle	18mm diameter	120
932353	Gold Star	21mm diameter	36
932354	Silver Star	21mm diameter	36
932355	Gold Heart	23mm diameter	30
932356	Silver Heart	23mm diameter	30
932357	Red Heart	23mm diameter	30
932445	Number 00-99 White with Black Numbers	11 x 11mm	144
932443	Number 1-500 Black with White Numbers	12 x 12mm	500
932448	Alphabet Gold Lettering A-Z	13 x 13mm	48
932297	Assorted (Blue, Green, Yellow, Red)	18 x 12mm	144
932073	Australian Flag	36 x 19mm	20

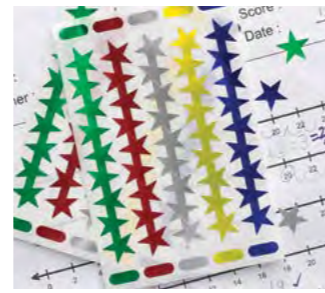

### Blister Pack Labels – Rectangle

- Multi-purpose stickers for everyday use
- Suitable for a range of identification projects in the home, school or office
- Permanent adhesive
- Available in resealable handipacks

Code	Colour	Size	Labels per Packet
932015	White	12 x 18mm	216
932018	White	14 x 38mm	105
932022	White	18 x 38mm	72
932024	White	24 x 38mm	63
932026	White	25 x 50mm	42
932016	White	30 x 12mm	132
932063	White	39 x 50mm	28
932009	White	50 x 6mm	140
932023	White	62 x 19mm	35
932384	White	75 x 34mm	18
932029	White	76 x 19mm	30
932033	White	76 x 34mm	21
932036	White	80 x 54mm	14
932041	White	116 x 78mm	7
932384	White with Blue Border	75 x 34mm	18



### Unistat Labels Laser / Inkjet / Copier

- Compatible with Inkjet Printers
- Ideal for addressing and other applications
- Suited to medium speed, black and white photocopiers and laser printers



Code	Software Code	Colour	Size	Labels per Sheet	Sheets per Pack	Labels per Pack
38939	38939	White	297 x 210mm	1	100	100
38940	38940	White Back Slit	297 x 210mm	1	100	100
38938	38938	White	148 x 210mm	2	100	200
38930	38930	White	105 x 148mm	4	100	400
38934	38934	White	105 x 74mm	8	100	800
38947	38947	White	68 x 70mm	12	100	1200
38937	38937	White	98 x 38mm	14	100	1400
38942	38942	White	99 x 34mm	16	100	1600
38932	38932	White	105 x 37mm	16	100	1600
38936	38936	White	98 x 25.4mm	20	100	2000
38941	38941	White	63.5 x 38mm	21	100	2100
38933	38933	White	70 x 36mm	24	100	2400
38935	38935	White	64 x 25.4mm	30	100	3000
38931	38931	White	70 x 25mm	33	100	3300
38948	38948	White	51 x 15mm	45	100	4500
38965	38965	White	38.1 x 21.2mm	65	100	6500

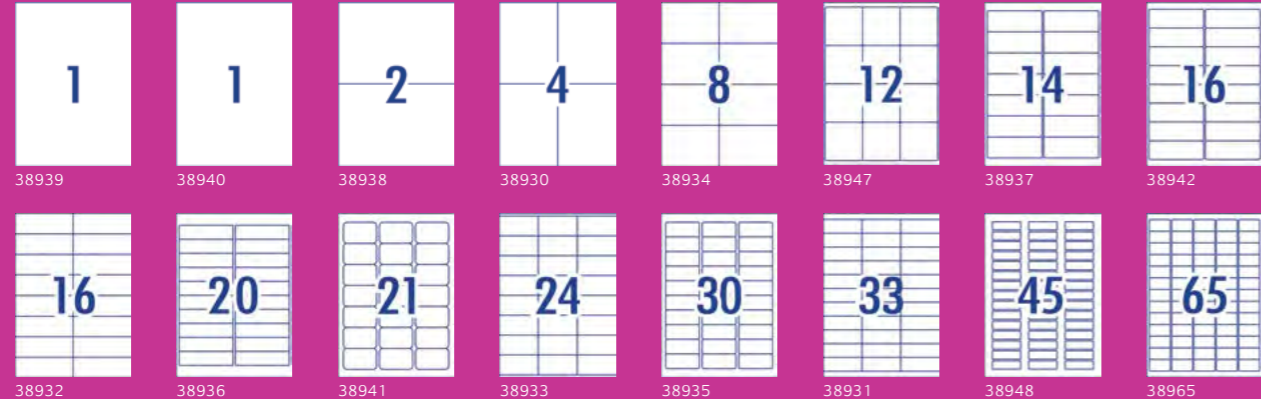

### TRIM Filing Laser / Inkjet Labels

- Specially designed to use with TRIM software
- 3 sizes available



Code	Colour	Size	Labels per Sheet	Sheets per Packet
38944	White	50.8 x 187mm	4	100
38945	White	50.8 x 210mm	5	100
38946	White	45.5 x 139.7mm	6	100



### Avery General Use Labels Laser / Inkjet / Copier

- Ideal for mailing lists, account reminders and other frequent use applications
- Suited to medium speed, black and white laser printers and photocopiers
- FSC® certified labels made with paper from well-managed forests
- Jam-Free™ Technology saves time and minimises waste



Code	Software Code	Colour	Size	Labels per Sheet	Sheets per Pack	Labels per Pack
938203	L7167GU	White	199.6 x 289.1mm	1	100	100
938206	L7169GU	White	99.1 x 139mm	4	100	400
938207	L7165GU	White	99.1 x 67.7mm	8	100	800
938208	L7164GU	White	63.5 x 72mm	12	100	1200
938209	L7163GU	White	99.1 x 38.1mm	14	100	1400
938202	L7162GU	White	99.1 x 34mm	16	100	1600
938210	L7161GU	White	63.5 x 46.6mm	18	100	1800
938201	L7159GU	White	64 x 33.8mm	24	100	2400
938211	L7158GU	White	64 x 26.7mm	30	100	3000
938200	L7157GU	White	64 x 24.3mm	33	100	3300
938212	L7156GU	White	58 x 17.8mm	45	100	4500

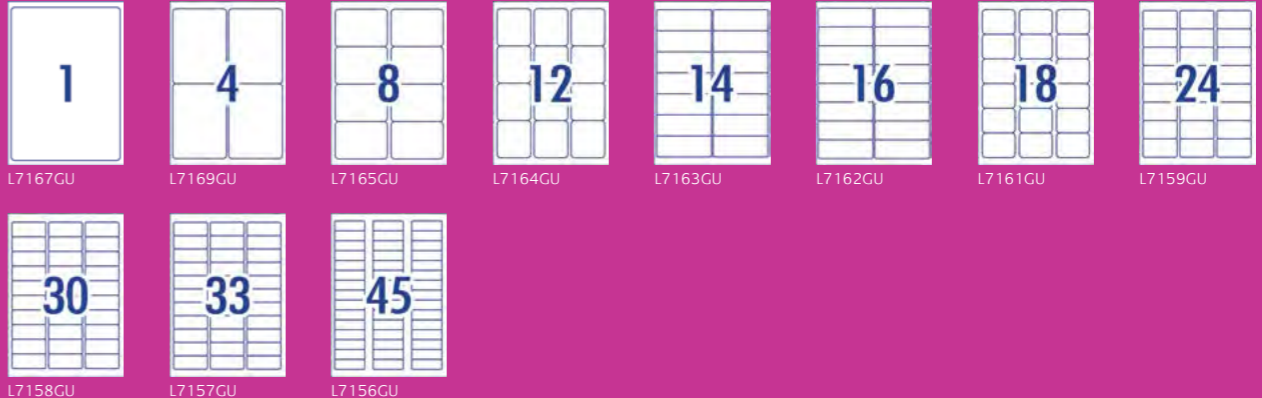



# Conference & Events

Avery has an extensive range of innovative, printable solutions, purpose-designed to help streamline your event organisation.

Using our FREE pre-designed templates at Avery Design & Print you can carry your identity across all collateral from personalised name badge labels, delegate cards, and invitations to make your next event a running success.



**- Best Seller -**  
**Avery Print & Divide Name Badge Labels**  
 As easy as print, divide & go

**Fabric Print & Divide Name Badge Labels Laser**

- Ideal for branding your events, networking functions and conferences
- Made from flexible fabric material with removable adhesive that can be used on most textiles and removed without leaving residue
- Customise your name badges with our free and easy-to-use template software; Avery Design and Print – available at [averyproducts.com.au/print](http://averyproducts.com.au/print)
- Print & Divide feature allows you to tear off, sort and distribute your badges easily

FREE TEMPLATES  
 Avery Design & Print  
 MADE IN AUSTRALIA

Code	Software Code	Colour	Size	Labels per Sheet	Sheets per Pack	Labels per Pack
980040	L7427	White	88 x 52mm	10	15	150

**Fabric Name Badge Labels Laser**

- Ideal for seminars, meetings, trade fairs, conferences and training sessions
- Fabric material is made from flexible acetate silk and can be used on most textiles and removed without leaving residue
- Customise your name badges with our free and easy-to-use template software; Avery Design and Print – available at [averyproducts.com.au/print](http://averyproducts.com.au/print)
- Guaranteed Jam Free printing on laser printers

FREE TEMPLATES  
 Avery Design & Print  
 MADE IN AUSTRALIA

Code	Software Code	Colour	Size	Labels per Sheet	Sheets per Pack	Labels per Pack
959171	L7418	White	86.5 x 55.5mm	8	15	120
959170	L4784	White	63.5 x 29.6mm	27	15	405

**Card Name Badge Kit Laser / Inkjet**

- Refill contains 25 sheets each with 8 perforated name badges
- Kit contains 20 clip style badge holders, 3 sheets of laser card each with 8 perforated badges
- Customise your name badges with our free and easy-to-use template software; Avery Design and Print – available at [averyproducts.com.au/print](http://averyproducts.com.au/print)
- Combine with Avery Postcards and Delegate Cards for a co-ordinated, professional solution

FREE TEMPLATES  
 Avery Design & Print  
 MADE IN AUSTRALIA

Code	Software Code	Colour	Size	Labels per Sheet	Sheets per Pack	Labels per Pack
947002	L7418K	White	86.5 x 55.5mm	8	25	200



*Did you know?*

You can use your contact list to create Name Badge Labels quickly and easily without needing to download software. Simply visit [averyproducts.com.au/print](http://averyproducts.com.au/print) or [avery.co.nz/print](http://avery.co.nz/print)

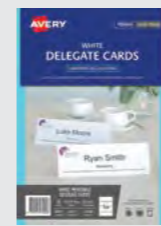

### Card Products Laser / Inkjet – Delegate Cards

- Quick and easy solution for professional communication and presentation
- Cards are instantly available, saving you time
- Customise your cards with our free and easy-to-use template software; Avery Design and Print – available at [averyproducts.com.au/print](http://averyproducts.com.au/print)
- Combine with Avery Business Cards and Postcards for a co-ordinated, professional solutions



Code	Software Code	Colour	Size	Labels per Sheet	Sheets per Pack	Cards per Pack
947000	L7423	White	210 x 74.25mm	2	25	50

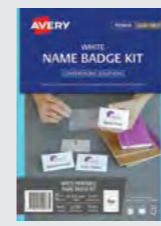

### Card Name Badges Refill Laser / Inkjet

- Refill contains 25 sheets each with 8 perforated name badges
- Kit contains 20 clip style badge holders, 3 sheets of laser card each with 8 perforated badges
- Customise your name badges with our free and easy-to-use template software; Avery Design and Print – available at [averyproducts.com.au/print](http://averyproducts.com.au/print)
- Combine with Avery Postcards and Delegate Cards for a co-ordinated, professional solution



Code	Software Code	Colour	Size	Labels per Sheet	Sheets per Pack	Labels per Pack
959077	L7418K	White	86.5 x 55.5mm	8	20	160



### Card Products Laser / Inkjet – DL Cards

- Quick and easy solution for professional communication and presentation
- Cards are instantly available, saving you time
- Customise your cards with our free and easy-to-use template software; Avery Design and Print – available at [averyproducts.com.au/print](http://averyproducts.com.au/print)
- Combine with Avery Business Cards and Postcards for a co-ordinated, professional solutions



Code	Software Code	Colour	Size	Labels per Sheet	Sheets per Pack	Cards per Pack
980039	C32074	White	210 x 99mm	3	10	30



### Card Products Laser / Inkjet – Multi-Purpose Cards

- Quick and easy solution for professional communication and presentation
- Cards are instantly available, saving you time
- Customise your cards with our free and easy-to-use template software; Avery Design and Print – available at [averyproducts.com.au/print](http://averyproducts.com.au/print)
- Combine with Avery Business Cards and Delegate Cards for a co-ordinated, professional solution



Code	Software Code	Colour	Size	Labels per Sheet	Sheets per Pack	Cards per Pack
947004	L7421	White – 150gsm	139.37 x 97.29mm	4	10	40
980038	C32074	White – 260gsm	85 x 54mm	8	10	80



### 'Hello I'm' Roll Labels

- Bright pre-printed labels for immediate recognition
- Labels come in a handy roll dispenser pack for ease of use
- Great for often repeated tasks when you require easy access to labels
- Removable adhesive



Code	Colour	Size	Labels per Sheet	Sheets per Pack
937263	White printed blue	58 x 43mm	100	20

Page 37



L7418 L7418K L7484 L7427 L7418K

Page 39



L7423 L7418K C32074 L7421 C32074

Page 40

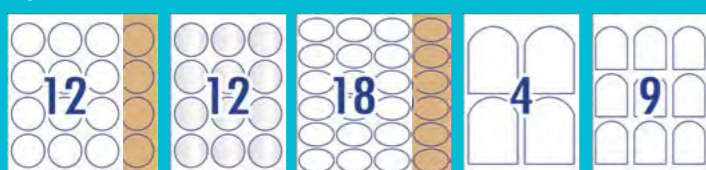

L7100 L7092 L7093 L7138 L7139 L7141 L7140

Page 41



L7137 L7094 L7095 L7142



### Round Labels Laser / Inkjet

- Ideal for branding your events and conferences
- Customise your labels with our free and easy-to-use template software; Avery Design and Print – available at [averyproducts.com.au/print](http://averyproducts.com.au/print)
- Permanent adhesive works on glass, plastic, paper and more

Code	Software Code	Colour	Size	Cards per Sheet	Sheets per Pack	Labels per Pack
980028	L7100	White Gloss	60mm Diameter	12	10	120
980029	L7092	Kraft Brown	60mm Diameter	12	15	180



### Round Labels Laser / Inkjet

- Ideal for branding your events and conferences
- Print-to-the-edge feature allows a full colour background for a professional finish
- Customise your labels with our free and easy-to-use template software; Avery Design and Print – available at [averyproducts.com.au/print](http://averyproducts.com.au/print)
- Permanent adhesive works on glass, plastic, paper and more

Code	Software Code	Colour	Size	Cards per Sheet	Sheets per Pack	Labels per Pack
980030	L7093	Crystal Clear 100% Transparency	60mm Diameter	12	10	120



### Oval Labels Laser / Inkjet

- Ideal for branding your events and conferences
- Customise your labels with our free and easy-to-use template software; Avery Design and Print – available at [averyproducts.com.au/print](http://averyproducts.com.au/print)
- Perfect for use on glass, polished surfaces, as well as on plastics and metal

Code	Software Code	Colour	Size	Cards per Sheet	Sheets per Pack	Labels per Pack
980034	L7138	White Gloss	63.5 x 45.3mm	18	10	180
980035	L7139	Kraft Brown	63.5 x 45.3mm	18	15	270



### Textured Arch Labels Laser / Inkjet

- Ideal for branding your events and conferences Print-to-the-edge feature allows a full colour background for a professional finish
- Customise your labels with our free and easy-to-use template software; Avery Design and Print – available at [averyproducts.com.au/print](http://averyproducts.com.au/print)
- Perfect for liquid containers, as printed colours stay smudge free when wet

Code	Software Code	Colour	Size	Cards per Sheet	Sheets per Pack	Labels per Pack
980037	L7141	White Textured	89 x 120.7mm	4	10	40
980036	L7140	White Textured	57.2 x 77mm	9	15	90



### Rectangle Labels Laser / Inkjet

- Ideal for branding your events and conferences Print-to-the-edge feature allows a full colour background for a professional finish
- Customise your labels with our free and easy-to-use template software; Avery Design and Print – available at [averyproducts.com.au/print](http://averyproducts.com.au/print)
- Permanent adhesive works on glass, plastic, paper and more

Code	Software Code	Colour	Size	Cards per Sheet	Sheets per Pack	Labels per Pack
980033	L7137	Crystal Clear 100% Transparency	96 x 50.8mm	10	10	100



### Square Labels Laser / Inkjet

- Available in both White Gloss and Crystal Clear to give your brand a premium look
- Print-to-the-edge feature allows a full colour background for a professional finish
- Customise your labels with our free and easy-to-use template software; Avery Design and Print – available at [averyproducts.com.au/print](http://averyproducts.com.au/print)
- Permanent adhesive works on glass, plastic, paper and more

Code	Software Code	Colour	Size	Cards per Sheet	Sheets per Pack	Labels per Pack
980031	L7094	White Gloss	45 x 45mm	20	10	200
980032	L7095	*Crystal Clear 100% Transparency	45 x 45mm	20	10	200



### Printable Bag Toppers Laser / Inkjet

- Ideal for branding your events and conferences Bag toppers are made from heavyweight label material and bags are made from polypropylene
- Customise your bag-topppers with our free and easy-to-use template software; Avery Design and Print – available at [averyproducts.com.au/print](http://averyproducts.com.au/print)
- Holds products up to a maximum of 200g

Code	Software Code	Description	Size	Labels per Sheet	Sheets per pack	Bag Toppers per Pack	Bag Toppers per Pack
980042	L7142	Clear Bags	135 x 165mm			40 Bags	
		White Topper	48 x 137mm		4	10	40



### Cling Sheet

- Reusable with whiteboard markers
- Won't damage walls
- Reposition again and again
- Portable: roll it and go

Code	Colour	Description	Size
930101	White	Write On Cling Sheet Removable	667 x 864mm



# Industrial Grade Solutions

Avery Industrial Grade Labels are engineered to withstand harsh environments.

Creating your own safety, asset management, pallet storage and chemical labels has never been easier with our Industrial Grade Labels. Engineered to withstand harsh environments to take on tough applications.

Material Specifications		Resistant to:										
Product	Material Type	Saltwater	Chemicals	Water	UV	Oil	Dirt	Tear-Proof	Permanent Adhesion	Triple Strength Adhesion	Tamper Evident	Temp Variations
Heavy Duty Laser / Inkjet	Polyester			✓	✓	✓	✓	✓	✓			-20°C to +80°C
Heavy Duty Silver	Polyester			✓	✓	✓	✓	✓	✓			-40°C to +150°C
Ultra-Resistant	Polyethylene Film	✓	✓	✓	✓	✓	✓		✓			-40°C to +150°C
Removable	Polyester			✓	✓	✓	✓	✓				-20°C to +80°C
TripleBond™	Polyester			✓		✓	✓	✓		✓		-40°C to +100°C
NoPeel™	Acrylic			✓	✓	✓	✓				✓	-40°C to +100°C
Cable Markers	Polyester						✓	✓	✓			-30°C to +105°C



### Heavy Duty Identification Laser Labels

- Engineered to take on tough applications where a standard label is not fit for purpose
- Durable labels are tear proof, water, dirt, oil and UV resistant with permanent adhesive
- Customise your Heavy Duty labels with our free and easy-to-use template software; Avery Design & Print – available at [averyproducts.com.au/print](http://averyproducts.com.au/print)
- Ideal for asset identification on machinery, equipment, organisation for storage and safety signs
- Unaffected by temperature variations -20°C to +80°C



Code	Software Code	Colour	Size	Labels per Sheet	Sheets per Pack	Labels per Pack
<b>Small Packs</b>						
959096	L7067	White	199.6 x 289.1mm	1	10	10
959162	L6112HD	White Round	40mm Diameter	24	10	240
<b>Large Packs</b>						
959067	L7067	White	199.6 x 289.1mm	1	25	25
959068	L7068	White	199.6 x 143.5mm	2	25	50
959069	L7069	White	99.1 x 139mm	4	25	100
959063	L7063	White	99.1 x 38.1mm	14	25	350
959064	L7060	White	63.5 x 38.1mm	21	25	525
959070	L4778	White	45.7 x 21.2mm	48	25	1200

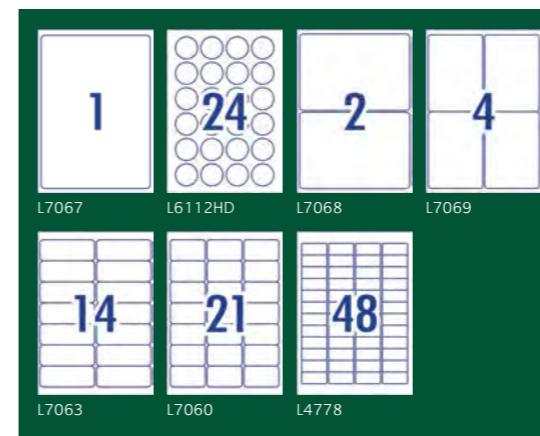

*Did you know?*

Safety First – Make staff and visitors aware of any dangers or hazards in the workplace and create Safety Signs compliant to the standard AS 1319 using Avery Design & Print Online software and templates.

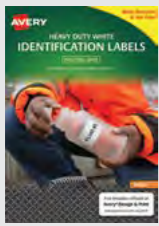

### Heavy Duty Identification Inkjet Labels

- Engineered to take on tough applications where a standard label is not fit for purpose
- Durable labels are tear proof, water, dirt, oil and UV resistant with permanent adhesive
- Customise your Heavy Duty labels with our free and easy-to-use template software; Avery Design & Print – available at [averyproducts.com.au/print](http://averyproducts.com.au/print)
- Ideal for asset identification on machinery, equipment, organisation for storage and safety signs
- Unaffected by temperature variations -20°C to +80°C



Code	Software Code	Colour	Size	Labels per Sheet	Sheets per Pack	Labels per Pack
936067	J4776	White	199.6 x 289.1mm	1	10	10
936068	J4774	White	99.1 x 139mm	4	10	40
936069	J4773	White	64 x 33.8mm	24	10	240



### Silver Heavy Duty Identification Laser Labels

- Engineered to take on tough applications where a standard label is not fit for purpose
- Durable labels are tear proof, water, dirt, oil and UV resistant with permanent adhesive
- Customise your Heavy Duty labels with our free and easy-to-use template software; Avery Design & Print – available at [averyproducts.com.au/print](http://averyproducts.com.au/print)
- Ideal for asset identification on computers, laptops, tablets, tools, labelling medications, samples and containers for use in refrigerators
- Unaffected by temperature variations -40°C to +150°C



Code	Software Code	Colour	Size	Labels per Sheet	Sheets per Pack	Labels per Pack
959204	L6013	Silver	199.6 x 289.1mm	1	20	20
959203	L6012	Silver	96 x 50.8mm	10	20	200
959202	L6011	Silver	63.5 x 29.6mm	27	20	540
959201	L6009	Silver	45.7 x 21.2mm	48	20	960
959200	L6008	Silver	25.4 x 10mm	189	20	3780



### Ultra-Resistant Chemical Grade Identification Laser Labels

- Ultra-Resistant labels are Saltwater Resistant and \*certified for GHS Chemical Labelling Permanent adhesive and engineered to take on harsh environments
- Customise your Ultra-Resistant labels with our free and easy-to-use template software; Avery Design & Print – available at [averyproducts.com.au/print](http://averyproducts.com.au/print)
- Ideal for chemical labelling, chemical decanting on-site, safety signs, arc flash, tanks, marine and outdoor applications
- Unaffected by temperature variations -40°C to +150°C



Code	Software Code	Colour	Size	Labels per Sheet	Sheets per Pack	Labels per Pack
959246	L7917	White	208 x 295mm	1	10	10
959245	L7916	White	210 x 148 mm	2	10	20
959244	L7915	White	99.1 x 139mm	4	10	40
959243	L7914	White	99.1 x 67.7 mm	8	10	80
959242	L7913	White	99.1 x 42.3 mm	12	10	120
959241	L7912	White	63.5 x 33.9 mm	24	10	240
959240	L7911	White	45.7 x 21.2mm	48	10	480

\*Ultra-Resistant material is BS5609 Part 2 certified (label and adhesive durability for at least 90 days in seawater) and is approved for Chemical Hazard Labelling

*Did you know?*

A labels is required for any substance, mixture or article classified as a hazardous chemical under the WHS Regulations. Avery labels help businesses comply with the code of practice.

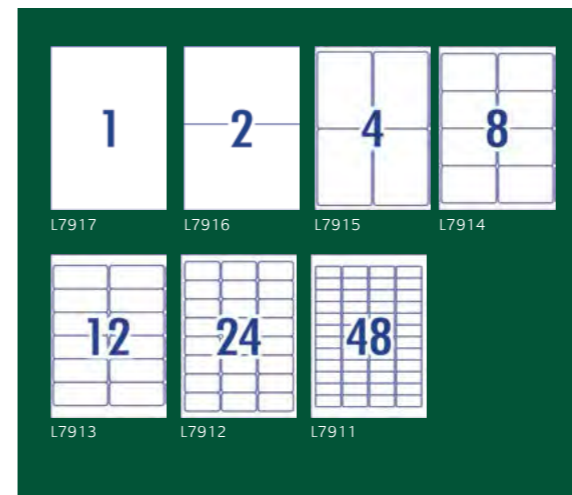
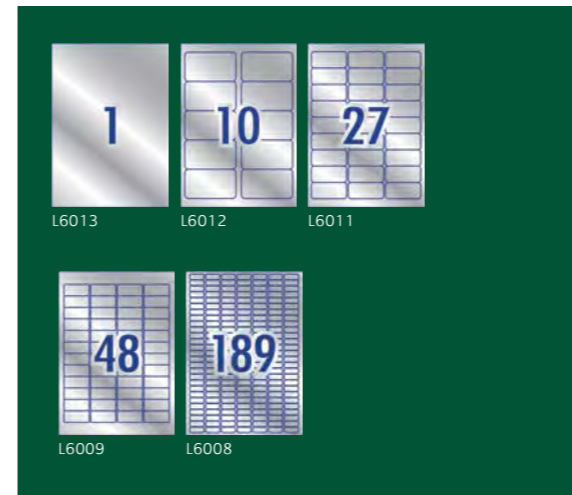
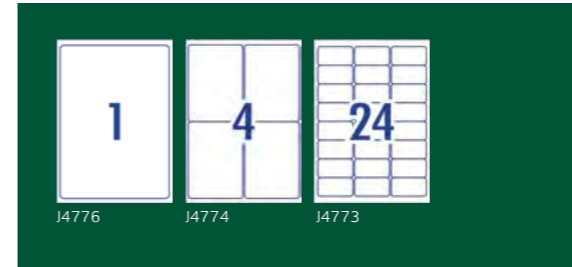



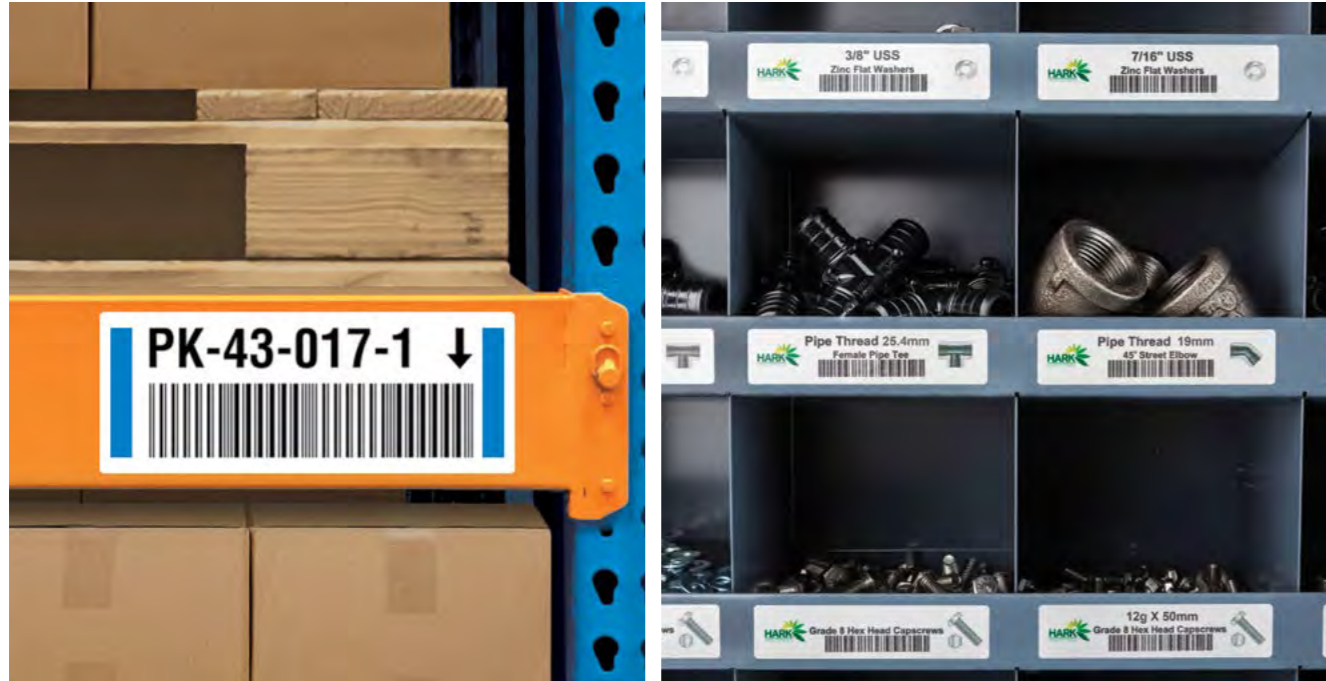

### Removable Identification Laser Labels

- Removable labels without leaving residue on substrate
- Tear proof, weather, UV, oil and dirt resistant
- Customise your Removable labels with our free and easy-to-use template software; Avery Design & Print – available at [averyproducts.com.au/print](http://averyproducts.com.au/print)
- Ideal for creating temporary labelling of equipment, facilities and storage supplies, stock take and organising workshops
- Unaffected by temperature variations -20°C to +80°C



Code	Software Code	Colour	Size	Labels per Sheet	Sheets per Pack	Labels per Pack
959211	L4775REV	White	208 x 295mm	1	20	20
959210	L4774REV	White	99.1 x 139mm	4	20	80
959209	L4715REV	White	99.1 x 67.7mm	8	20	160
959208	L4776REV	White	99.1 x 42.3mm	12	20	240
959207	L4773REV	White	63.5 x 33.9mm	24	20	480
959205	L4778REV	White	45.7 x 21.2mm	48	20	960
959206	L4716REV	White Round	30mm Diameter	48	20	960

### Triple-Bond Identification Laser Labels

- TripleBond™ provides three times stronger adhesion than conventional paper labels
- Tough labels which are tear proof, water, dirt and oil resistant
- Customise your TripleBond™ labels with our free and easy-to-use template software; Avery Design & Print – available at [averyproducts.com.au/print](http://averyproducts.com.au/print)
- Ideal for outdoor applications; identifying scaffolding, drums, containers and use in nurseries
- Unaffected by temperature variations -40°C to +100°C



Code	Software Code	Colour	Size	Labels per Sheet	Sheets per Pack	Labels per Pack
959221	L6141	White	63.5 x 33.9mm	24	10	240
959220	L6140	White	45.7 x 25.4mm	40	10	400

### NoPeel™ Tamper Evident Security Laser Labels

- NoPeel™ tamper-evident labels provides visual evidence if removal has been attempted
- Durable labels are water, dirt, oil and UV resistant with permanent adhesive
- Customise your NoPeel™ labels with our free and easy-to-use template software; Avery Design & Print – available at [averyproducts.com.au/print](http://averyproducts.com.au/print)
- Ideal for labelling laptops, tablets, mobiles, computers, computer screens and office equipment
- Unaffected by temperature variations -40°C to +100°C



Code	Software Code	Colour	Size	Labels per Sheet	Sheets per Pack	Labels per Pack
959231	L6146	White	63.5 x 33.9mm	24	10	240
959230	L6145	White	45.7 x 25.4mm	40	10	400

### Cable Markers Laser

- Printable cable markers provide an easy solution for cable identification
- Fully customisable and heat-resistant makes these markers ideal for organising electronic cables and cords
- Customise your Cable Markers with our free and easy-to-use template software; Avery Design & Print – available at [averyproducts.com.au/print](http://averyproducts.com.au/print)
- Unaffected by temperature variations -30°C to +105°C



Code	Software Code	Colour	Size	Labels per Sheet	Sheets per Pack	Labels per Pack
910006	L7136LT	White	57.2 x 25.4mm	10	5	50

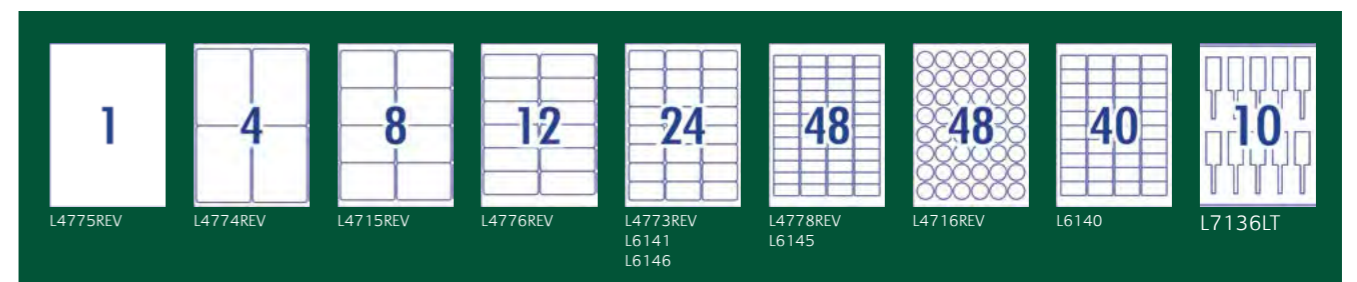

### Thermal Roll Labels

- Direct thermal labels
- Suits a wide range of machinery, including Zebra, Meto, Intermec, Datamax and TEC
- Ideal for creating product and inventory labels for quick and easy identification



Code	Colour	Size	Labels per Roll
937113	White	102 x 36mm	500
937500	White	100 x 48mm	3000
937501	White	100 x 73mm	2000
937503	White	100 x 100mm	1500
937504	White	105 x 150mm	1000
937601	White	101 x 150mm	500
937602	White	101 x 150mm	1000

### Warehouse Labels

- Permanent adhesive ensures labels adhere to boxes and parcels
- The labels help to reduce the risk of damaged goods by providing a clear visual marking which packages need to be handled with care
- Dispenser box which easily dispenses labels



Code	Description	Colour	Size	Labels per Roll
932620	Accepted	Fluoro Green	75 x 48.8mm	1000*
937900*	Fragile	Fluoro Orange	75 x 130mm	1000
932621	Quarantine	Fluoro Orange	75 x 74.2mm	1000
932623	Rejected	Fluoro Red	75 x 74.2mm	1000
932622	Hold	Fluoro Yellow	75 x 36.1mm	750
932614	Mixed Goods	Fluoro Yellow	125 x 75mm	750
932602 <b>BEST SELLER</b>	Fragile	Fluoro Yellow	75 x 99.6mm	750
932618	Glass with Care	Fluoro Yellow	75 x 99.6mm	750
932615	Handle with Care	Fluoro Yellow	75 x 99.6mm	750
932604 <b>BEST SELLER</b>	Heavy	Fluoro Yellow	75 x 99.6mm	750
932619	Invoice Enclosed	Fluoro Yellow	75 x 99.6mm	750
932605 <b>BEST SELLER</b>	This Way Up	Fluoro Yellow	75 x 99.6mm	750
932617	Top Load Only	Fluoro Yellow	75 x 99.6mm	750
932616	Urgent	Fluoro Yellow	75 x 99.6mm	750
932603	Fragile	Fluoro Red	75 x 99.6mm	750

\*Not packaged in dispenser



937900 – Fragile Fluoro Orange



### Warehouse State Labels

- These pre-printed State labels provide a clear visual ideal for identification on cartons and pallets
- Permanent adhesive ensures labels adhere to boxes and parcels
- Dispenser box which easily dispenses labels



Code	Software Code	Colour	Size	Labels per Roll
932608	ACT	Printed Red	100 x 150.4mm	550
932610	NSW	Printed Blue	100 x 150.4mm	550
932612	NT	Printed Black	100 x 150.4mm	550
932613	QLD	Fluoro Red	100 x 150.4mm	500
932611	SA	Fluoro Orange	100 x 150.4mm	500
932606	Tasmania	Fluoro Yellow	100 x 150.4mm	500
932607	Victoria	Fluoro Green	100 x 150.4mm	500
932609	WA	Fluoro Pink	100 x 150.4mm	500



# Food Rotation Labels



Food rotation labels are an essential part of any busy kitchen.

Organise and identify food according to best practice stock rotation methods with Avery's pre-printed and colour-coded fridge and freezer safe labels.



### Day Labels Round Removable

- Write the date on the white section of the label
- Visually identifies discard date of prepared food
- Ideal for refrigeration and freezer food storage applications
- Temperature -5°C to +60°C

Code	Description	Colour	Size	Labels per Roll
937329	Monday	White printed Blue	24mm Diameter	1000
937330	Tuesday	White printed Yellow	24mm Diameter	1000
937331	Wednesday	White printed Red	24mm Diameter	1000
937332	Thursday	White printed Brown	24mm Diameter	1000
937333	Friday	White printed Green	24mm Diameter	1000
937334	Saturday	White printed Orange	24mm Diameter	1000
937335	Sunday	White printed Black	24mm Diameter	1000



### Day Labels Square Removable

- Write the date on the white section of the label
- Visually identifies discard date of prepared food
- Ideal for refrigeration and freezer food storage applications
- Temperature -5°C to +60°C

Code	Description	Colour	Size	Labels per Roll
937336	Monday	White printed Blue	40 x 40mm	500
937337	Tuesday	White printed Yellow	40 x 40mm	500
937338	Wednesday	White printed Red	40 x 40mm	500
937339	Thursday	White printed Brown	40 x 40mm	500
937340	Friday	White printed Green	40 x 40mm	500
937341	Saturday	White printed Orange	40 x 40mm	500
937342	Sunday	White printed Black	40 x 40mm	500



### Preparation Label Removable

- Write the date on the white section of the label
- Visually identifies discard date of prepared food
- Ideal for refrigeration and freezer food storage applications
- Temperature -5°C to +60°C

Code	Description	Colour	Size	Labels per Roll
937343	Use First Label	Yellow printed Black	40mm	500
937344	Use By Label	Printed Red	40mm	500



### Shelf Life Labels Removable

- Write the date on the white section of the label
- Visually identifies discard date of prepared food
- Ideal for refrigeration and freezer food storage applications
- Temperature -5°C to +60°C

Code	Description	Colour	Size	Labels per Roll
937345	Shelf Life Label	White Printed Black	102 x 47mm	500



## Day Labels Dispenser Kit

- This kit provides a complete solution for your Day Label requirements
- Contains a plastic dispenser and one of each Day Labels 24mm Round Monday to Sunday
- Each Day Label roll is on a core and easily feeds through the dispenser
- Convenient and perfectly organised for a productive kitchen environment

Code	Description	Colour	Size	Labels per Roll
937348	Kit includes 1 x roll of each day plus dispenser	Various	24mm	500



## Day Labels Dispenser

- Provides an ideal solution to store your Day Labels 24mm Round
- Labels are readily accessible for use when required
- Keeps everything at hand and organised in a productive kitchen
- 24mm Round Day Labels not included

Code	Description	Colour	Size
937347	Day Labels Dispenser	White <input type="checkbox"/>	W273mm x D159mm x H70mm



## Freezer Safe Days of the Week Labels Removable

- Labels are dishwasher, freezer and microwave safe
- Ideal for use on glass or plastic food containers
- Removable adhesive sticks to multiple surfaces and removes cleanly
- Freezer safe
- Temperature -10°C to +60°C

Code	Description	Colour	Size	Labels per Roll
937321	Monday	White printed Blue	24 x 24mm	100
937322	Tuesday	White printed Yellow	24 x 24mm	100
937323	Wednesday	White printed Red	24 x 24mm	100
937324	Thursday	White Printed Brown	24 x 24mm	100
937325	Friday	White printed Green	24 x 24mm	100
937327	Saturday	White printed Orange	24 x 24mm	100
937328	Sunday	White printed Black	24 x 24mm	100



## Removable Coloured Circle Dispenser Labels – 14mm Diameter

- Multi-purpose identification labels
- Labels come in a handy dispenser pack for ease of use
- Great for often repeated tasks when you require easy access to labels
- Removable adhesive
- Available in a wide range of shapes and colours

Code	Colour	Size	Labels per Roll
937235	Red	14mm diameter	1050
937236	Blue	14mm diameter	1050
937237	Brown	14mm diameter	1050
937238	Green	14mm diameter	1050
937239	Yellow	14mm diameter	1050
937240	Orange	14mm diameter	1050
937242	Black	14mm diameter	1050



## Removable Coloured Circle Dispenser Labels – 24mm Diameter

- Multi-purpose identification labels
- Labels come in a handy dispenser pack for ease of use
- Great for often repeated tasks when you require easy access to labels
- Removable adhesive
- Available in a wide range of shapes and colours

Code	Colour	Size	Labels per Roll
937243	Red	24mm diameter	500
937244	Blue	24mm diameter	500
937245	Brown	24mm diameter	500
937246	Green	24mm diameter	500
937247	Yellow	24mm diameter	500
937248	Orange	24mm diameter	500
937250	Black	24mm diameter	500

See Page 29 for our full coloured circle dispenser label product range.

# Small Business Branding Solutions



Have you started your own small business?  
Are you needing labels to finish off your products or business cards to get your name out there?

Create a cohesive look for your jars, bottles or candles simply with our wide variety of templates on Avery Design & Print. Whether you sell candles or handles, coffee or toffee, lotions or potions, there's a label solution for you.



### Glossy Rectangle Laser / Inkjet Labels

- The glossy finish gives products, packaging and your brand a premium look and feel
- Add bold colours and sharp text onto your label to show off your brand
- Customise your labels with our free and easy-to-use template software; Avery Design and Print – available at [averyproducts.com.au/print](http://averyproducts.com.au/print)
- Permanent adhesive is perfect for glass, plastic, paper and more



Code	Software Code	Description	Colour	Size	Labels per Sheet	Sheets per Pack	Labels per Pack
980014	L7123	Rectangle	White	80 x 35mm	14	10	140
980013	L7109	Rectangle	White	62 x 42mm	18	10	180

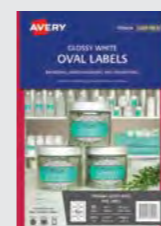

### Glossy Oval Laser / Inkjet Labels

- Ideal for creating high quality branded labels for your products
- Permanent adhesive works on glass, plastic and paper, so it can be used on a variety of product packaging
- Customise your labels with our free and easy-to-use template software; Avery Design and Print – available at [averyproducts.com.au/print](http://averyproducts.com.au/print)
- Print-to-the-edge feature lets you create a custom look to showcase your product, logo or company
- Print labels for your product in the quantity you need, when you need them



Code	Software Code	Description	Colour	Size	Labels per Sheet	Sheets per Pack	Labels per Pack
980012	L7127	Oval	White	84.7 x 50.8mm	8	10	80
980000	L7102	Oval	White	63.5 x 42.3mm	18	10	180



### White Glossy Round Laser / Inkjet Labels

- Durable glossy finish gives products, packaging and your brand a premium look and feel
- Permanent adhesive works on a variety of product packaging such as glass
- Customise your labels with our free and easy-to-use template software; Avery Design and Print – available at [averyproducts.com.au/print](http://averyproducts.com.au/print)
- Print-to-the edge feature lets you apply bold colours and sharp clear text to the edge of the label
- Ideal size for packaging lids, envelopes and seals



Code	Software Code	Description	Colour	Size	Labels per Sheet	Sheets per Pack	Labels per Pack
980001	L7105	Round	White	60mm diameter	12	10	120
980052	L7147	Round	White	40mm diameter	24	10	240

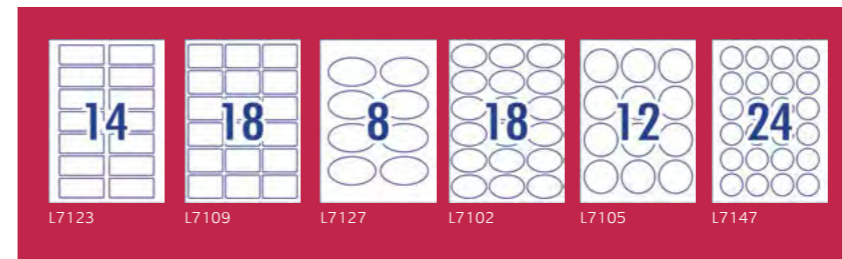

*Did you know?*  
Choosing colour over black and white wins every time. Select colours that stand out, not only against your own packaging but against that of your competitors too.



## White Glossy Square Laser / Inkjet Labels

- The glossy finish gives products, packaging and your brand a premium look and feel
- Add bold colours and sharp text onto your label to show off your brand
- Customise your labels with our free and easy-to-use template software; Avery Design and Print – available at [averyproducts.com.au/print](http://averyproducts.com.au/print)
- Permanent adhesive is perfect for glass, plastic, paper and more



Code	Software Code	Description	Colour	Size	Labels per Sheet	Sheets per Pack	Labels per Pack
980016	L7124	Square	White	45 x 45mm	20	10	200
980015	L7119	Square	White	35 x 35mm	35	10	350

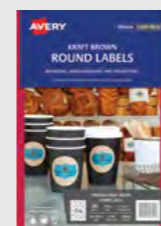

## Kraft Brown Laser / Inkjet Labels

- Available in rectangle, round, oval and wraparound shapes they are ideal for creating high quality branded labels for your products
- Kraft Brown labels provide a natural look for showcasing your brand, logo or product
- Made from 100% recycled material
- Customise your labels with our free and easy-to-use template software; Avery Design and Print – available at [averyproducts.com.au/print](http://averyproducts.com.au/print)



Code	Software Code	Colour	Size	Labels per Sheet	Sheets per Pack	Labels per Pack
<b>Round</b>						
980002	L7106	Kraft Brown	60mm diameter	12	15	180
<b>Wraparound</b>						
980051	L7145	Kraft Brown	190 x 16mm	12	15	180
<b>Rectangle</b>						
980017	L7110	Kraft Brown	62 x 42mm	18	15	270
<b>Oval</b>						
980018	L7103	Kraft Brown	63.5 x 42.3mm	18	15	270

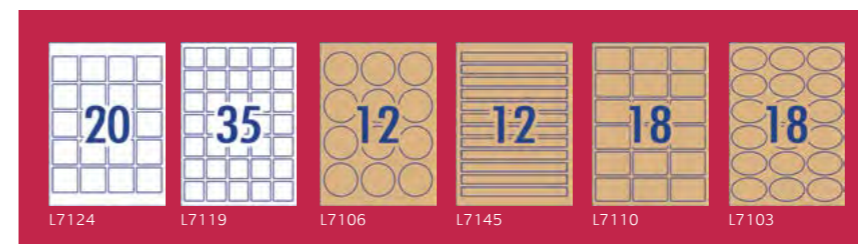

### Did you know?

The larger your label the greater the likelihood of it standing out. Add bold lines, borders and stripes also mean that your label could be viewed 42% more than any neighbouring plain labels.

### Removable Laser / Inkjet Labels

- Removable labels stick securely on products or packaging material and can be removed without leaving any residue
- Developed for products and materials where pricing and product information is removed after the sale
- Customise your labels with our free and easy-to-use template software; Avery Design and Print – available at [averyproducts.com.au/print](http://averyproducts.com.au/print)
- Perfect for giftware, glassware, candles and jars
- Perfect for gift shops where pricing is removed before gift wrapping









Code	Software Code	Colour	Size	Labels per Sheet	Sheets per Pack	Labels per Pack
<b>Round</b>						
980009	L7104REV	White	60mm diameter	12	10	120
<b>Rectangle</b>						
980011	L7108REV	White	62 x 89mm	9	10	90
980010	L7107REV	White	62 x 42mm	18	10	180
<b>Oval</b>						
980008	L7101REV	White	63.5 x 42.3mm	18	10	180

### Crystal Clear Laser Labels

- 100% transparent labels add a professional, printed-on look to your products. Labels are water, oil and dirt resistant
- Customise your labels with our free and easy-to-use template software; Avery Design and Print – available at [averyproducts.com.au/print](http://averyproducts.com.au/print)
- Permanent adhesive is perfect for glass, plastic and paper
- Ideal for use on jars and bottles containing oils

Code	Software Code	Colour	Size	Labels per Sheet	Sheets per Pack	Labels per Pack
<b>Rectangle</b>						
980019	L7113	100% Transparency	96 x 50.8mm	10	10	100
<b>Round</b>						
980022	L7114	100% Transparency	60mm diameter	12	10	120
<b>Square</b>						
980021	L7126	100% Transparency	45 x 45mm	20	10	200

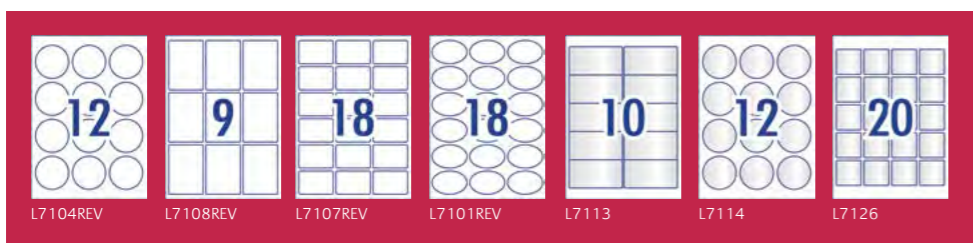

### Durable Glossy Laser Labels

- Water-resistant, oil-resistant, scuff and tear-resistant
- Print-to-the-edge feature lets you apply bold colours and sharp clear text on the whole label
- Customise your labels with our free and easy-to-use template software; Avery Design and Print – available at [averyproducts.com.au/print](http://averyproducts.com.au/print)
- Permanent adhesive works on a variety of product packaging such as glass, plastics and paper





Code	Software Code	Colour	Size	Labels per Sheet	Sheets per Pack	Labels per Pack
<b>Wraparound</b>						
980053	L7146	White	196 x 51mm	6	10	60
<b>Rectangle</b>						
980054	L7148	White	96 x 51mm	10	10	100

### Arched Water Resistant Laser Labels

- Water-resistant labels that are perfect for liquid products or products that are chilled or refrigerated
- Permanent adhesive works on glass, plastic, metal and paper
- Customise your labels with our free and easy-to-use template software; Avery Design and Print – available at [averyproducts.com.au/print](http://averyproducts.com.au/print)
- High quality, textured label with an unusual shape helps your brand stand out. Ideal for use on products that will be kept in refrigerators





Code	Software Code	Colour	Size	Labels per Sheet	Sheets per Pack	Labels per Pack
<b>Wraparound</b>						
980023	L7128	White Textured	89 x 120.7mm	4	10	40
980003	L7118	White Textured	57.2 x 77mm	9	10	90

*Did you know?*

The use of a handwriting font can increase customer considerations by 30% and purchase intentions by 33%.

*Did you know?*



Labels that included a product signifier (like a bee on a pot of honey) made products much easier to find and made people look at the product for longer.

## Retail Solutions



### With Compliments Cards

- Ideal for promoting your business with your product deliveries
- Made from quality cardstock
- Customise your cards with our free and easy-to-use template software; Avery Design and Print – available at [averyproducts.com.au/print](http://averyproducts.com.au/print)
- Double sided printing allows plenty of space for information and promotional messages
- Smooth edges give a professional finish





Code	Software Code	Description	Colour	Size	Labels per Sheet	Sheets per Pack	Labels per Pack
980027	C32295	Rectangle	White	□ 210 x 99mm	3	10	30



### Round Display Card Removable Laser / Inkjet

- Unique round shape to give your display a modern, professional look
- Strong adhesive is perfect for outdoor use
- Customise your cards with our free and easy-to-use template software; Avery Design and Print – available at [averyproducts.com.au/print](http://averyproducts.com.au/print)
- Special adhesive technology sticks to most surfaces including tiles, glass and polyester tablecloths



Code	Software Code	Description	Colour	Size	Labels per Sheet	Sheets per Pack	Labels per Pack
980049	16153	Round	White	□ 104 x 108mm	4	8	32



### Shelf Talker Removable Laser

- High quality paper material that is durable and hold rich colours and sharp text you need
- Removable adhesive allows repositioning of talkers several times without sacrificing adhesive performance
- Customise your shelf-talkers with our free and easy-to-use template software; Avery Design and Print – available at [averyproducts.com.au/print](http://averyproducts.com.au/print)
- Print-to-the-edge feature lets you add full colour background to the shelf talker







Code	Software Code	Description	Colour	Size	Labels per Sheet	Sheets per Pack	Labels per Pack
980047	C32301	Rectangle	White	□ 55 x 85mm	6	5	30



### Did you know?

Remembering to include product or business awards or accreditation can improve considerations by 25%, positive impressions by 36% and quality perceptions by 53%. It can even encourage the customer to pay more.



### Printable Tags with String

- Double-sided printing with room for logo, messaging, pricing or barcode
- Includes prepunched holes and premium-style fabric string with a quick-latch fastener for easy and secure attachment
- Customise your tags with our free and easy-to-use template software; Avery Design and Print – available at [averyproducts.com.au/print](http://averyproducts.com.au/print)
- High quality durable card



Code	Software Code	Description	Colour	Size	Labels per Sheet	Sheets per Pack	Labels per Pack
980050	22848	Scallop	White	□ 50 x 32mm	18	8	90



### Pricing Removable Laser Labels

- Ideal size for pricing, logo, product information and more
- Print-to-the-edge feature lets you add a full-colour background to the label
- Customise your labels with our free and easy-to-use template software; Avery Design and Print – available at [averyproducts.com.au/print](http://averyproducts.com.au/print)
- Removable adhesive that sticks securely to products or packaging
- Jam Free™ reliability for trouble-free printing, saving time and minimising wastage





Code	Software Code	Colour	Size	Labels per Sheet	Sheets per Pack	Labels per Pack
Round						
910007	 L7129	White	□ 40mm Diameter	24	8	192
Rectangle						
910009	L7144	White	□ 37.1 x 21.2mm	65	8	520

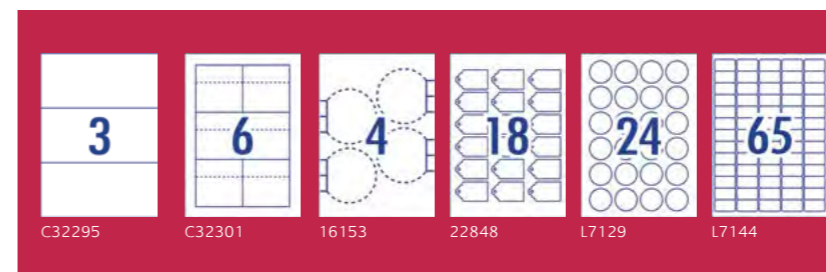





8	10
C32015 C32028	C32011 L7414 C32016 L7415 C32026 IJ39 IJ37



## Quick & Clean™ Business Cards – Laser / Inkjet

- Durable heavy weight material to ensure you make the right impression
- Quick & Clean™ separates easily with smooth and clean edges
- Customise your Business Cards with our free and easy-to-use template software; Avery Design and Print – available at [averyproducts.com.au/print](http://averyproducts.com.au/print)
- Cards are instantly available, saving you time
- Save money by only printing the number of cards you need



Code	Software Code	Colour	Size	Labels per Sheet	Sheets per Pack	Cards per Pack
<b>Matt Finish</b>						
936220	C32015	White double sided	85 x 54mm	8	25	200
959078	C32011	White	85 x 54mm	10	25	250
<b>Satin Finish</b>						
959079	C32016	White print double sided	85 x 54mm	10	25	250
936230 <b>BEST SELLER</b>	C32026	White print double sided	85 x 54mm	10	10	100



## Quick & Clean™ Business Card Inkjet

- High quality gloss coating on the front with a matt finish back to write important appointments and dates
- Quick & Clean™ separates easily with smooth and clean edges
- Customise your Business Cards with our free and easy-to-use template software; Avery Design and Print – available at [averyproducts.com.au/print](http://averyproducts.com.au/print)
- Clean, smooth edges for a professional finish
- Save money by only printing the number of cards you need



Code	Software Code	Colour	Size	Labels per Sheet	Sheets per Pack	Cards per Pack
<b>Gloss Finish</b>						
936229	C32028	White print double sided	85 x 54mm	8	10	80



## Matt Finish Business Cards Laser / Inkjet

- Micro-perforated sheets allow you to easily separate each business card
- Print as many cards as you need when you need them
- Customise your Business Cards with our free and easy-to-use template software; Avery Design and Print – available at [averyproducts.com.au/print](http://averyproducts.com.au/print)
- Design and print your own business cards within minutes direct from your home or office printer
- Save money by only printing the number of cards you need



Code	Software Code	Colour	Size	Labels per Sheet	Sheets per Pack	Cards per Pack
<b>Matt Finish</b>						
959025	L7414	White	90 x 52mm	10	20	200
959026 <b>BEST SELLER</b>	L7415	White	90 x 52mm	10	100	1000



## Matt Leathergrain Finish Business Card Inkjet

- Save money by only printing the number of cards you need
- Design and print your own business cards within minutes direct from your home or office printer
- Customise your Business Cards with our free and easy-to-use template software; Avery Design and Print – available at [averyproducts.com.au/print](http://averyproducts.com.au/print)
- Micro-perforated sheets allow you to easily separate each business card
- Premium leathergrain finish is optimized for vibrant colours and sharp text

Code	Software Code	Colour	Size	Labels per Sheet	Sheets per Pack	Cards per Pack
<b>Matt Finish</b>						
70450	IJ39	White	90 x 52mm	10	20	200



## Gloss White Magnetic Business Cards Inkjet

- Sticks to most metal surfaces to keep them displayed, which is great for getting repeat business
- Clean, smooth edges for a professional finish
- Customise your Business Cards with our free and easy-to-use template software; Avery Design and Print – available at [averyproducts.com.au/print](http://averyproducts.com.au/print)
- Specially coated for sharp text and vivid colours
- Strong magnetic holds without adhesive for easy repositioning

Code	Software Code	Colour	Size	Labels per Sheet	Sheets per Pack	Cards per Pack
<b>Gloss Finish</b>						
71019	IJ37	White	90 x 52mm	10	10	100

# Home



These labels are perfect for use in any room throughout your home such as the kitchen, pantry, storage and kid's rooms.

Locate your kids' belongings with our brightly coloured labels or get creative by making personalised magnets and your own t-shirt designs. Bring your creations to life using our FREE template software available at Avery Design & Print.



**A5 Printable Organisation & Storage Labels**  
Laser / Inkjet

- Premium linen material that is water-resistant
- Compatible with Laser and Inkjet printers
- Customise your labels with our free and easy-to-use template software; Avery Design and Print – available at [averyproducts.com.au/print](http://averyproducts.com.au/print)
- Print-to-the-edge for a full colour, professional looking finish
- Permanent adhesive sticks to multiple surfaces such as glass, plastic and paper

FREE TEMPLATES  
Avery Design & Print

MADE IN AUSTRALIA



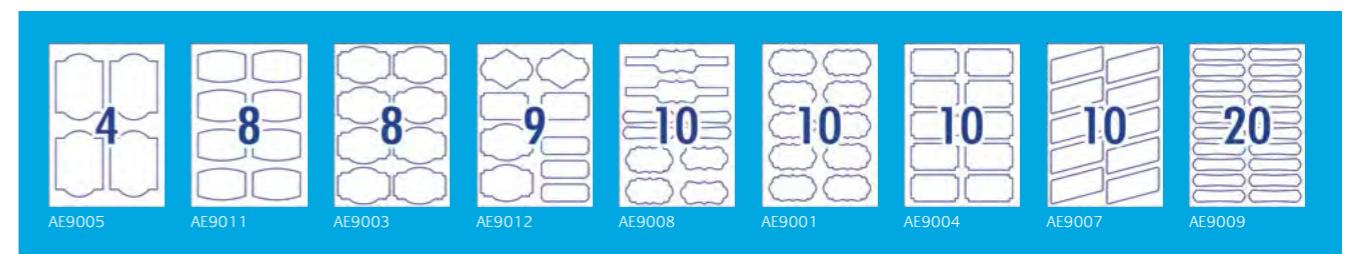







Code	Software Code	Colour	Size	Shape	Labels per Sheet	Sheets per pack	Labels per Pack
AE9005	AE9005	White (Blank)	60 x 84mm		4	4	16
AE9011	AE9011	White (Blank)	60 x 40mm		8	4	32
AE9003	AE9003	White (Blank)	66 x 46.5mm		8	4	32
AE9012	AE9012	White (Blank)	Assorted		9	4	36
AE9008	AE9008	White (Blank)	Assorted		10	4	40
AE9001	AE9001	White (Blank)	60 x 34mm		10	4	40
AE9004	AE9004	White (Blank)	60 x 34mm		10	4	40
AE9007	AE9007	White (Blank)	66 x 46mm		10	4	40
AE9009	AE9009	White (Blank)	66 x 15mm		20	4	80





### A6 Durable Home / Kitchen / Storage Labels



- Labels are freezer, dishwasher and microwave safe
- Made from durable material that is water and temperature resistant
- Hand Writable labels for quick and convenient identification
- Removable adhesive leaves no residue so you reuse containers

Code	Description	Colour	Size	Labels per Sheet	Sheets per pack	Labels per Pack
39014	Durable Rectangle	White with Floral Design 	95.2 x 63.5mm	2	5	10
39015	Durable Rectangle	White with Butterfly Design 	44.4 x 25.4mm	10	5	50
39016	Durable Rectangle	White with Green Border 	95.2 x 63.5mm	2	5	10
39017	Durable Rectangle	White with Brown Details 	95.2 x 63.5mm	10	5	50
39020	Durable Rectangle	White with Blue Details 	44.4 x 31.7mm	8	4	32
39021	Durable Rectangle	White with Green Details 	44.4 x 31.7mm	8	5	40
39027	Durable Round	White with Assorted Colour 	45mm Diameter	24	4	96
39028	Durable Square	White with Assorted Colour 	45 x 45mm	24	4	96
39029	Durable Rectangle	White Assorted Border 	70 x 40mm	4	4	16
39030	Durable Rectangle	White Assorted Colours 	91 x 68mm	2	4	8



### A6 Kraft Brown Writable Home Labels



- Writable labels for quick and easy identification
- Labels stick and stay securely and remove cleanly, without leaving residue
- Kraft brown in colour for a natural and earthy aesthetic look

Code	Description	Colour	Size	Labels per Sheet	Sheets per pack	Labels per Pack
39031	Multi Use Round	Kraft Brown 	70mm Diameter	2	4	8
39013	Scallop Shape	Kraft Brown 	57.1 x 28.6mm	4	6	24



### A6 Rewritable Home Labels

- Labels are made from dry erase material, so you can write, erase and write again
- Ideal for use on storage bins, boxes, glass and more
- Labels stick and stay securely and remove cleanly, without leaving residue
- Use with dry erase whiteboard markers

Code	Description	Colour	Size	Labels per Sheet	Sheets per pack	Labels per Pack
39018	Rewritable Rectangle	White with Blue Details 	88.9 x 31.7mm	4	4	16
39019	Rewritable Rectangle	White with Green Details 	88.9 x 31.7mm	4	4	16



### A6 Storage labels

- Writable labels for quick and convenient identification
- Ideal for use on storage bins, boxes, glass and more
- Labels stick and stay securely and remove cleanly, without leaving residue





Code	Description	Colour	Size	Labels per Sheet	Sheets per pack	Labels per Pack
39012	Multi Use Square	White with Butterfly Design 	38.1 x 38.1mm	6	6	36





### Chalkboard Organisation Labels

- Hand Writable labels for quick and convenient identification
- Made from durable material that is water and temperature resistant
- Labels are freezer, dishwasher and micro-wave safe
- Removable adhesive leaves no residue so you reuse containers
- Ideal for containers with ever changing contents





Code	Description	Colour	Size	Labels per Sheet	Sheets per Pack	Labels per Pack
39103	Chalkboard Rectangle	Black 	132 x 88mm	1	4	4
39102	Chalkboard Rectangle	Black 	95 x 45mm	3	4	12
39100	Chalkboard Round	Black 	70mm Diameter	8	4	32
39101	Chalkboard Scallop	Black 	95 x 45mm	12	4	48





### Fridge Magnets

- Create your own fridge magnets
- Fridge Magnets are compatible with Inkjet printers
- Customise your magnets with our free and easy-to-use template software; Avery Design and Print – available at [averyproducts.com.au/print](http://averyproducts.com.au/print)
- A4 sheets can be cut into shaped or different sizes
- Perfect for fridges or magnetic notice boards

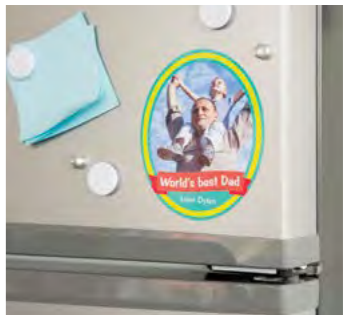

Code	Software Code	Colour	Size	Quantity per Sheet	Sheets per Pack	Quantity per Pack
71021	C9415	White 	210 x 297mm	1	3	3
79023	C9415	White 	210 x 297mm	1	30	30



### Adhesive Pockets

- Insert pocket allows for quick change of card whenever needed
- Adhesive pockets stick to a variety of surfaces
- Writable cardstock for quick and easy identification
- Convenient A6 pack for home use, so there's no wastage



Code	Description	Colour	Size	Labels per Sheet	Sheets per Pack	Labels per Pack
39024	Adhesive Pocket & Inserts	Clear with Green details	Insert 50.8 x 88.9mm Pocket 58.4 x 95.2mm	2	3	6

### Cord Tags

- Hand Writable labels for quick and convenient identification
- Ideal for identifying and organising your electrical and other cords
- Made from durable material that is resistant to water, hot and cold temperatures
- Convenient A6 pack for home use, so there's no wastage
- Labels stick and stay securely and remove cleanly, without leaving residue



Code	Description	Colour	Size	Labels per Sheet	Sheets per Pack	Labels per Pack
39032	White Rectangle	White	40 x 60mm	24	4	96

### Self Laminating Labels

- Hand-write on the label, then seal with the adhesive laminate
- Made from durable material that is water and temperature resistant
- Wipeable: you can clean the surface of the label with a damp cloth or a household cleaner
- Convenient A6 pack for home use, so there's no wastage



Code	Description	Colour	Size	Labels per Sheet	Sheets per Pack	Labels per Pack
39034	White Rectangle	White with Grey Border	95 x 70mm	2	4	8
39033	White Rectangle	White with Grey Border	85 x 17mm	6	4	24

### No Iron Clothing Labels Handwritable

- Just write, peel and stick - no iron required
- Perfect for labelling jackets, t-shirts, hats, backpacks and more
- Labels withstand multiple washing machine and dryer cycles
- Permanent adhesive – Work best with permanent markers
- Allow label to set for 24 hours prior to washing
- Convenient A6 pack for home use, so there's no wastage



Code	Description	Colour	Size	Labels per Sheet	Sheets per Pack	Labels per Pack
40700	Assorted Shapes Permanent	White	Assorted	15	3	45
40720	Fabric Labels Permanent	White	45 x 13mm	18	3	54

### Durable Labels Handwritable

- Dishwasher and microwave safe
- Labels stick to plastic, wood, metal, rubber, paper, ceramic and glass
- Labels are guaranteed to cover over anything underneath
- Work best with permanent markers



Code	Description	Colour	Size	Labels per Sheet	Sheets per Pack	Labels per Pack
41413	Permanent	Assorted (Blue & Green Border)	89 x 32mm	4	5	20
41440	Permanent	Assorted (Blue, Red & Green Border)	89 x 16mm	7	5	35
41441	Permanent	Assorted (Blue, Red & Green Border)	44 x 19mm	12	5	60

### T Shirt Transfer – Inkjet

- Design your own t-shirts using photos, logos, text and more
- Available in both clear and white transfer options for use on light and dark coloured t-shirts
- Customise your transfers with our free and easy-to-use template software; Avery Design and Print – available at [averyproducts.com.au/print](http://averyproducts.com.au/print)
- Ideal for when you need a personalised t-shirt such as events, gifts and more
- Easy to use with instructions in pack

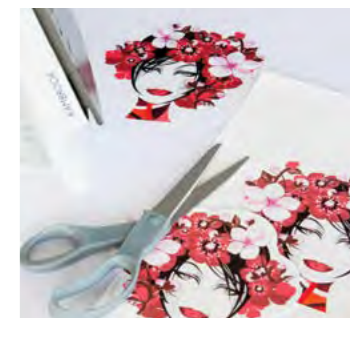

Code	Software Code	Description	Size	Labels per Sheet	Sheets per Pack	Labels per Pack
70580	C9414	White T Shirt Transfer	297 x 210mm	1	1	5
79009	C9414	Dark Colour T Shirt Transfer	297 x 210mm	1	1	5

## Did you know?

Keep your kids' clothing out of the lost-and-found with our No-Iron Clothing Labels - all you need to do is write, peel and stick! It's that easy.

# Celebrations & Parties



Do you have a celebration or a party coming up?  
Are you wanting to stand out from the crowd  
and create that lasting impression?

Avery has you covered with a range that will be sure to make your celebration a success. With FREE template software available at Avery Design & Print you can create invites to place cards to gloss and clear labels so your party will have it all!

### Glossy White Labels Laser / Inkjet

- Premium quality glossy white labels to display your individual designs
- Compatible with both Laser and Inkjet printers
- Customise your labels with our free and easy-to-use template software; Avery Design and Print – available at [averyproducts.com.au/print](http://averyproducts.com.au/print)
- Print-to-the-edge labels provide a full colour, professional finish
- Permanent adhesive sticks to multiple surfaces like glass, metal, paper and plastic

Code	Software Code	Description	Colour	Size	Labels per Sheet	Sheets per Pack	Labels per Pack
982506	L7270	Round	White	60mm	12	5	60
982507	L7271	Oval	White	63.5 x 42.3mm	18	5	90

### Crystal Clear Labels Laser

- 100% transparent, glossy, durable material is oil, dirt, splash and tear proof
- Permanent adhesive sticks to multiple surfaces like glass, metal, paper and plastic
- Customise your labels with our free and easy-to-use template software; Avery Design and Print – available at [averyproducts.com.au/print](http://averyproducts.com.au/print)
- Print-to-the-edge labels provide a full colour, professional finish

Code	Software Code	Description	Colour	Size	Labels per Sheet	Sheets per Pack	Labels per Pack
982509	L7273	Square	Crystal Clear	45 x 45mm	20	5	100

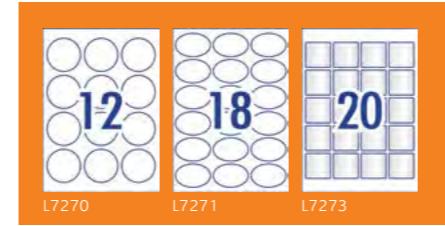

### Card Products Laser / Inkjet

- Matt white heavyweight card provides an optimal base for vivid graphics and sharp text
- Compatible with both Laser and Inkjet printers. Easy customisable with our free and easy-to-use template software; Avery Design and Print – available at [averyproducts.com.au/print](http://averyproducts.com.au/print)
- Save money by printing only the amount you need



Code	Software Code	Description	Colour	Size	Labels per Sheet	Sheets per Pack	Labels per Pack
982501	C2360	DL Invitations	White	210 x 99mm	3	10	30
982502	C2319	Postcards	White	128 x 82mm	4	10	40
982503	C32073	Folded Placecards	White	85 x 50mm (folded)	4	10	40
982504	C32072	Placecards	White	85 x 54mm	8	5	40

### Pearlised Labels Laser / Inkjet

- Print-to-the-edge for a full colour, professional finish
- Compatible with both laser and inkjet printers
- Customise your labels with our free and easy-to-use template software; Avery Design and Print – available at [averyproducts.com.au/print](http://averyproducts.com.au/print)
- Permanent adhesive sticks to multiple surfaces like glass, metal, paper and plastic



Code	Software Code	Description	Colour	Size	Labels per Sheet	Sheets per Pack	Labels per Pack
982516	L7281	Rectangle	White	64 x 30.5mm	24	5	120

### White Textured Labels Laser / Inkjet

- Permanent adhesive sticks to multiple surfaces like glass, metal, paper and plastic
- Compatible with both laser and inkjet printers
- Customise your labels with our free and easy-to-use template software; Avery Design and Print – available at [averyproducts.com.au/print](http://averyproducts.com.au/print)
- Print-to-the-edge for a full colour, professional finish



Code	Software Code	Description	Colour	Size	Labels per Sheet	Sheets per Pack	Labels per Pack
982510	L7275	Arch	White	89 x 120.7mm	4	5	20
982520	L7285	Rectangle Wraparound	White	200 x 44.5mm	6	5	30
982518	L7283	Scallop	White	60mm diameter	12	5	60

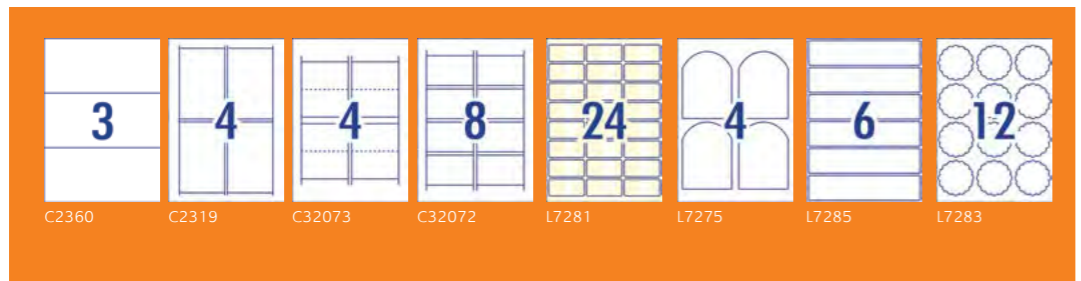

### Matt White Address Labels Kit Laser / Inkjet

- Premium quality matt white label material provides vivid colour and sharp text for brilliant high resolution colour images
- Compatible with Laser and Inkjet printers
- Customise your labels with our free and easy-to-use template software; Avery Design and Print – available at [averyproducts.com.au/print](http://averyproducts.com.au/print)
- Quick Peel Pop-up Edge allows for quicker and easier detachment of labels from backing sheet
- Label pack contains both Address and Return address label sizes

Code	Software Code	Description	Colour	Size	Labels per Sheet	Sheets per Pack	Labels per Pack
982512	L7276 and L7277	Rectangle	White	99.1 x 34mm and 38.1 x 21.2mm	16 & 65	8 & 2	258

### Crystal Clear Address Labels Kit Laser

- Matt white heavyweight card provides an optimal base for vivid graphics and sharp text
- Compatible with both Laser and Inkjet printers
- Easy customisable with our free and easy-to-use template software; Avery Design and Print – available at [averyproducts.com.au/print](http://averyproducts.com.au/print)
- Save money by printing only the amount you need

Code	Software Code	Description	Colour	Size	Labels per Sheet	Sheets per Pack	Labels per Pack
982513	L7278 and L7279	Rectangle	Crystal Clear	99.1 x 34mm and 38.1 x 21.2mm	16 & 65	8 & 2	258

### Party Bag Kit Laser / Inkjet

- Created personalised party bags, invitations and party decorations to match your theme
- Ideal for birthdays, parties and special events
- Customise your labels with our free and easy-to-use template software; Avery Design and Print – available at [averyproducts.com.au/print](http://averyproducts.com.au/print)

Code	Software Code	Description	Colour	Size	Labels per Sheet	Sheets per Pack	Labels per Pack
982511	L7272	20 Clear Bags & 20 Bag Toppers	Crystal Clear	48 x 137mm	4	5	20
982522	Various	Consist: Arch Label, Folded Placecard, DL Invitations, Oval Labels, Party Bag Kit, Address & Return Labels for up to 20 Guests	White	Various		27 Assorted Sheets	Various





### Kraft Brown Labels Laser / Inkjet

- Kraft brown labels are the perfect way to add an earthy, natural look to your gifts and party favours
- Made from recycled material
- Customise your labels with our free and easy-to-use template software; Avery Design and Print – available at [averyproducts.com.au/print](http://averyproducts.com.au/print)
- Print-to-the-edge labels provide a full colour, professional finish
- Permanent adhesive sticks to multiple surfaces like glass, metal, paper and plastic



Code	Software Code	Description	Colour	Size	Labels per Sheet	Sheets per Pack	Labels per Pack
982508	L7274	Round	Kraft Brown	60mm diameter	12	5	60



## Looking to reward kids at home or in the classroom?

A fantastic range of bright, fun merit stickers for teachers and parents to reward good behaviour at home or in the classroom. We also offer certificates and merit ribbons that will have them aspiring for more!

## Merit Stickers

- Perfect for teachers or parents wanting to reward good behaviour
- Bright, colourful designs that kids will aspire to collect

Code	Description	Size	Labels per Pack	Designs per Pack
69633	Principal's Award	30mm	102	1
69634	Happy Birthday	30mm	102	1
69610	Googly Eyes	30mm	100	4
69619	Smiley Faces	43mm	102	4
69604	Farm Animals	30mm	50	6
69606	Wow Stars	45mm	50	6
69602	Star Face	30mm	50	6
69605	Australian Art	30mm	50	6
69645	Scratch and Sniff	30mm	72	6
69601	Australian Animals	30 mm	96	6
69607	Bright	30mm	96	6
69614	Paint Splats	30mm	96	6
69617	3D Stars	30mm	96	6
69615	Super Stars	30mm	100	6
69621	Cartoon Band	30mm	102	6
69639	Dazzling Stars	30mm	102	6
69624	Caption Shapes	18 x 30mm	120	6
69623	Multiple Captions	22mm	200	6
69622	Mini Brights	14mm	800	6
69618	Mini Smiley Faces	13mm	800	20
69620	Mini Assortment	13mm	800	20



Principal's Award	Happy Birthday	Googly Eyes	Smiley Faces	Farm Animals	Wow Stars	Star Face
Australian Art	Scratch and Sniff	Australian Animals	Bright	Paint Splats	3D Stars	Super Stars
Cartoon Band	Dazzling Stars	Caption Shapes	Multiple Captions	Mini Brights	Mini Smiley Faces	Mini Assortment

## NEW Kids Labels

Label all your back to school needs with labels that will last. Available late September 2018.

- Perfect for pen/pencils, rulers, books, water bottles, lunch boxes and so much more!
- Durable Water-resistant label with strong adhesive.
- Dishwasher and Microwave Safe.
- Works best with permanent markers.
- Label adheres to plastic, wood, metal, rubber, paper, ceramic and glass.
- 42 Labels / 3 Sheets
- Assorted shapes and sizes



Code	Description	Pack Contents
41418	Hello it's me Durable School Label Multipack PK3	Each sheet contains: <ul style="list-style-type: none"> <li>• 2 x large name stickers: 25 x 50mm</li> <li>• 4 x medium name stickers: 15 x 45mm</li> <li>• 2 x square name stickers: 35 x 35mm</li> <li>• 6 x Mini Pen stickers: 42 x 7mm</li> </ul>
41419	Love Dream Shine Durable School Label Multipack PK3	Each sheet contains: <ul style="list-style-type: none"> <li>• 2 x large name stickers: 25 x 50mm</li> <li>• 4 x medium name stickers: 15 x 45mm</li> <li>• 2 x square name stickers: 35 x 35mm</li> <li>• 6 x Mini Pen stickers: 42 x 7mm</li> </ul>





### Print your Own Merit Stickers

- Printable merit awards that you can make as individual as your students
- Customise your merits with our free and easy-to-use template software; Avery Design and Print – available at [averyproducts.com.au/print](http://averyproducts.com.au/print)
- Perfect for teachers rewarding school children





Code	Software Code	Description	Size	Labels per Pack	Sheets per Pack	Labels per Sheet
69703	C2423	Print Your Own Merit Stickers	40mm diameter	240	10	24

### Ribbons

- Perfect for teachers rewarding school children in athletic or academic events
- Premium Satin ribbon fabric and gold print



Code	Description	Colour	Size	Ribbons per Pack
69629	1st Place	Blue	150 x 35mm	100
69630	2nd Place	Red	150 x 35mm	100
69631	3rd Place	Yellow	150 x 35mm	100
69632	4th Place	Green	150 x 35mm	100

### Certificates

- Assorted pack of 2 mixed designs
- Perfect for teachers rewarding school children
- Bright, colourful designs that kids will aspire to collect



Code	Description	Size	Certificates per Pack
69644	Student of the Week	148 x 210mm	36
69646	Happy Birthday	148 x 210mm	36



# Filing & Dividers

Our range of files, fasteners, dividers and title labels will help you to stay organised & provide colour coded options to suit your needs.

Minimise clutter and simply your life, whether you're in the office, at home or school, by using Avery manilla folders and dividers which are strong and versatile. Add a fastener so that your documents are secure and file title labels for a professional finish.

## Filing Folder Dimensions and Weights Guide

DIMENSIONS	
A4	320 x 241mm
Foolscap	355 x 241mm
Legal	388 x 241mm



  

WEIGHTS	
Standard	163 – 192gsm
Heavy Weight	240 – 250gsm
Extra Heavyweight	300 – 325gsm
Super Weight	370 – 380gsm



### Buff Manilla File

- Avery manilla files offer the highest quality from a strong and durable manilla board
- Ideal for projects or personal files and suitable for compact archiving into storage systems
- Available in a range of other colours and in foolscap and A4 sizes

Code	Colour	Size	Box
82703	Buff	A4	20
88055	Buff	A4	50
81702 <b>BEST SELLER</b>	Buff	A4	100
88051	Buff	Foolscap	10
88200	Buff	Foolscap	20
88225	Buff	Foolscap	25
88050	Buff	Foolscap	50
81502 <b>BEST SELLER</b>	Buff	Foolscap	100
88160	Buff Extra Heavyweight	Foolscap	10
81504	Buff Extra Heavyweight	Foolscap	100



### Coloured Manilla Files

- Avery manilla files offer the highest quality from a strong and durable manilla board
- Ideal for projects or personal files and suitable for compact archiving into storage systems
- Available in a wide range of colours and in foolscap or A4 size



Code	Colour	Size	Box
83712	Red	A4	10
83722	Blue	A4	10
83742	Yellow	A4	10
82723	Blue	A4	20
82713	Red	A4	20
82733	Green	A4	20
82743	Yellow	A4	20
82753	Pink	A4	20
81712	Red	A4	100
81722	Blue	A4	100
81732	Green	A4	100
81742	Yellow	A4	100
81752	Pink	A4	100
88151 <b>BEST SELLER</b>	Assorted (Blue, Red, Green, Yellow)	Foolscap	10
88154	Black Heavyweight	Foolscap	10
88155	White Heavyweight	Foolscap	10
88150	Assorted (Blue, Red, Green, Yellow)	Foolscap	20
88212	Red	Foolscap	20
88222	Blue	Foolscap	20
88229	Grey	Foolscap	20
88232	Green	Foolscap	20
88242	Yellow	Foolscap	20
88252	Pink	Foolscap	20
88272	Orange	Foolscap	20
88282	Light Blue	Foolscap	20
88292	Purple	Foolscap	20
81512	Red	Foolscap	100
81522 <b>BEST SELLER</b>	Blue	Foolscap	100
81529	Grey	Foolscap	100
81532	Green	Foolscap	100
81533	Light Green	Foolscap	100
81542	Yellow	Foolscap	100
81552	Pink	Foolscap	100
81572	Orange	Foolscap	100
81582	Light Blue	Foolscap	100
81592	Purple	Foolscap	100



### Tabbed Manilla Folders

- Manufactured from durable manilla board
- 5 tabs for easy identification
- Available in 5/pack or 50/pack



Code	Colour	Size	Box
81556	Buff (Fifth cut 1 set of 5)	Foolscap	5
81557	Buff (Fifth cut 10 sets of 5)	Foolscap	50



### Manilla Folders with White File Title Labels

- Add a professional look to your Avery manilla files by using your laser printer
- Ideal for projects or personal files and suitable for compact archiving into storage systems
- 20 manilla files, 1 sheet of 24 laser file title labels



Code	Colour	Size	Box
88300	Buff	Foolscap	20
88312	Red	Foolscap	20
88322	Blue	Foolscap	20
88350	Assorted (Blue, Red, Green, Yellow)	Foolscap	20



### Files with Fasteners – Permclip Files

- Extra heavy weight board fitted with a Permclip fastener
- Ideal for securing papers and adding pages to the top of the file
- Durable metal prongs of the fastener can be bent repeatedly



Code	Colour	Size	Box
85003	Buff	Foolscap	100
87003	Buff	A4	100

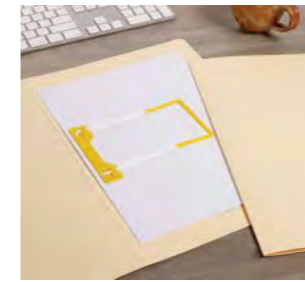

### Tubeclip Files – Plain No Print

- A long lasting, extra heavy weight board, with a Tubeclip fastener
- Ideal for projects or personal files and suitable for compact archiving into storage systems



Code	Colour	Size	Box
88551	Buff Plain	Foolscap	5
84505	Buff Plain	Foolscap	20



### Tubeclip Files – Buff with Coloured Print

- A long lasting, extra heavy weight board, with a Tubeclip fastener
- Ideal for projects or personal files and suitable for compact archiving into storage systems
- Available in buff with colour print for a classic look, or plain buff colour



Code	Colour	Size	Box
88552	Red Print	Foolscap	5
88553	Blue Print	Foolscap	5
88554	Green Print	Foolscap	5
84515	Red Print	Foolscap	20
84525	Blue Print	Foolscap	20
84535	Green Print	Foolscap	20

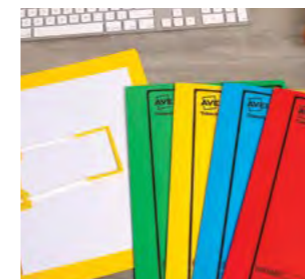

### Tubeclip Files – Solid Colour with Black Print

- A long lasting, extra heavy weight board, with a Tubeclip fastener
- Ideal for projects or personal files and suitable for compact archiving into storage systems
- Available in buff with colour print for a classic look, or coloured files with black print



Code	Colour	Size	Box
88412	Red File	Foolscap	5
88422	Blue File	Foolscap	5
88432	Green File	Foolscap	5
88442	Yellow File	Foolscap	5
88452	Assorted	Foolscap	5
84412	Red File	Foolscap	20
84422	Blue File	Foolscap	20
84432	Green File	Foolscap	20
84442	Yellow File	Foolscap	20



### Spiral Spring Action Files – Plain No Print

- Extra heavy duty file fitted with a spiral spring coil fastener and pressure plate
- Plain buff file, foolscap
- Secures documents to your file, so they do not fall out



Code	Colour	Size	Box
84504	Buff	Foolscap	25



### Spiral Spring Action Files – Buff with Coloured Print

- Extra heavy duty file fitted with a spiral spring coil fastener and pressure plate
- Allows you to easily add and remove pages from the top of the file
- Available in red, blue and black print



Code	Colour	Size	Box
86514	Red Print	Foolscap	25
86524 <small>BEST SELLER</small>	Blue Print	Foolscap	25
86534	Green Print	Foolscap	25



### Spiral Spring Action Files – Solid Colour with Black Print

- Extra heavy duty file fitted with a spiral spring coil fastener and pressure plate
- Available in buff, red, blue green and yellow with black print
- Secures documents to your file, so they do not fall out



Code	Colour	Size	Box
88544	Red	Foolscap	5
88545	Blue	Foolscap	5
88546	Green	Foolscap	5
88547	Yellow	Foolscap	5
88550	Assorted	Foolscap	5
85104	Red	Foolscap	25
85204 <small>BEST SELLER</small>	Blue	Foolscap	25
85304	Green	Foolscap	25
85404	Yellow	Foolscap	25



### Spiral Spring Transfer Solid Coloured Files with Black Print

- Efficient alternative to a lever arch file
- Two metal transfer prongs and corresponding coil springs creating an arch
- Documents are made accessible at any position in the file
- File expands as the number of pages inserted increase to minimise wasted space



Code	Colour	Size	Box
86804	Buff	Foolscap	25
86814	Red	Foolscap	25
86824	Blue	Foolscap	25
86834	Green	Foolscap	25



### Permclip File Fasteners

- Two pronged enamelled fastener with a self adhesive base
- Suitable for archiving and holding heavy documents
- Can be adhered to any file, perfect for securing documents
- Available in 20/box or 100/box for heavy usage



Code	Colour	Size	Box
80695	White	2 prong fastener	20
80699 <small>BEST SELLER</small>	White	2 prong fastener	100

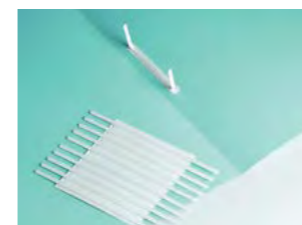

### Quickclip Fastener

- Adhesive on the base sticks to file and the 2 metal prongs bend up in order to add documents
- Ideal for presentation folders and slim files



Code	Colour	Size	Box
80692	White	2 prong fastener	50



### White Everfast Pin Holder

- Durable label designed for fixing split pins inside files
- Self adhesive material that is tear resistant
- Reinforce pins for durability



Code	Colour	Size	Box
81996	White printed Black	File Pin Holder	300

## Tubeclip File Fasteners

- Tubeclip 3 piece set comes with self adhesive base, a plastic 'U' piece and a plastic coloured compressor bar
- Suitable for securing documents that require easy access and frequent use
- Allows pages to be added or removed at any position within the file
- Easily attaches to Manilla Files and Lateral Files to ensure pages are secure

Code	Colour	Description	Box
44005B	Blue	3 Piece Set	10
44005R	Red	3 Piece Set	10
44005Y	Yellow	3 Piece Set	10
44009B	Blue	3 Piece Set	100
44009R	Red	3 Piece Set	100
44009Y	Yellow	3 Piece Set	100
44001	Yellow	3 Piece Set	500

- Ideal for permanent storage
- Require internal gusset inside file

Code	Colour	Description	Box
44021	White	3 Piece Set Non Adhesive	500

- Suitable for securing documents that require easy access and frequent use
- Allows you to re-use your U piece and pressure plates
- Comes in a convenient pack of 100

Code	Colour	Description	Box
44006	White	Adhesive Base	100
44007	White	Tube Only Non Adhesive	100

- A refill option to standard 3 piece set
- Available in yellow and blue colour

Code	Colour	Description	Box
44007B	Blue	U Piece only	25
44007Y	Yellow	U Piece only	25
44008B	Blue	Compressor Bar	25
44008Y	Yellow	Compressor Bar	25



## Print & Apply Clear Dividers Laser / Inkjet

- Translucent clear tab labels virtually disappear behind text
- Organise your documents quickly and easily
- Customise your tab labels with our free and easy-to-use template software; Avery Design and Print – available at [averyproducts.com.au/print](http://averyproducts.com.au/print)
- Simply print, align labels against tabs, smooth down labels and peel up strip



Code	Software Code	Colour	Description	Size
5111081	L7455-5	Clear	5 Tab	A4
5113081	L7455-10	Clear	10 Tab	A4



## Print & Apply White Dividers Laser / Inkjet

- Easy Apply labels allow you to apply all tab labels at once!
- Simply print, align labels against tabs, smooth down labels and peel up strip
- Customise your tab labels with our free and easy-to-use template software; Avery Design and Print – available at [averyproducts.com.au/print](http://averyproducts.com.au/print)
- Organise your documents quickly and easily



- Unpunched**
- Unpunched for use with wire and comb binding systems
- Extra Wide**
- Extra wide tabs

Code	Software Code	Colour	Description	Size
930111	L7455-5	White	5 Tab	A4
930112	L7455-6	White	6 Tab	A4
930113	L7455-10	White	10 Tab	A4
930114	L7455-12	White	12 Tab	A4
<b>Unpunched</b>				
930160	L7455-5	White	5 Tab	A4
930161	L7455-10	White	10 Tab	A4
<b>Extra Wide</b>				
930170	L7455-5	White	5 Tab	A4
930171	L7455-10	White	10 Tab	A4

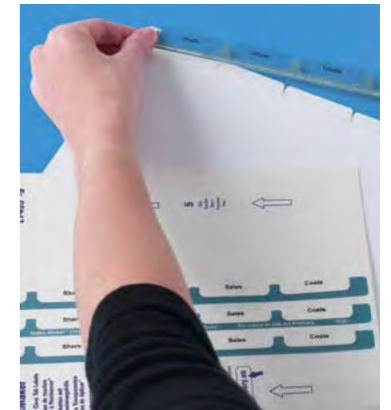

## Print & Apply Clear Dividers Laser / Inkjet - Bulk Pack

- Quickly print professional dividers directly from your printer
- Each pack consists of 5 sets of dividers
- Unpunched for use with wire and comb binding systems
- Customise your tabs & dividers with our free and easy-to-use template software; Avery Design and Print – available at [averyproducts.com.au/print](http://averyproducts.com.au/print)





Code	Software Code	Colour	Description	Size
16063	L7455-10	Clear	10 Tab (5 Sets)	A4



### Print On Dividers Laser / Inkjet

- Quickly print professional dividers directly from your printer
- Each pack consists of 4 sets of dividers, software and software guide
- Customise your tabs & dividers with our free and easy-to-use template software; Avery Design and Print – available at [averyproducts.com.au/print](http://averyproducts.com.au/print)





Code	Software Code	Colour	Description	Size
920192	L7420-5	White <input type="checkbox"/>	5 Tabs	A4
920193	L7420-8	White <input type="checkbox"/>	8 Tabs	A4



### Print On Tabs Removable Laser / Inkjet

- Self adhesive repositionable tabs
- Ideal for dividing and marking of specific pages or parts of pages in catalogues, bound documents, diaries, hanging file systems, reports, text books and more
- Customise your tabs with our free and easy-to-use template software; Avery Design and Print – available at [averyproducts.com.au/print](http://averyproducts.com.au/print)
- Attach to the edge of any size page





Code	Software Code	Colour	Description	Size
5412561	L7431	White <input type="checkbox"/>	48 Tabs	A4
5412501	L7431	Assorted <input checked="" type="checkbox"/>	48 Tabs	A4
5412548	L7431	Assorted <input checked="" type="checkbox"/>	Kit: 48 White, 48 Coloured Assorted	A4





### Style Edge Customisable Insert Tab Dividers Laser / Inkjet

- Stylish tab design keeps tabs from falling out
- Modern design and colours
- Customise your tabs with our free and easy-to-use template software; Avery Design and Print – available at [averyproducts.com.au/print](http://averyproducts.com.au/print)
- Easy access notch allows inserts to be rearranged or changed
- Thick, durable translucent plastic







Code	Software Code	Colour	Description	Size
87700	L7440-5	Clear <input checked="" type="checkbox"/>	5 Tab	A4
87701	L7440-10	Clear <input checked="" type="checkbox"/>	10 Tab	A4

## Dividers with Pre Printed Tabs



### Customisable Table of Contents – Brightly Coloured Tab Dividers Laser / Inkjet

- Simply flip the dividers and table of contents to use in landscape or portrait format depending upon your preference.
- Laser or inkjet compatible
- Customise your table of contents with our free and easy-to-use template software; Avery Design and Print – available at [averyproducts.com.au/print](http://averyproducts.com.au/print)
- Ideal when presentation is important
- Strong plastic tab reinforcement



Code	Software Code	Colour	Description	Size
922002	L7411-5	Multi Coloured <input checked="" type="checkbox"/>	1-5 Tab	A4
922003	L7411-6	Multi Coloured <input checked="" type="checkbox"/>	1-6 Tab	A4
922004 <span style="font-size: small; border: 1px solid red; padding: 1px;">BEST SELLER</span>	L7411-10	Multi Coloured <input checked="" type="checkbox"/>	1-10 Tab	A4
922008	L7411-10	Multi Coloured <input checked="" type="checkbox"/>	1-10 Tab x 6 sets	A4
922005	L7411-12	Multi Coloured <input checked="" type="checkbox"/>	1-12 Tab	A4
922006	L7411-15	Multi Coloured <input checked="" type="checkbox"/>	1-15 Tab	A4
922007	L7411-26	Multi Coloured <input checked="" type="checkbox"/>	A-Z Tab	A4
922000	L7411-5	Multi Coloured <input checked="" type="checkbox"/>	Quarterly Tabs	A4
922001	L7411-6	Multi Coloured <input checked="" type="checkbox"/>	Days of the Week	A4

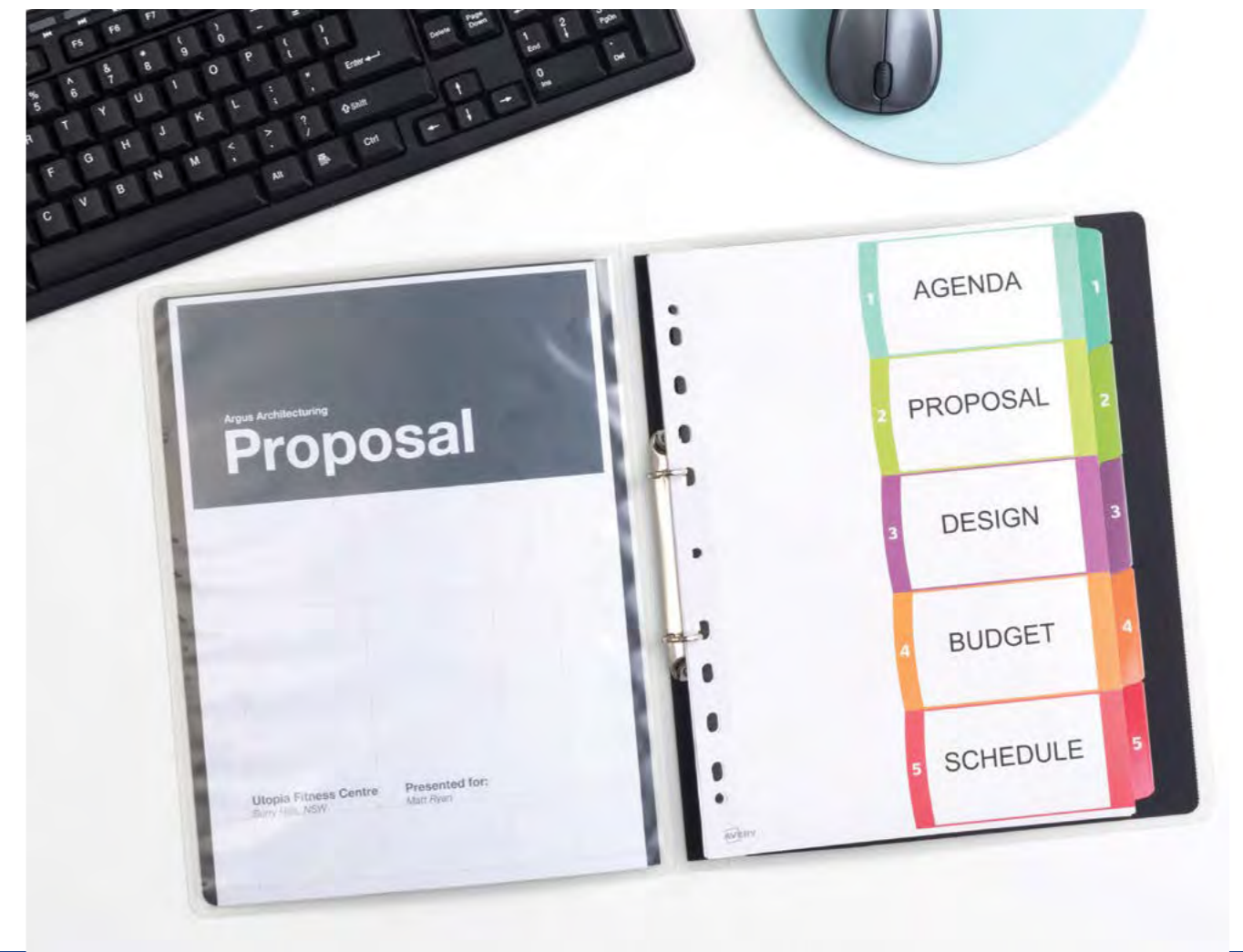

## Dividers with Pre-Printed Tabs



### Ready Index Plastic Dividers Laser / Inkjet

- Fast and easy way to create professional indexes
- Laser or inkjet compatible
- Customise your table of contents with our free and easy-to-use template software; Avery Design and Print – available at [averyproducts.com.au/print](http://averyproducts.com.au/print)
- Ideal for important presentations when indexes are require



Code	Software Code	Colour	Description	Size
920145	L7411-5	Multi Coloured	1-5 Tab	A4
920146	L7411-6	Multi Coloured	1-6 Tab	A4
920147	L7411-10	Multi Coloured	1-10 Tab	A4





### White Plastic Pre-Printed Dividers Laser / Inkjet

- Manufactured from durable polypropylene
- Punched with 11 holes for use in all files and ring binders
- Customise your table of contents with our free and easy-to-use template software; Avery Design and Print – available at [averyproducts.com.au/print](http://averyproducts.com.au/print)
- Ideal for documents which are regularly accessed

**Extra Wide**

- Extra width for use with sheet protectors
- Ideal for documents which are regularly accessed
- Customise your table of contents with our free and easy-to-use template software; Avery Design and Print – available at [averyproducts.com.au/print](http://averyproducts.com.au/print)



Code	Colour	Description	Size
85605	White	<input type="checkbox"/> 1-5 Tab	A4
85610	White	<input type="checkbox"/> 1-10 Tab	A4
85612	White	<input type="checkbox"/> 1-12 Tab	A4
85620	White	<input type="checkbox"/> 1-20 Tab	A4
85631	White	<input type="checkbox"/> 1-31 Tab	A4
85654	White	<input type="checkbox"/> 1-54 Tab	A4
85622	White	<input type="checkbox"/> A-Z Tab	A4
85613	White	<input type="checkbox"/> Jan-Dec Tab	A4
<b>Extra Wide</b>			
85655	White	<input type="checkbox"/> 1-5 Tab	A4
85660	White	<input type="checkbox"/> 1-10 Tab	A4



## Dividers with Pre-Printed Tabs



### Plastic Multi Coloured Dividers

- Made from environmentally friendly polypropylene
- Bright colour polypropylene dividers Ideal for documents which are frequently accessed
- Punched with 11 holes for use in all files and ring binders

**Extra Wide**

- Extra width for use with sheet protectors
- Ideal for documents which are regularly accessed
- Customise your table of contents with our free and easy-to-use template software; Avery Design and Print – available at [averyproducts.com.au/print](http://averyproducts.com.au/print)



Code	Colour	Description	Size
85810	Blue	1-10 Tab	A4
<b>Extra Wide</b>			
85665	Multi Coloured	1-5 Tab	A4
85670	Multi Coloured	1-10 Tab	A4





### Plastic Insertable Dividers

- Blank inserts for tabs provided which can be easily labelled, rearranged or changed
- Manufactured from durable polypropylene
- Ideal for documents which are regularly accessed
- Punched with 11 holes for use in all files and ring binders



Code	Colour	Description	Size
<b>Extra Wide</b>			
85675	Multi Coloured	5 Tab	A4
85690	White	<input type="checkbox"/> 10 Tab	A4



## Manilla Board Dividers

**Pre-Printed Dividers**

- Tear-proof tabs and plastic reinforced spine for durability
- Quality white manilla board
- Ideal for documents which are frequently accessed
- Punched with 11 holes for use in all files and ring binders

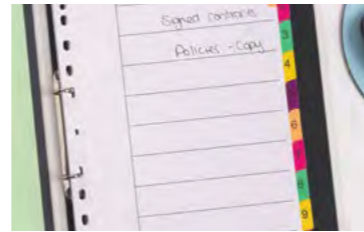

Code	Colour	Description	Size
<b>Fluoro Tabs</b>			
85713	White	Jan-Dec	A4
85723	White	1-10 Tab	A4
85732	White	5 Tab	A4
85743	White	A-Z	A4
85753	White	1-31	A4
<b>Red Blue Tabs</b>			
85742	White	A-Z	A4
<b>Fluoro Tabs</b>			
88710	White	1-10 Tab	A4
88712	White	1-12 Tab	A4
88713	White	Jan-Dec	A4

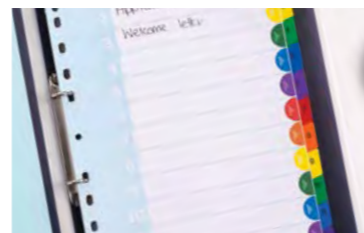
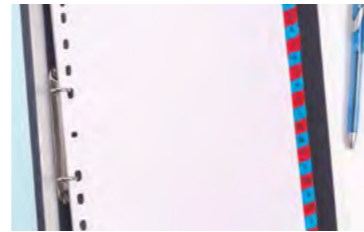

**Write & Erase Multi Coloured Tab Dividers**

- Erasable laminated tabs allows tabs to be reused when you need
- Quality white manilla board
- Plastic reinforced spine for durability
- Multi-punched to fit all standard files and binders



Code	Colour	Description	Size
85600	White	5 Tab	A4
85601	White	10 Tab	A4

**Brightly Multi Coloured Manilla Dividers**

- Colourful tabs in A-Z order
- Manufactured from quality manilla board
- Punched with 11 holes for use in all files and ring binders
- Ideal for single use documents that are to be stored



Code	Colour	Description	Size
97575	Multi Coloured	A-Z Tab	A4
<b>Extra Wide</b>			
97565	Multi Coloured	5 Tab	A4
97570	Multi Coloured	10 Tab	A4



**Evolve your filing system into a highly efficient, vertical space saving solution!**

Avery Lateral Filing is a customisable solution that is unique to the needs of your organisation. The comprehensive range includes cabinets, files and wallets and coding labels which can be tailored to your accessibility and storage requirements. With Avery FilePro software you can automatically code your labels and import your database with ease.



## Lateral Filing Folder Dimensions and Weights Guide

### DIMENSIONS

A4	332 x 242mm
Foolscap	367 x 242mm
Legal	388 x 242mm
Notes / Formakote File Range	355 x 235mm

### WEIGHTS

Heavy Weight	240 – 250gsm
Extra Heavyweight	300 – 325gsm
Super Weight	370 – 380gsm

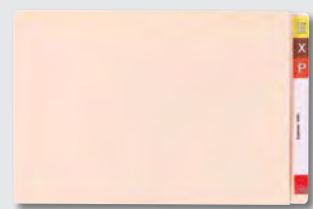

### Shelf Lateral File 35mm expansion – A4

- Manufactured in Heavyweight and Extra Heavyweight manilla board for durability
- Use on an existing shelf unit, cabinet or mobile shelving unit
- Use with Avery colour coding labels or file title labels
- Alternatively, customise file label with Avery FilePro® Software



Code	Size	Colour	Board Type	Box
42713	A4	Buff	Heavyweight	100
46704	A4	Buff	Extra Heavyweight	100
46703	A4	White <input type="checkbox"/>	Extra Heavyweight	100



### Shelf Lateral File 35mm expansion – Foolscap

- Manufactured in Heavyweight and Extra Heavyweight manilla board for durability
- Use on an existing shelf unit, cabinet or mobile shelving unit
- Use with Avery manual colour coding labels or file title labels
- Alternatively, customise file label with Avery FilePro® Software



Code	Size	Colour	Board Type	Box
46501	Foolscap	White <input type="checkbox"/>	Extra Heavyweight	15
46503	Foolscap	White <input type="checkbox"/>	Extra Heavyweight	100
46504	Foolscap	Buff	Extra Heavyweight	100
42513	Foolscap	Buff	Heavyweight	100

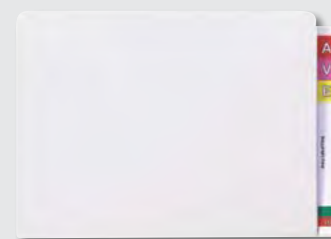

### Shelf Lateral File 35mm expansion – Legal

- Manufactured from extra heavy weight manilla board for durability
- Add a Tubeclip® or Permclip® File Fastener to which allows papers to be secured and easily accessed
- Alternatively, customise file label with Avery FilePro® Software



Code	Size	Colour	Board Type	Box
42520	Legal	White <input type="checkbox"/>	Extra Heavyweight	100
42538	Legal	Buff	Extra Heavyweight	100



### Twin Tab Lateral File 35mm expansion

- Dual purpose file with side tab as well as top tab
- Versatile as it can be used in either a drawer cabinet or on a shelf unit
- Use with Avery manual colour coding labels or file title labels
- Alternatively, customise file label with Avery FilePro® Software



Code	Size	Colour	Board Type	Box
46555	Foolscap	White <input type="checkbox"/>	Extra Heavyweight	100



### Shelf Lateral White File with Colour Mylar end tabs 35mm expansion – Foolscap

- White shelf lateral files with a coloured plastic tear-proof tab
- Add a Tubeclip® or Permclip® File Fastener to which allows papers to be secured and easily accessed
- Tabs are reinforced for durability
- Alternatively, customise file label with Avery FilePro® Software



Code	Size	Colour	Board Type	Box
42421	Foolscap	White with Clear Tab <input type="checkbox"/>	Extra Heavyweight	100
42430	Foolscap	White with Pink Tab <input type="checkbox"/>	Extra Heavyweight	100
42431	Foolscap	White with Red Tab <input type="checkbox"/>	Extra Heavyweight	100
42433	Foolscap	White with Orange Tab <input type="checkbox"/>	Extra Heavyweight	100
42434	Foolscap	White with Light Green Tab <input type="checkbox"/>	Extra Heavyweight	100
42435	Foolscap	White with Dark Green Tab <input type="checkbox"/>	Extra Heavyweight	100
42436	Foolscap	White with Light Blue Tab <input type="checkbox"/>	Extra Heavyweight	100
42437	Foolscap	White with Purple Tab <input type="checkbox"/>	Extra Heavyweight	100
42440	Foolscap	White with Yellow Tab <input type="checkbox"/>	Extra Heavyweight	100



### Shelf Lateral White File with Colour Mylar end tabs 35mm expansion – Legal

- Tabs are reinforced for durability
- Add a Tubeclip® or Permclip® File Fastener to which allows papers to be secured and easily accessed
- Colour coded tab allows for colour coding based on departments, projects, etc
- Alternatively, customise file label with Avery FilePro® Software



Code	Size	Colour	Board Type	Box
42521	Legal	White with Clear Tab <input type="checkbox"/>	Extra Heavyweight	100
42531	Legal	White with Red Tab <input type="checkbox"/>	Extra Heavyweight	100
42533	Legal	White with Orange Tab <input type="checkbox"/>	Extra Heavyweight	100
42534	Legal	White with Light Green Tab <input type="checkbox"/>	Extra Heavyweight	100
42535	Legal	White with Dark Green Tab <input type="checkbox"/>	Extra Heavyweight	100
42536	Legal	White with Light Blue Tab <input type="checkbox"/>	Extra Heavyweight	100
42537	Legal	White with Purple Tab <input type="checkbox"/>	Extra Heavyweight	100
42540	Legal	White with Yellow Tab <input type="checkbox"/>	Extra Heavyweight	100



### Shelf Lateral Solid Coloured 35mm expansion

- Extra heavy weight shelf lateral files are manufactured from strong weight board with a reinforced side tab on which you can label colour code and file title labels
- Use on an existing shelf unit, cabinet or mobile shelving unit
- Use with Avery manual colour coding labels or file title labels
- Alternatively, customise file label with Avery FilePro® Software



Code	Size	Colour	Board Type	Box
45413	Foolscap	Yellow	Extra Heavyweight	100
45113	Foolscap	Red	Extra Heavyweight	100
45213	Foolscap	Blue	Extra Heavyweight	100
45313	Foolscap	Green	Extra Heavyweight	100



### Shelf Lateral White File with Fasteners 35mm expansion

- Each file is fitted with either a Tubeclip or Permclip File Fastener which allows papers to be secured and easily accessed whenever required
- Use with Avery manual colour coding labels or file title labels
- Alternatively, customise file label with Avery FilePro® Software



Code	Size	Colour	Board Type	Box
46510	Tubeclip	White <input type="checkbox"/>	Extra Heavyweight	100
46511	Permclip	White <input type="checkbox"/>	Extra Heavyweight	100



### Shelf Lateral Wallets – Document Wallet with Flap 40mm expansion

- Manufactured from extra heavy weight manilla board for durability
- Ideal for storing documents that cannot be hole-punched such as annual reports, legal and financial documents
- Wallet style with expansion and flap for better storage
- Use with Avery manual colour coding labels or file title labels
- Alternatively, customise file label with Avery FilePro® Software



Code	Size	Colour	Board Type	Box
43950	Foolscap	Buff	Extra Heavyweight	20
43955	Foolscap	White <input type="checkbox"/>	Extra Heavyweight	20



### Shelf Lateral Wallets – Concertina Wallet 100mm expansion

- Manufactured from extra heavy weight manilla board for durability
- Ideal for storing documents that cannot be hole-punched such as annual reports, legal and financial documents
- Wallet style with expansion for better storage
- Use with Avery manual colour coding labels or file title labels
- Alternatively, customise file label with Avery FilePro® Software



Code	Size	Colour	Board Type	Box
43957	Legal	White <input type="checkbox"/>	Extra Heavyweight	25
43958	Foolscap	White <input type="checkbox"/>	Extra Heavyweight	25



### Shelf Lateral Wallets – Top Opening Pocket Wallet 40mm expansion

- Ideal for storage of loose papers
- Extra heavyweight for durability
- Use with Avery manual colour coding labels or file title labels
- Alternatively, customise file label with Avery FilePro® Software



Code	Size	Colour	Board Type	Box
43949	Foolscap	White <input type="checkbox"/>	Extra Heavyweight	20



### Shelf Lateral Notes Files Size 355 x 235mm

- Made from durable formakote board which is a premium weighted file board, providing a high level of durability for filing purposes
- Use with Avery colour coding labels or file title labels
- Alternatively, customise file label with Avery FilePro® Software



Code	Description,	Colour	Board Type	Box
Shelf Lateral file fitted with Tubeclip file fastener 35mm expansion				
46719	White/Brown	<input type="checkbox"/>	Extra Heavyweight	50
Shelf Lateral file 35mm expansion				
46720	White/Brown	<input type="checkbox"/>	Extra Heavyweight	50

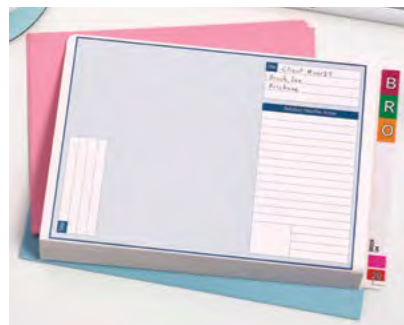

## Shelf Lateral Notes Files Size 355 x 235mm



- Printed panels on the cover to enable notes and related file information to be noted directly onto the file
- Manufactured from heavy weight archival board
- Reinforced side tabs for easy colour code labelling
- Use with Avery manual colour coding labels or file title labels
- Alternatively, customise file label with Avery FilePro® Software

Code	Size	Colour	Board Type	Box
46710	Standard File 35mm expansion	Printed Blue Panels	<input checked="" type="checkbox"/> Extra Heavyweight	100
46711	<b>BEST SELLER</b> Standard File fitted with Tubeclip File Fastener 35mm expansion	Printed Blue Panels	<input checked="" type="checkbox"/> Extra Heavyweight	100
46712	Standard File fitted with Spiral Spring Transfer 40mm expansion	Printed Blue Panels	<input checked="" type="checkbox"/> Superweight	50
46713	Standard file with Left Hand Pocket 35mm expansion	Printed Blue Panels	<input checked="" type="checkbox"/> Extra Heavyweight	20
46714	Twin Tab File 35mm expansion	Printed Blue Panels	<input checked="" type="checkbox"/> Extra Heavyweight	100
46715	Open Top Wallet 40mm expansion	Printed Blue Panels	<input checked="" type="checkbox"/> Extra Heavyweight	20
46716	Twin Tab Pocket Wallet 40mm expansion	Printed Blue Panels	<input checked="" type="checkbox"/> Extra Heavyweight	20
46717	Document Wallet with Flap 40mm expansion	Printed Blue Panels	<input checked="" type="checkbox"/> Extra Heavyweight	20
46718	Concertina Wallet 100mm expansion	White	<input type="checkbox"/> Extra Heavyweight	25

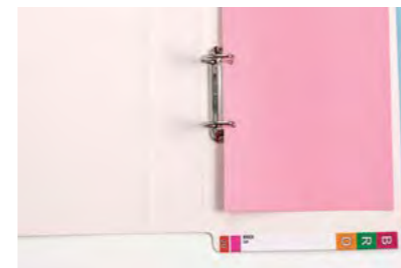
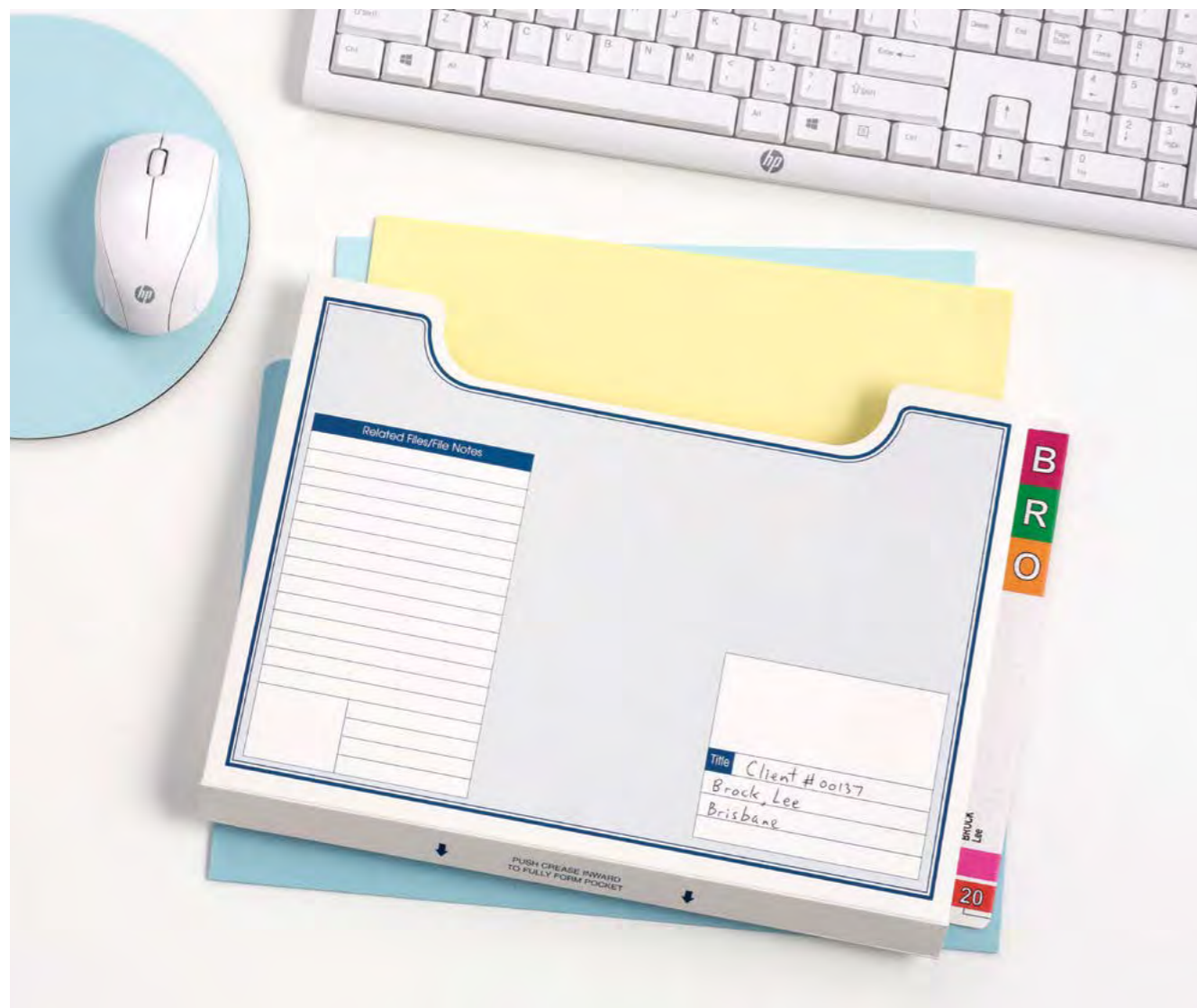

## Lateral Filing Binders – D Ring Lateral Shelf File



- Great alternative to lever arch files
- Ideal for heavy duty filing
- Use with Avery manual colour coding labels or file title labels
- Alternatively, customise file label with Avery FilePro® Software

Code	Size	Colour	Board Type	Box
46513	Heavy Duty D Ring Binder 52mm expansion	White / Brown <input type="checkbox"/> <input checked="" type="checkbox"/>	Heavyweight	15
46514	Super Duty D Ring Binder 52mm expansion	White <input type="checkbox"/>	Superweight	10

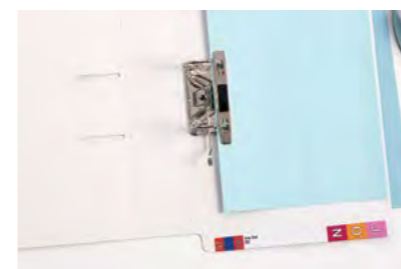

## Lever Arch Lateral Shelf File



- Ideal for heavy duty filing
- Use with Avery manual colour coding labels or file title labels
- Alternatively, customise file label with Avery FilePro® Software

Code	Size	Colour	Board Type	Box
46515	<b>BEST SELLER</b> Lever Arch 70mm expansion	White <input type="checkbox"/>	Superweight	5



## Fullvue Lateral Files



- A unique flap on the front edge that wraps around the file contents
- Fasteners can be installed into the file for further security of documents
- Great for heavy weight documents requiring tab and title visibility
- Alternatively, customise file label with Avery FilePro® Software

Code	Size	Colour	Board Type	Box
165707	Foolscap File with 50mm gusset	White <input type="checkbox"/>	Heavyweight	100
165720	Foolscap File with 30mm gusset	White <input type="checkbox"/>	Heavyweight	100

## Stock Package

### Package 1 – Code No. 20326

- Includes 250 Formakote White Lateral Files (46720)
- 25 Concertina Wallets (46718)
- Avery FilePro Single License Software (40000)
- 400 Avery Lateral Filing Labels (959095)
- File Size 355 x 235mm, 35mm expansion



Package 1

### Package 2 – Code No. 20327

- Includes 500 Foolscap White Lateral Files (46503)
- Avery FilePro 2-10 License Software (40001)
- 800 Avery Lateral Filing Labels (959095)
- File Size 367 x 242mm, 35mm expansion



Package 2

### Package 3 – Code No. A10123

- Includes 300 Foolscap White Lateral files (46503)
- 300 Yellow Tubeclips (44009Y)
- Outguides Pack of 25 (41546)
- 1 Avery FilePro Software (40000)
- 400 Lateral Filing Labels (959095)
- File Size 367 x 242mm, 35mm expansion

### Package 4 – Code No. A20126

- Includes 600 Foolscap White Lateral Files (46503)
- 600 Yellow Tubeclips (44009Y)
- Outguides pack of 25 (41546)
- 1 Avery FilePro Software (40000)
- 400 Lateral Filing Labels (959095)
- File Size 367 x 242mm, 35mm expansion



Package 3 and 4



### Fullvue Lateral File with Colour Tab & Spine 30mm Gusset



- Installed with colour tab and spine for easy identification of file type
- Allows 100% visibility of file tab and title label
- Unique flap on the front edge that wraps around the file contents
- Alternatively, customise file label with Avery FilePro® Software

Code	Description	Colour	Board Type	Box	
165715DGR	Foolscap File with 30mm gusset	White/Dark Green Tab & Spine	<input type="checkbox"/>	Heavyweight	100
165715LBL	Foolscap File with 30mm gusset	White/Light Blue Tab & Spine	<input type="checkbox"/>	Heavyweight	100
165715ORA	Foolscap File with 30mm gusset	White/Orange Tab & Spine	<input type="checkbox"/>	Heavyweight	100
165715PUR	Foolscap File with 30mm gusset	White/Purple Tab & Spine	<input type="checkbox"/>	Heavyweight	100
165715RED	Foolscap File with 30mm gusset	White/Red Tab & Spine	<input type="checkbox"/>	Heavyweight	100
165715YEL	Foolscap File with 30mm gusset	White/Yellow Tab & Spine	<input type="checkbox"/>	Heavyweight	100



### Quickvue Files and Kits



- Cost-effective storage solution for small business or home offices
- Quickvue™ file is the alternative to a suspension filing, and solves the problem of files falling off metal rails
- With Quickvue™ files you can easily identify files thanks to the angled top across each file

Code	Description	Colour	Board Type	Box	
166007	50 Files, 72 File Title Labels	White	<input type="checkbox"/>	Heavyweight	50
49997	Single Drawer Kit: 50 Files, 72 File Title Labels 1 File Rack 500 x 390mm	White	<input type="checkbox"/>	Heavyweight	50
49996	Two Drawer Kit: 100 Files, 144 File Title Labels, 2 File Racks 500 x 390mm	White	<input type="checkbox"/>	Heavyweight	100
49998	Four Drawer Kit: 200 Files, 288 File Title Labels, 4 File Racks 500 x 390mm	White	<input type="checkbox"/>	Heavyweight	200

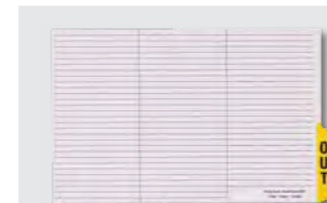

### Outguide

- Outguide with yellow tab for shelf lateral filing system
- Used when a file is removed from a filing system
- Allows the file user to note down to whom, when and where the file is going

Code	Description	Colour	Board Type	Box	
41546	388 x 242mm	White with Yellow Tab	<input type="checkbox"/>	Extra Heavyweight	25



## File Racks – Fold over suitable for 25mm shelf height

- Suitable for shelf filing
- Available in other sizes to fit various cabinets and shelving
- The sturdy metal will not bend under the weight of your bulky documents
- Flexible as fasteners can be applied for further securing documents



Code	Description	Size	Colour	Box
40451	Fold over	750 x 390mm	White	Each
40452	Fold over	900 x 290mm	White	Each
40448	Fold over	900 x 390mm	White	Each
40460	Fold over	1060 x 375mm	White	Each
40454	Fold over	1200 x 390mm	White	Each



## File Racks – Straight Edge

- Fits all shelves including bottom shelf, cupboard, custom built shelves
- Suits a variety of shelves, ideally suitable for bottom shelf, cupboard and custom build shelves
- Use in-conjunction with your lateral files to keep multiple files upright
- The sturdy metal will not bend under the weight of your bulky documents



Code	Description	Size	Colour	Box
40447 <small>BEST SELLER</small>	Straight Edge ( Drawer Cabinet)	500 x 390mm	White	Each
40464	Straight Edge	750 x 390mm	White	Each
40463	Straight Edge	900 x 390mm	White	Each
40462	Straight Edge	1050 x 390mm	White	Each
40461	Straight Edge	1200 x 390mm	White	Each



## File Racks – Desktop Filing Rack

- The desktop file rack is economical in size, easy to move and versatile enough for use on the desk, on cabinets or shelves
- Starter Pack contains 1 x desktop file rack (40465), 10 x shelf lateral files (46503), 1 x sheet of file title labels (45201)
- The file rack can be used with a variety of file types and sizes
- The file rack features a lip at the front to allow you to sit it flush against the desk or on a shelf

Code	Description	Size	Colour	Box
40465	Desk Rack Only	400x200mm	White	Each
40466	Desktop Filing Starter Pack	400x200mm	White	Each

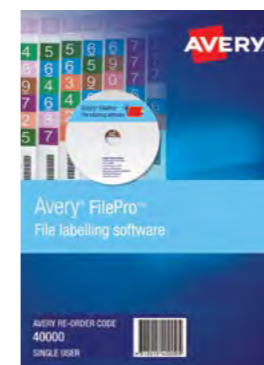

## FilePro File Labelling Software

- Easy to use with pre-designed templates to customise filing labels
- Available for single users, in addition for two to ten users in small to medium offices & 11+ for large organisations
- Use with Avery Auto Lateral Filing Laser Labels L7174
- Print brilliant colour-coded labels for alphabetical, numeric or custom indexed filing systems quickly and easily

Code	Description
40000	Single License
40001	2-10 License
40002	11+ License



## Lateral Filing Strip Label

- Specially designed to fit the tab area of lateral files
- Save time by printing on one label strip rather than applying individual tab labels
- Guaranteed Jam Free laser printing
- Designed for easy file identification
- FSC® certified labels made with paper from well-managed forests

Code	Description	Colour	Size	Labels per Pack
959095	4 Labels per Sheet	White	220 x 42mm	400



## Colour Coding Side Labels Box 500 – Alphabetical

- Easily identify files by using alphabetical side tab colour coding labels
- Apply on the side of your files
- Each letter from A-Z and 'Mc' is given a different colour for easy identification
- Available in sheets to suit your preferences
- Also available in alpha, numeric and year code

Code	Desc.	Colour	Size	Labels per Box
43201	A	Pink	25 x 38mm	500
43202	B	Magenta	25 x 38mm	500
43203	C	Orange	25 x 38mm	500
43204	D	Dark Orange	25 x 38mm	500
43205	E	Yellow	25 x 38mm	500
43206	F	Light Green	25 x 38mm	500
43207	G	Dark Green	25 x 38mm	500
43208	H	Blue	25 x 38mm	500
43209	I	Purple	25 x 38mm	500
43210	J	Mauve	25 x 38mm	500
43211	K	Brown	25 x 38mm	500
43212	L	Mustard	25 x 38mm	500
43213	M	Pink	25 x 38mm	500
43214	N	Magenta	25 x 38mm	500
43215	O	Orange	25 x 38mm	500
43216	P	Dark Orange	25 x 38mm	500
43217	Q	Yellow	25 x 38mm	500
43218	R	Light Green	25 x 38mm	500
43219	S	Dark Green	25 x 38mm	500
43220	T	Blue	25 x 38mm	500
43221	U	Purple	25 x 38mm	500
43222	V	Mauve	25 x 38mm	500
43223	W	Brown	25 x 38mm	500
43224	X	Mustard	25 x 38mm	500
43225	Y	White/Grey	25 x 38mm	500
43226	Z	Grey	25 x 38mm	500
43227	Mc	Black	25 x 38mm	500



## Colour Coding Side Labels Box 500 – Numeric

- For easy identification of files
- Apply on the side of your files
- Each letter from '0-9 is given a different colour
- Also available in sheets to suit your preferences
- Available in alpha, numeric and year code

Code	Desct.	Colour	Size	Labels per Box
43240	0	Pink	25 x 38mm	500
43241	1	Magenta	25 x 38mm	500
43242	2	Orange	25 x 38mm	500
43243	3	Dark Orange	25 x 38mm	500
43244	4	Light Green	25 x 38mm	500
43245	5	Dark Green	25 x 38mm	500
43246	6	Blue	25 x 38mm	500
43247	7	Purple	25 x 38mm	500
43248	8	Mauve	25 x 38mm	500
43249	9	Brown	25 x 38mm	500



## Colour Coding Side Labels Box 500 – Yearly

- For easy identification of files
- Apply on the side of your files
- Each year is given a different colour
- Also available in pack of 180 to suit your preferences

Code	Description	Colour	Size	Labels per Box
43268	18 Year Code	Mauve	25 x 38mm	500
43269	19 Year Code	Brown	25 x 38mm	500
43270	20 Year Code	Pink	25 x 38mm	500



## Colour Coding Side Tab Labels Packs 180 – Alphabetical

- For easy identification of files
- Apply on the side of your files
- Each letter from A-Z, 'Mc' and forward slash is given a different colour for easy identification
- Also available in rolls of 500 to suit your preferences
- Available in alpha, numeric, year code and months

Code	Desct.	Colour	Size	Labels per Box
43301	A	Pink	25 x 38mm	180
43302	B	Magenta	25 x 38mm	180
43303	C	Orange	25 x 38mm	180
43304	D	Dark Orange	25 x 38mm	180
43305	E	Yellow	25 x 38mm	180
43306	F	Light Green	25 x 38mm	180
43307	G	Dark Green	25 x 38mm	180
43308	H	Blue	25 x 38mm	180
43309	I	Purple	25 x 38mm	180
43310	J	Mauve	25 x 38mm	180
43311	K	Brown	25 x 38mm	180
43312	L	Mustard	25 x 38mm	180
43313	M	Pink	25 x 38mm	180
43314	N	Magenta	25 x 38mm	180
43315	O	Orange	25 x 38mm	180
43316	P	Dark Orange	25 x 38mm	180
43317	Q	Yellow	25 x 38mm	180
43318	R	Light Green	25 x 38mm	180
43319	S	Dark Green	25 x 38mm	180
43320	T	Blue	25 x 38mm	180
43321	U	Purple	25 x 38mm	180
43322	V	Mauve	25 x 38mm	180
43323	W	Brown	25 x 38mm	180
43324	X	Mustard	25 x 38mm	180
43325	Y	White/Grey	25 x 38mm	180
43326	Z	Grey	25 x 38mm	180
43327	Mc	Black	25 x 38mm	180
43328	/	White/Black	25 x 38mm	180



## Colour Coding Side Tab Labels Packs 180 – Numeric

- For easy identification of files
- Apply on the side of your files
- Each number from 0-9 is given a different colour for easy identification
- Also available in rolls of 500 to suit your preferences
- Available in alpha, numeric, year code and months

Code	Desct.	Colour	Size	Labels per Box
43340	0	Pink	25 x 38mm	180
43341	1	Magenta	25 x 38mm	180
43342	2	Orange	25 x 38mm	180
43343	3	Dark Orange	25 x 38mm	180
43344	4	Light Green	25 x 38mm	180
43345	5	Dark Green	25 x 38mm	180
43346	6	Blue	25 x 38mm	180
43347	7	Purple	25 x 38mm	180
43348	8	Mauve	25 x 38mm	180
43349	9	Brown	25 x 38mm	180
43368	18 Year Code	Mauve	25 x 38mm	180
43369	19 Year Code	Brown	25 x 38mm	180
43370	20 Year Code	Pink	25 x 38mm	180



## Colour Coding Side Tab Label Starter Kit

- Includes 72 of each alpha and numeric labels
- Apply on the side of your files
- Each alpha and number is given a different colour for easy identification

Code	Desct.	Colour	Size	Labels per Box
43399	Side Tab Colour Coding Label Kit	Assorted	25 x 38mm	72



## Top Tab Coding Labels Pack 150 – Alphabetical

- Easily identify files by using alphabetical top tab colour coding labels Apply on the top of your files
- Each alphabet from A-Z including 'Mc' and forward slash is given a different colour for easy identification
- Suitable for Quickvue™ files or twin tab files

Code	Desct.	Colour	Size	Labels per Box
44401	A	Pink	20 x 30mm	150
44402	B	Magenta	20 x 30mm	150
44403	C	Orange	20 x 30mm	150
44404	D	Dark Orange	20 x 30mm	150
44405	E	Yellow	20 x 30mm	150
44406	F	Light Green	20 x 30mm	150
44407	G	Dark Green	20 x 30mm	150
44408	H	Blue	20 x 30mm	150
44409	I	Purple	20 x 30mm	150
44410	J	Mauve	20 x 30mm	150
44411	K	Brown	20 x 30mm	150
44412	L	Mustard	20 x 30mm	150
44413	M	Pink/Stripe	20 x 30mm	150
44414	N	Magenta/Stripe	20 x 30mm	150
44415	O	Orange/Stripe	20 x 30mm	150
44416	P	Dark Orange/Stripe	20 x 30mm	150
44417	Q	Yellow/Stripe	20 x 30mm	150
44418	R	Light Green/Stripe	20 x 30mm	150
44419	S	Dark Green/Stripe	20 x 30mm	150
44420	T	Blue/Stripe	20 x 30mm	150
44421	U	Purple/Stripe	20 x 30mm	150
44422	V	Mauve/Stripe	20 x 30mm	150
44423	W	Brown/Stripe	20 x 30mm	150
44424	X	Mustard/Stripe	20 x 30mm	150
44425	Y	White/Grey	20 x 30mm	150
44426	Z	Grey	20 x 30mm	150
44427	Mc	Black /Stripe	20 x 30mm	150
44428	/	White/Black	20 x 30mm	150



## Top Tab Coding Label Starter Kit

Code	Desct.	Colour	Size	Labels per Box
43300	Label Starter Kit	Assorted	20 x 30mm	60 Alpha & Numeric Labels

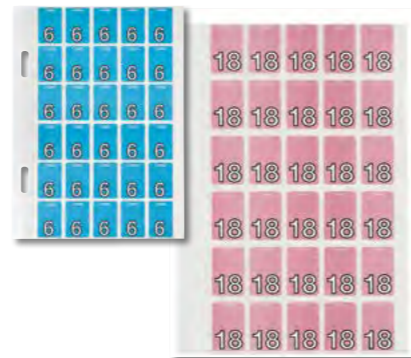

## Top Tab Coding Labels Pack 150 – Numeric

- Easily identify files by using numeric top tab colour coding labels Apply on the top of your files
- Each number from 0-9 is given a different colour for easy identification
- Suitable for Quickvue™ files or twin tab files

Code	Desct.	Colour	Size	Labels per Box
44200	0	Pink	20 x 30mm	150
44201	1	Magenta	20 x 30mm	150
44202	2	Orange	20 x 30mm	150
44203	3	Dark Orange	20 x 30mm	150
44204	4	Light Green	20 x 30mm	150
44205	5	Dark Green	20 x 30mm	150
44206	6	Light Blue	20 x 30mm	150
44207	7	Purple	20 x 30mm	150
44208	8	Mauve	20 x 30mm	150
44209	9	Brown	20 x 30mm	150
44238	18 Year Code	Mauve	20 x 30mm	150
44239	19 Year Code	Brown	20 x 30mm	150
44240	20 Year Code	Pink	20 x 30mm	150



## Series 4 Colour Coding Side Tab Labels Pack 240 – Alphabetical

- Apply on the side of your files
- Each alpha from A-Z including 'Mc' is given a different colour for easy identification
- Colour coding makes it easier to find files and eliminate misfiling

Code	Desct.	Colour	Size	Labels per Box
44501	A	Red	25 x 42mm	240
44502	B	Dark Green	25 x 42mm	240
44503	C	Yellow	25 x 42mm	240
44504	D	Blue	25 x 42mm	240
44505	E	Grey	25 x 42mm	240
44506	F	Pink	25 x 42mm	240
44507	G	Brown	25 x 42mm	240
44508	H	Light Green	25 x 42mm	240
44509	I	Orange	25 x 42mm	240
44510	J	Purple	25 x 42mm	240
44511	K	Red	25 x 42mm	240
44512	L	Dark Green	25 x 42mm	240
44513	M	Yellow	25 x 42mm	240
44514	N	Purple	25 x 42mm	240
44515	O	Blue	25 x 42mm	240
44516	P	Grey	25 x 42mm	240
44517	Q	Light Green	25 x 42mm	240
44518	R	Pink	25 x 42mm	240
44519	S	Brown	25 x 42mm	240
44520	T	Orange	25 x 42mm	240
44521	U	Red	25 x 42mm	240
44522	V	Dark Green	25 x 42mm	240
44523	W	Blue	25 x 42mm	240
44524	X	Pink	25 x 42mm	240
44525	Y	Purple	25 x 42mm	240
44526	Z	Light Green	25 x 42mm	240
44527	Mc	Brown	25 x 42mm	240

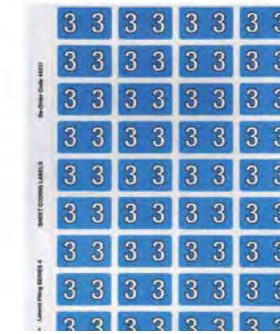

## Series 4 Colour Coding Side Tab Labels Pack 240 – Numeric

- Apply on the side of your files
- Each number from 0-9 is given a different colour for easy identification
- Colour coding makes it easier to find files and eliminate misfiling

Code	Desct.	Colour	Size	Labels per Box
44528	0	Red	25 x 42mm	240
44529	1	Dark Green	25 x 42mm	240
44530	2	Yellow	25 x 42mm	240
44531	3	Blue	25 x 42mm	240
44532	4	Grey	25 x 42mm	240
44533	5	Pink	25 x 42mm	240
44534	6	Brown	25 x 42mm	240
44535	7	Light Green	25 x 42mm	240
44536	8	Orange	25 x 42mm	240
44537	9	Purple	25 x 42mm	240



## Series 4 Side Tab Label Starter Kit

- Apply on the side of your file
- Colour coding makes it easier to find files and eliminate misfiling

Code	Desct.	Colour	Size	Labels per Box
44538	Starter Kit Alpha	Assorted	25 x 42mm	1 sheet of each A-Z = 1040 labels
44539	Starter Kit Numeric	Assorted	25 x 42mm	1 sheet of each 0-9 = 400 labels



### Solid Colour Only Labels

- Apply on the side or top of your files
- Suitable for lateral file segregation for easy identification
- Available in 10 different colours
- Work best together with other colour code labels

Code	Colour	Size	Labels per Box
44540	Black	19 x 42mm	240
44541	Brown	19 x 42mm	240
44542	Dark Green	19 x 42mm	240
44543	Light Green	19 x 42mm	240
44544	Orange	19 x 42mm	240
44545	Pink	19 x 42mm	240
44546	Purple	19 x 42mm	240
44547	Red	19 x 42mm	240
44548	Yellow	19 x 42mm	240
44549	Light Blue	19 x 42mm	240



### Month Coding Labels

- Identify the right record with month coding labels
- Apply on the side of your files
- Each month from 'Jan' to 'Dec' is given different colour for easy identification
- Works best together with year code for financial and accounting records

Code	Desct.	Colour	Size	Labels per Box
43401	January	Pink	23 x 38mm	180
43402	February	Magenta	23 x 38mm	180
43403	March	Orange	23 x 38mm	180
43404	April	Dark Orange	23 x 38mm	180
43405	May	Yellow	23 x 38mm	180
43406	June	Light Green	23 x 38mm	180
43407	July	Dark Green	23 x 38mm	180
43408	August	Blue	23 x 38mm	180
43409	September	Purple	23 x 38mm	180
43410	October	Mauve	23 x 38mm	180
43411	November	Brown	23 x 38mm	180
43412	December	Mustard	23 x 38mm	180



## Avery Lateral Filing Systems can save up to **70%** more office space?

### Conventional Filing Cabinet



- Low initial outlay but higher long term costs and ineffective solution
- Manufactured offshore – cheaper quality
- Takes up more floor space
- More time consuming to locate files
- Potential safety hazard if weight is uneven

### Lateral Filing Cabinet

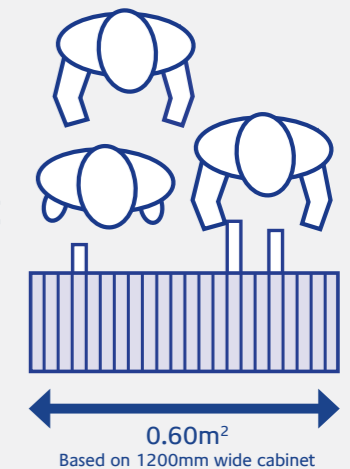

- Moderate initial outlay but more cost-effective long term solution
- Australian made – sturdy construction
- Saves up to 70% floor space
- Colour coding makes locating files easier
- Reduces misfiling & filing time by 50%



## Lateral Filing Cabinet Packages



White

**Code**  
20261/A20126

**Cabinet Colour**

20261OG	Oyster Grey	
20261MA	Magnolia	
20261WHT	White	
20261GR	Graphite Ripple	

**Cabinet Size**  
1980mm H x 1200mm W x 500mm D

**Description**  
Lateral Filing Cabinet Package

- 1 lockable door cabinet with 5 adjustable shelves, 18 shelf dividers, 6 gear stops
- Kit includes: 600 extra heavy weight white foolscap lateral files (46503), 600 Tubeclip® file fasteners (44009Y)
- 25 Outguides (41546) – Used when a file is removed from a filing system
- 1 single user Avery FilePro® software (40000) and 400 lateral filing labels (959095)



Oyster Grey

**Code**  
20262/A10123

**Cabinet Colour**

20262OG	Oyster Grey	
20262MA	Magnolia	
20262WHT	White	
20262GR	Graphite Ripple	

**Cabinet Size**  
1000mm H x 1200mm W x 500mm D

**Description**  
Lateral Filing Cabinet Package

- 1 lockable door cabinet with 2 adjustable shelves, 3 rear stops and 9 shelf dividers
- Kit includes: 300 extra heavy weight white foolscap lateral files (46503), 300 Tubeclip® file fasteners (44009Y)
- 25 Outguides (41546) – Used when a file is removed from a filing system
- 1 single user Avery FilePro® software (40000) and 400 lateral filing labels (959095)



Magnolia

**Code**  
20263/A20126

**Cabinet Colour**

20263OG	Oyster Grey	
20263MA	Magnolia	
20263WHT	White	
20263GR	Graphite Ripple	

**Cabinet Size**  
1980mm H x 900mm W x 500mm D

**Description**  
Lateral Filing Cabinet Package

- 1 lockable door cabinet with 5 adjustable shelves, 18 shelf dividers, 6 gear stop
- Kit includes: 600 extra heavy weight white foolscap lateral files (46503), 600 Tubeclip® file fasteners (44009Y)
- 25 Outguides (41546) – Used when a file is removed from a filing system
- 1 single user Avery FilePro® software (40000) and 400 lateral filing labels (959095)

## Lateral Filing Cabinet Packages



Graphite Ripple

**Code**  
20264/A10123

**Cabinet Colour**

20264OG	Oyster Grey	
20264MA	Magnolia	
20264WHT	White	
20264GR	Graphite Ripple	

**Cabinet Size**  
1000mm H x 900mm W x 500mm D

**Description**  
Lateral Filing Cabinet Package

- 1 lockable door cabinet with 2 adjustable shelves and the base of cabinet, 3 rear stops, and 9 shelf dividers
- Kit includes: 300 extra heavy weight white foolscap lateral files (46503), 300 Tubeclip® file fasteners (44009Y)
- 25 Outguides (41546) – Used when a file is removed from a filing system
- 1 single user Avery FilePro® software (40000) and 400 lateral filing labels (959095)



Oyster Grey

**Code**  
20318/A20126

**Cabinet Colour**

20318OG	Oyster Grey	
20318MA	Magnolia	
20318GR	Graphite Ripple	

**Cabinet Size**  
1980mm H x 1200mm W x 500mm D

**Description**  
Open Bay Filing Package

- 1 open cabinet with 5 adjustable shelves, 18 shelf dividers and 6 rear stops
- Kit includes: 600 extra heavy weight white foolscap lateral files (46503), 600 Tubeclip® file fasteners (44009Y)
- 25 Outguides (41546) – Used when a file is removed from a filing system
- 1 single user Avery FilePro® software (40000) and 400 lateral filing labels (959095)



Magnolia

**Code**  
20319/A20126

**Cabinet Colour**

20319OG	Oyster Grey	
20319MA	Magnolia	
20319GR	Graphite Ripple	

**Cabinet Size**  
1980mm H x 900mm W x 500mm D

**Description**  
Open Bay Filing Package

- 1 open cabinet with 5 adjustable shelves and the base of cabinet, 6 x 40454 (file rack)
- Kit includes: 600 extra heavy weight white foolscap lateral files (46503), 600 Tubeclip® file fasteners (44009Y)
- 25 Outguides (41546) – Used when a file is removed from a filing system
- 1 single user Avery FilePro® software (40000) and 400 lateral filing labels (959095)

## Drawer Filing Packages



Oyster Grey

**Code**

20252/49996

**Cabinet Colour**

- 20252OG Oyster Grey
- 20252MA Magnolia
- 20252GR Graphite Ripple

**Cabinet Size**

715mm H x 467mm W x 610mm D

**Description**

Quickvue 2 Drawer Filing Cabinet Package

- 2 drawer filing cabinet
- Kit includes:
  - 2 x 166007 (100 Quickvue™ files),
  - 1 x 43300 (complete label kit – top tab),
  - 144 x file title labels (8 sheets),
  - 2 x 40447 (file rack 500 x 390mm)
- Use with Quickvue™ files which are designed to eliminate the problem of files falling off metal rails and files bending



Oyster Grey

**Code**

20251/49998

**Cabinet Colour**

- 20251OG Oyster Grey
- 20251MA Magnolia
- 20251GR Graphite Ripple

**Cabinet Size**

1325mm H x 467mm W x 610mm D

**Description**

Quickvue 4 Drawer Filing Cabinet Package

- 4 drawer filing cabinet
- Kit includes:
  - 4 x 166007 (200 Quickvue™ files),
  - 1 x 43300 (complete label kit – top tab),
  - 288 x File title labels (16 sheets),
  - 4 x 40447 (file rack 500 x 390mm)
- Use with Quickvue™ files which are designed to eliminate the problem of files falling off metal rails and files bending



# Presentation

Wow the audience with your presentation and create a good first impression when it really matters.

Create a professional look & add your own style with our range of display books, binders, document wallets, presentation files and handy pouches. Great for home, office or student applications, there is a solution tailored to your individual needs.

### Handy Pouches

- Made from tear proof and water resistant clear PVC reinforced nylon
- Strong and durable to protect books, folders, files, pens, pencils and more
- Zip closure secures and protects contents
- Available in a range of sizes

Code	Colour	Description	Size
49500	Clear PVC	Zip	A3
49501	Clear PVC	Zip	A4
49502	Clear PVC	Zip	A5
49503	Clear PVC	Zip	325 x 145mm



### Insertable Cover Display Book

- Customise the insert front cover
- Includes reversible spine label
- Made from durable polypropylene
- Suitable for presentation and storage

Code	Colour	Description	Size
47931	Navy	20 Pockets	A4
47932	Black	20 Pockets	A4
47935	Navy	40 Pockets	A4
47936	Black	40 Pockets	A4
47937*	Black	60 Pockets	A4

\* Protective case for easy storage

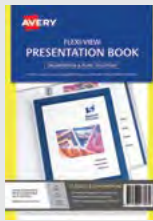

### Flexi View Display Book Clear Insertable Cover

- Clear window allows customising of front and inside cover
- Printed frames adds design and finish
- Customise the title page using software and templates from [www.averyproducts.com.au](http://www.averyproducts.com.au)
- Ideal for creating high quality, professional presentations and proposals
- Made from durable, non-stick polypropylene

Code	Colour	Description	Size
47693	Blue	24 Pockets	A4



### Flexi View Binders

- Clear window allows customising of front and inside cover
- Printed frames adds design and finish
- Customise your title page with our free and easy-to-use template software; Avery Design and Print – available at [averyproducts.com.au/print](http://averyproducts.com.au/print)
- Holds 100 pages
- Made from durable, non-stick polypropylene

Code	Colour	Description	Size
15766	Navy	2 Ring 1/2 inch	A4
15767	Black	2 Ring 1/2 inch	A4



### Soft Cover Display Book

- Flexible soft cover display books
- Colour code your files and documents
- Insert pocket on inside covers
- Made from durable polypropylene

Code	Colour	Description	Size
49112	Blue	20 Pockets	A4
49113	Clear	20 Pockets	A4



### Insert Cover Extra Wide Management File

- Extra wide files to fit copy safe pockets and dividers
- Customise the insert front cover
- Store additional documents in the half pocket inside the back cover
- Colour code your files and documents
- Made from durable polypropylene

Code	Colour	Description	Size
49020	Black	Holds 50 Sheets	A4

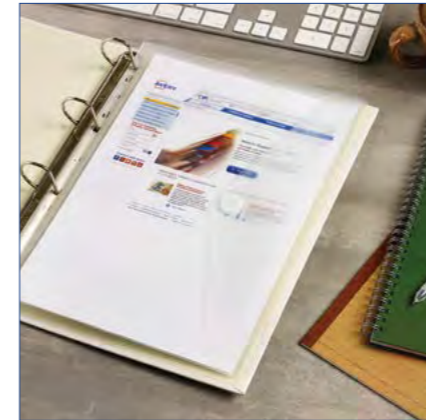
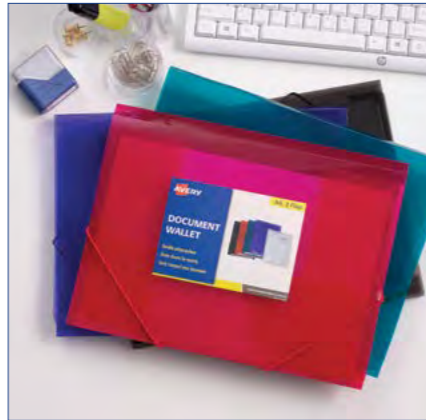

### Translucent Document File

- Holds 200 sheets
- Elastic closures for security
- Made from durable polypropylene

Code	Colour	Description	Size
47709	Red <span style="color:red">■</span>	Capacity 25mm	A4
47712	Clear <span style="border: 1px solid black; display: inline-block; width: 10px; height: 10px;"></span>	Capacity 25mm	A4



### Plastic Wallet & Binder

- Multi-punched filing strip to suit all 2, 3 and 4 ring binders
- Hook and loop fastener to secure documents
- Made from durable polypropylene

Code	Colour	Description	Size
47900 <span style="color:red">BEST SELLER</span>	Clear <span style="border: 1px solid black; display: inline-block; width: 10px; height: 10px;"></span>	11 Hole Punch	Foolscap



### Polypropylene Document Wallets

- Holds 200 sheets
- Easily transport your documents
- Elastic closures for security
- Made from durable polypropylene

Code	Colour	Description	Size
47707	Assorted <span style="color:blue">■</span> <span style="color:green">■</span> <span style="color:red">■</span> <span style="color:black">■</span>	3 Flap Wallet	A4
47708	Clear <span style="border: 1px solid black; display: inline-block; width: 10px; height: 10px;"></span>	3 Flap Wallet	A4



### Clear Zip Document Pouch

- Zip closure secures and protects contents
- Made from durable polypropylene
- Expands to 30mm

Code	Colour	Description	Size
47728	Clear <span style="border: 1px solid black; display: inline-block; width: 10px; height: 10px;"></span>	Zip	A4



### Transparent Document Wallets

- Hook and loop fastener to secure documents
- Made from durable polypropylene
- Lightweight and hard wearing so you don't have to worry about your contents being damaged



Code	Colour	Description	Size
47770	Blue <span style="color:blue">■</span>	Hook & Loop Fastener	Foolscap
47771	Clear <span style="border: 1px solid black; display: inline-block; width: 10px; height: 10px;"></span>	Hook & Loop Fastener	Foolscap



### Assorted Colour Lock Files

- Includes one file of each colour – purple, green, red, blue and orange
- Allows papers to be secured without the need for hole punching
- Innovative corner lock prevents pages from falling out
- Manufactured from durable polypropylene

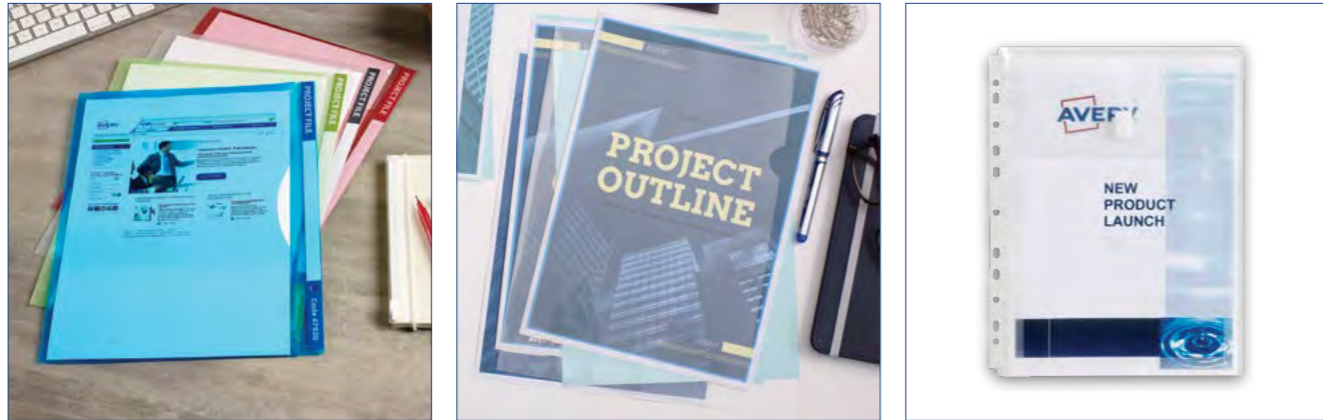
Code	Colour	Description	Size
68020	Assorted <span style="color:purple">■</span> <span style="color:green">■</span> <span style="color:red">■</span> <span style="color:blue">■</span> <span style="color:orange">■</span>	Holds 20 Sheets	A4

**Transparent Project Files**

- Reversible colour coded strip
- Flap secure contents
- Durable polypropylene

Code	Colour	Description	Size
47920	Blue	Holds 20 Sheets	A4
47921	Clear	Holds 20 Sheets	A4
47922	Green	Holds 20 Sheets	A4
47923	Red	Holds 20 Sheets	A4



**Transparent Letter File**

- Made from durable polypropylene
- Thumb cut opening for easy access to documents

Code	Colour	Description	Size
47941	Clear	Holds 20 Sheets	A4



**Presentation Accessories**

- Ideal for school or office
- Folder-friendly – fits all 2, 3 and 4 ring binders
- Made from durable polypropylene

Code	Colour	Description	Size
47901	Clear	Sheet Protector Heavy Duty	A4
47902	Clear	Expandable Pocket 30mm, 11 hole punch	A4



Whether you're looking for a way to ensure your mailing information is clear, bringing your products to life or making a gift extra special we have the tag for you!

Browse through our range of shipping, coloured and price Tags for any project big or small.

### Buff Tags

- For easy identification
- Manufactured from quality manilla board
- Reinforced holes for durability
- Supplied in bundles of 4 slightly connected tags that separate easily
- Use for craft projects, gift tags and warehousing

Code	Colour	Descr.	Size	Tag Per Box
<b>Small Packs</b>				
11100	Buff	Size 1	70 x 35mm	10
13100	Buff	Size 3	96 x 48mm	10
14100	Buff	Size 4	108 x 54mm	10
15100	Buff	Size 5	120 x 60mm	10
<b>Bulk Packs</b>				
11000	Buff	Size 1	70 x 35mm	1000
12000	Buff	Size 2	82 x 41mm	1000
13000	Buff	Size 3	96 x 48mm	1000
14000	Buff	Size 4	108 x 54mm	1000
15000	Buff	Size 5	120 x 60mm	1000
16000	Buff	Size 6	134 x 67mm	1000
17000	Buff	Size 7	146 x 73mm	1000
18000	Buff	Size 8	160 x 80mm	1000

### Coloured Tags

- For easy identification
- Manufactured from quality manilla board
- Reinforced holes for durability
- Supplied in bundles of 4 slightly connected tags that separate easily
- Use for craft projects, gift tags and warehousing

Code	Colour	Descr.	Size	Tag Per Box
14551	Red	Size 4	108 x 54mm	50
14552	Blue	Size 4	108 x 54mm	50
14556	White	Size 4	108 x 54mm	50
14110	Red	Size 4	108 x 54mm	1000
14120	Blue	Size 4	108 x 54mm	1000
14130	Green	Size 4	108 x 54mm	1000
14140	Yellow	Size 4	108 x 54mm	1000
14150	Pink	Size 4	108 x 54mm	1000
14160	White	Size 4	108 x 54mm	1000
15110	Red	Size 5	120 x 60mm	1000
15120	Blue	Size 5	120 x 60mm	1000
15130	Green	Size 5	120 x 60mm	1000
15140	Yellow	Size 5	120 x 60mm	1000
16110	Red	Size 6	134 x 67mm	1000
16120	Blue	Size 6	134 x 67mm	1000
16130	Green	Size 6	134 x 67mm	1000
16140	Yellow	Size 6	134 x 67mm	1000
16160	White	Size 6	134 x 67mm	1000
18110	Red	Size 8	160 x 80mm	1000
18120	Blue	Size 8	160 x 80mm	1000
18130	Green	Size 8	160 x 80mm	1000
18140	Yellow	Size 8	160 x 80mm	1000
18160	White	Size 8	160 x 80mm	1000
18170	Orange	Size 8	160 x 80mm	1000

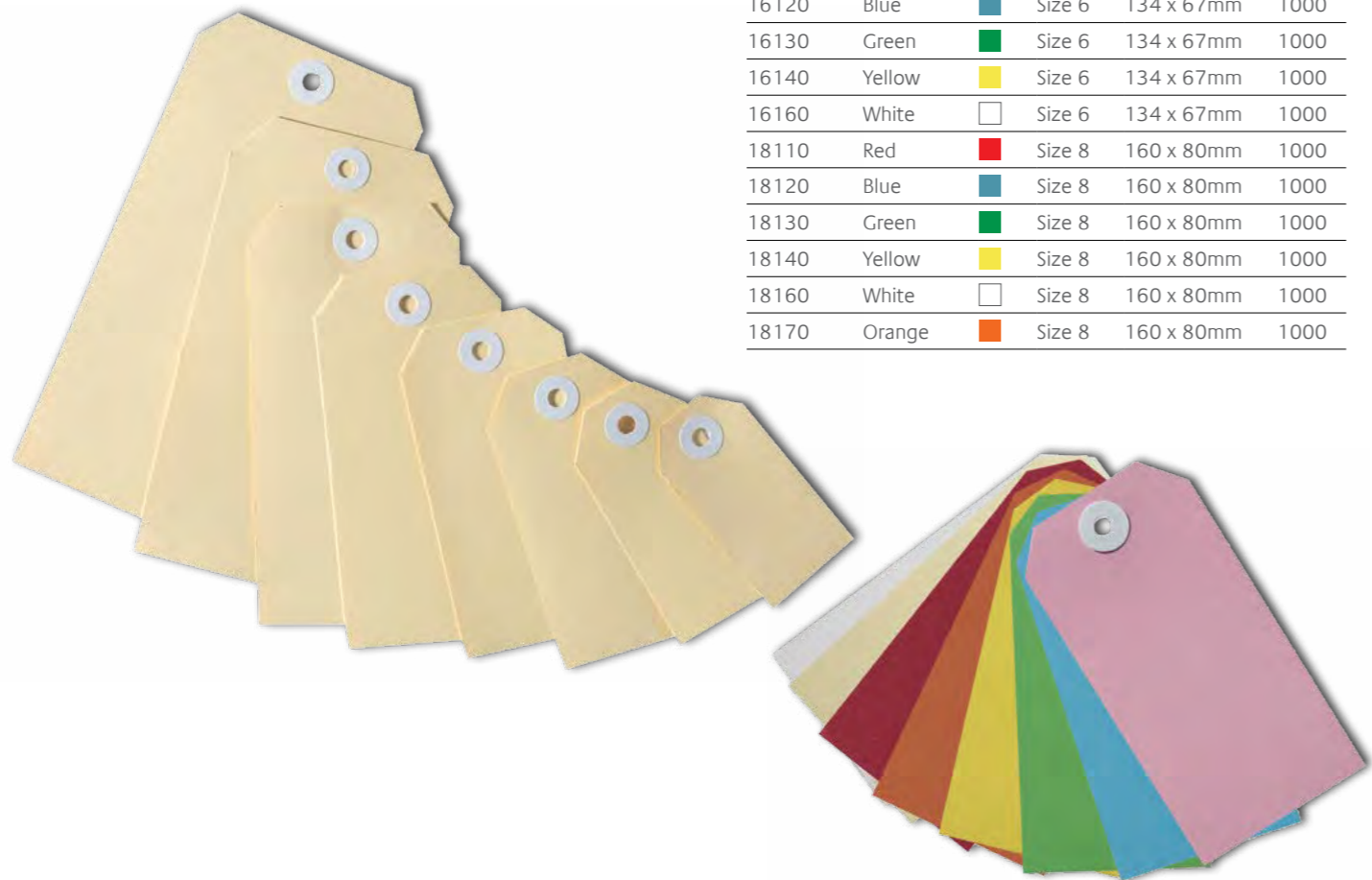

### Printable Tags Laser / Inkjet

- Double-sided printing with room for logo, messaging, pricing or barcode
- Includes prepunched holes and premium-style fabric string with a quick-latch fastener for easy and secure attachment
- Customise your tags with our free and easy-to-use template software; Avery Design and Print – available at [averyproducts.com.au/print](http://averyproducts.com.au/print)
- High quality durable card



Code	Software Code	Description	Size	Tags per Pack	Sheets per Pac	Tags per sheet
980050	22848	Scallop (double sided print)	50 x 32mm	90	5	18

### Merchandise Tags

- Ideal for retail point-of-sale, markets and garage sales
- Perfect alternative to adhesive labels that may not be suitable for some merchandise items
- Made from high quality, heavy gauge white board and strung with twine, knotted at one end for easy attachment
- Use for small and fiddly items that require a smaller tag



Code	Colour	Description	Size	Tags per Box
993613	White	Size 13AH	17 x 7mm	1000
993621	White	Size 21AH	21 x 13mm	1000
993623	White	Size 23H	30 x 21mm	1000
993624	White	Size 24H	37 x 23mm	1000
993626	White	Size 26H	47 x 30mm	1000



### Tags with String

- 6 popular colours to choose from for any occasion
- Reinforced hole keeps tag attached without tearing
- Good all purpose tags include 6" vanilla strings for quick tagging convenience
- Supplied in a convenient 24 pack perfect for any project
- Use for craft projects or gift tags



Code	Colour	Description	Size	Tags per Pack
13200	Brown Kraft	Size 3	96 x 48mm	24
13201	Pastel Pink	Size 3	96 x 48mm	24
13202	Pastel Blue	Size 3	96 x 48mm	24
13203	Pastel Green	Size 3	96 x 48mm	24
13204	Pastel Peach	Size 3	96 x 48mm	24
13205	Pastel Yellow	Size 3	96 x 48mm	24

Avery Term	Definition
Avery Design & Print Online	Using Avery Design & Print Online, you can add text, messages, images, and logos to any template and instantly print to create your perfect design. Start with a blank label and take full creative license, or tweak one of our many pre-designed templates to suit your needs.
Easy Apply™ Strips	Save time with the Easy Apply™ strips that let you print and apply all the tab labels at once onto the tabs rather than sticking them on one-by-one, making it simple to create custom dividers right from your desktop for a professional finish.
FSC Certified	FSC certification assures the consumer the product materials were sourced from responsibly managed forests. When you see an FSC logo on a product you can buy with the confidence that you are helping to ensure our forests are alive for generations to come.
Jam Free Guarantee	The Avery JamFree guarantee means that your product is produced and formatted in a way that prevents adhesives bleeding into your printer. This will give you peace of mind by ensuring no printer jams due to adhesive build up.
Mail Merge	A process which takes data from one source and applies it to another. By using Avery's Import Data feature you can rearrange information into a new format at the touch of a few buttons. Mail merging is perfect for producing address labels, invitations and mass mailings, and Avery's free Design & Print software includes this feature within it.
Mylar Dividers	Mylar dividers have reinforced holes and tabs for extra strength so you can use them time and time again. In addition, they are available in various tab formats, including numbered, lettered and plain tabs which are brightly coloured for easy identification.
NoPeel Labels	If an attempt has been made to remove the label the material flakes and disintegrates, making removal virtually impossible and tampering immediately visible.
Print & Divide	A perforated backing card for individual separation of the name badges, these can be sorted into sections before application and when required your attendees can apply their own badge themselves.
Print-to-the-edge	Gives you the ability to add a full-colour background to your labels to make your products really stand out and look professional.
Quick & Clean™	Avery Quick & Clean™ technology allows you to easily remove your product business cards from the sheet, leaving a completely straight and clean edge to give your business that professional image.
Permanent Labels	Avery permanent labels can be trusted to stay exactly where you left them, every time you need them. The permanent adhesive keeps the label securely in place making it ideal for parcels, branding, gifts or other applications where a label is carrying important information.
Pre-Printed Tabs	Pre-Printed Tabs mean your dividers are instantly ready to go. Numbers, letters, or months will give you an immediate system to help you to organise your filing.
Print & Divide	A perforated backing card for individual separation of the name badges, these can be sorted into sections before application and when required your attendees can apply their own badge themselves.
Printable on both sides	For products that won't be stuck down, why not present your creative designs on both sides to really show off. Create and print text and designs on both sides to spread your message in a more dimensional way.
Print-to-the-edge	Gives you the ability to add a full-colour background to your labels to make your products really stand out and look professional.
Quick & Clean™	Avery Quick & Clean™ technology allows you to easily remove your product from the sheet, leaving a completely straight and clean edge.
Quick Peel™ Labels	The unique QuickPeel™ feature allows labels to be easily taken from the sheet by removing a strip of the backing paper, revealing the edge of each label. You will never have to go through the pain of picking away at the corner of a label again!

Avery Term	Definition
Removable Labels	Perfect for your short term labelling requirements. They are easy to peel and apply and the removable adhesive sticks to glass, plastic and paper and when removed, no sticky residue is left behind.
Rewritable Labels	Avery Rewritable Labels are made from dry erase material, which means they are rewritable and removable making them perfect for temporary or permanent identification. Just wipe clean and rewrite when needed with a dry erase marker to easily update the label.
Self-Laminating Labels	Self-laminating labels will survive the harsh environments of both the dishwasher and the freezer. Identify lunchboxes or foodstorage boxes and be confident your labels will stay put. The self-laminating feature protects your writing and helps keep the label surface clean and protected. Just write, seal and stick.
Smooth Feed	High volume label users need labels designed for speed and high volume use. Avery Address Label with Smooth Feed are for frequent printing of labels for letters and envelopes, and are developed for high volume, high speed printers. The unique Avery Smooth Feed Edges and Jam-Free™ promise mean flawless high speed printing, even in high speed printers and copiers. That means faster, easier mailing!
Smudge Free Labels	Print and use straight away with Smudge Free Labels. Ink dries instantly to avoid smudging when handling and applying your labels, saving you time.
Style Edge™	A fun, stylish way to divide papers in your binder or planner, Style Edge™ tabs offer a unique oval design with a modern look and 5 fresh colours to help make the tabs stand out. They also have a clever notch feature which prevents your title inserts from falling out.
Thermal Roll Labels	Thermal Roll Labels are ideal for use in warehousing and facilities for creating and printing product and inventory labels for quick and easy identification.
TripleBond Labels	Provides three times stronger adhesion than a standard paper label.
TrueBlock Labels	Avery Trueblock® technology creates a completely opaque barrier to hide whats underneath your label, whether it's an old label from pre-used packaging or a pattern on the box, Blockout will allow you to re-use that old box or envelope and make it look new.
Ultra-Resistant Labels	Resistant to Chemicals, UV and saltwater. Engineered for harsh environments.
Water Resistant labels	Tough, durable labels which withstand outdoor environments.
Weatherproof	Weatherproof Labels stand up to tough weather and temperature conditions and resist scuffs, tears and smudges so they remain easy to read.



Every label tells a story...



[averyproducts.com.au](http://averyproducts.com.au)

Avery Products Australia  
11 Carrington Road, Castle Hill, NSW 2154  
Australia: 1800 644 353  
New Zealand: 0800 228 379

© 2017 Avery Products Pty Ltd. All rights reserved